

# Slim Mech

Single Lift Up Door System



Greenply

samet

*Simply Perfect  
Completely Nature*

Introducing the latest addition to the SAMET Lift-Up Door Systems, Slim Mech is meticulously designed to perform the ultimate customer experience in all living areas. With its ergonomic design providing maximum usable space and an advanced mechanical system, it showcases top-tier performance.



### **Aesthetic Design that Blends with Living Spaces**

---

Slim Mech, with its well-thought-out minimalist design, adds elegance and aesthetics to cabinets. The superior-quality nickel coating not only enhances its stylish appearance but also ensures years of use.



## Perfect Silent and Soft-Closing

---

LGA-certified Slim Mech mechanisms, combined with LGA-certified Master Hinge Systems, ensure high performance and quiet operation for the lift-up doors.



## Easy-to-Use in All Living Areas

---

With four different spring force options, Slim Mech adapts to various living spaces and cabinets of different sizes. The power adjustment feature allows it to exhibit the best performance.

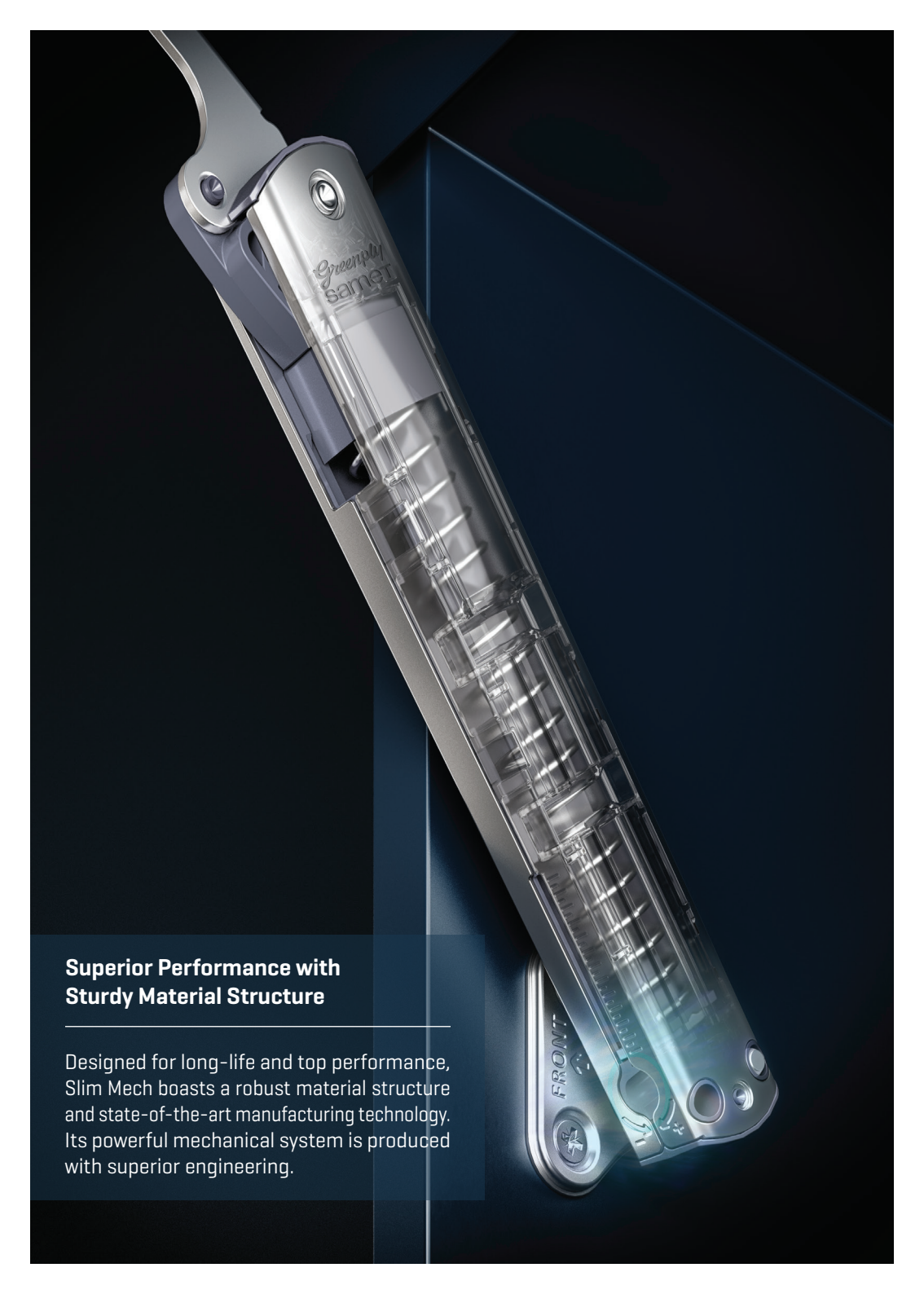

## Superior Performance with Sturdy Material Structure

Designed for long-life and top performance, Slim Mech boasts a robust material structure and state-of-the-art manufacturing technology. Its powerful mechanical system is produced with superior engineering.



## Features

---

- Soft Close and Gradually Opening
- 3D Door Adjustment and Power Adjustment
- Super-Easy User Friendly Assembly
- 4 Different Power Units as A1,B1,C1,D1
- Cabinet Height Between 250 -600 mm
- Cabinet Width up to 1.200 mm

## Package Included

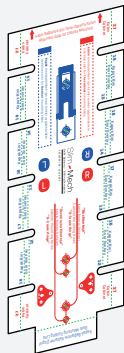

Drilling Template



Door Bracket



Cabinet Bracket

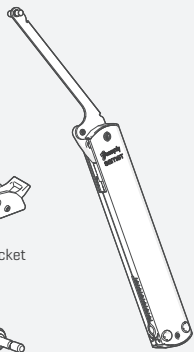

Power Mechanism

## Recommended Products

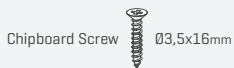

Chipboard Screw  
Ø3,5x16mm

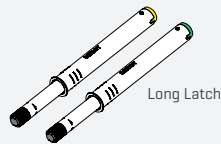

Long Latch



Master Mounting Plate [All Types]

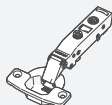

Master Soft-Close Hinge

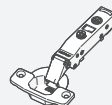

Master Self-Close Hinge

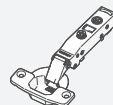

Master Free-Swing Hinge

### Full Overlay ("0 mm" Crank)

Mounting Plate Height	5 mm	7 mm	9 mm
Hd	164	166	168
Xd		37	
Kd		132	
Sd		18+B	

### Half Overlay ("9 mm" Crank)

Mounting Plate Height	5 mm	7 mm	9 mm
Hy	173	175	177
Xy		37	
Ky		132	
Sy		18+B	

### Inset ("18 mm" Crank)

Mounting Plate Height	5 mm	7 mm	9 mm
Hs	182	184	186
Xs		37+K	
Ks		132-P	
Ss		18-B	

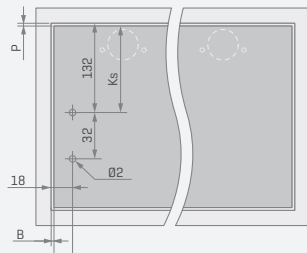
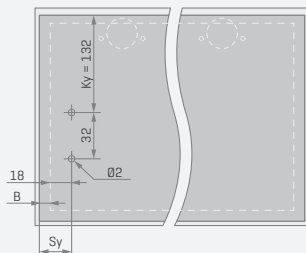
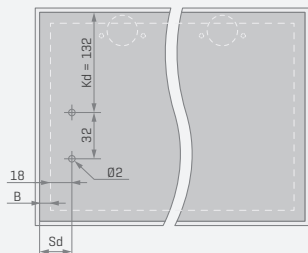
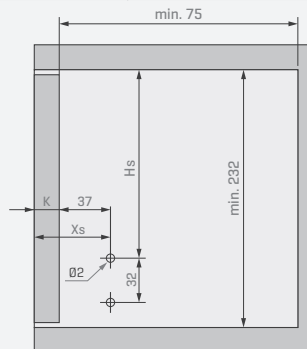
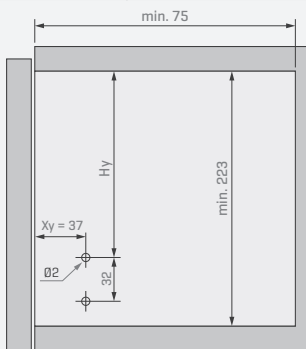
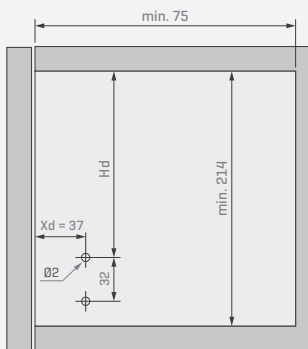

# Slim Mech | CABINET DRILLING TEMPLATE

**1** Fold the cabinet fold lines on the left to use the mechanism on the left cabinet side, and fold the cabinet fold lines on the right to use the mechanism on the right cabinet side, as shown.

**2** Lean the alignment edge for cabinet.

**3** Depending on the hinge type mark the required two holes and drill with Ø2mm drill bit.

Drilling template is convenient for "0 - Crank Hinge" and "9 - Crank Hinge" applications using "5 mm Mounting Plate."

"0-Crank Hinge" Cabinet Mounting Holes

"9-Crank Hinge" Cabinet Mounting Holes

Left Mounting

Right Mounting

# Slim Mech | DOOR DRILLING TEMPLATE

**1** Fold the "Door Mounting folding line" as shown.

**2** Fold the "Door Overlay folding line" as shown according appropriate overlay dimension.

**3** Align the folded areas to the door edges as shown.

**4** Mark the required two holes and drill with Ø2mm drill bit.

Fold the left "Door overlay" folding lines to use on the left door side, and fold the right "Door overlay" folding lines to use on the right door side, and align on the door edge as shown.

Right Mounting

Left Mounting

# Slim Mech | ASSEMBLY INSTRUCTIONS

**2**

**3**

Mounting Hole for Soft-Close

Mounting Hole for Push-Open

**5**

Click

Click

Click

Click

For the Push-Open door application, mount the "Long Latch" part at the specified location as shown.

Ø10 min 80

## POWER ADJUSTMENT

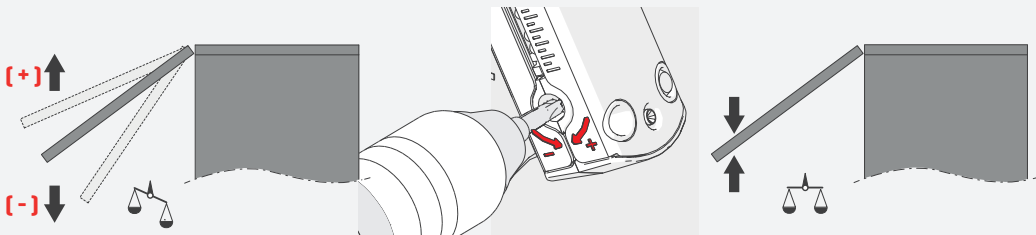

If the door in the open position is lifted and not fixed, turn in direction [-] and if it goes down, then turn in the direction [+] to adjust the balance.

## DOOR ADJUSTMENT

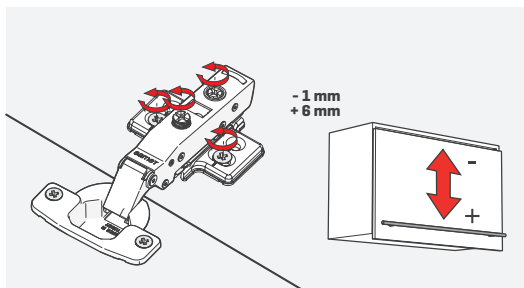
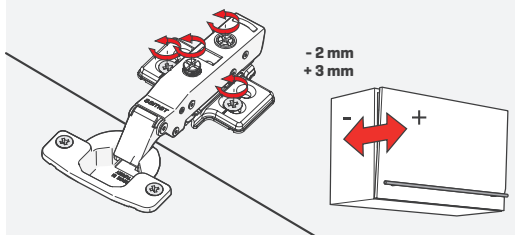
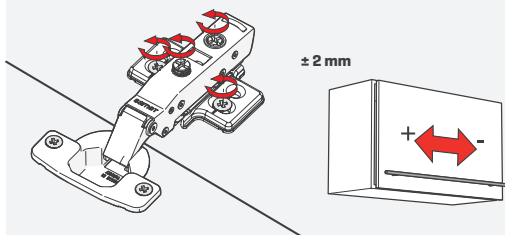

## CAUTION

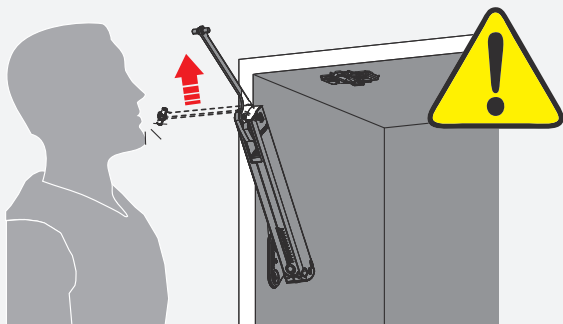



SLIM MECH SOFT-CLOSE	[Master Soft-Close x1] + [Master Self-Close x1]				Master Soft-Close x2			
	A		B		C		D	
	min kg	max kg	min kg	max kg	min kg	max kg	min kg	max kg
250-260	1	1,81	1,81	3,08	3,08	5,2	5,2	6,92
261-270	0,97	1,76	1,76	2,97	2,97	5	5	6,67
271-280	0,93	1,67	1,67	2,79	2,79	4,82	4,82	6,43
281-290	0,89	1,59	1,59	2,69	2,69	4,63	4,63	6,21
291-300	0,86	1,5	1,5	2,6	2,6	4,46	4,46	6
301-310	0,84	1,46	1,46	2,52	2,52	4,32	4,32	5,81
311-320	0,81	1,43	1,43	2,44	2,44	4,19	4,19	5,63
321-330	0,78	1,4	1,4	2,37	2,37	4,05	4,05	5,46
331-340	0,76	1,37	1,37	2,3	2,3	3,92	3,92	5,3
341-350	0,74	1,33	1,33	2,21	2,21	3,8	3,8	5,14
351-360	0,72	1,28	1,28	2,15	2,15	3,67	3,67	5
361-370	0,7	1,23	1,23	2,09	2,09	3,54	3,54	4,87
371-380	0,68	1,2	1,2	2,03	2,03	3,42	3,42	4,74
381-390	0,66	1,17	1,17	1,98	1,98	3,33	3,33	4,62
391-400	0,64	1,15	1,15	1,93	1,93	3,25	3,25	4,5
401-410	0,63	1,11	1,11	1,88	1,88	3,12	3,12	4,39
411-420	0,61	1,08	1,08	1,84	1,84	3,05	3,05	4,29
421-430	0,6	1,05	1,05	1,79	1,79	2,97	2,97	4,19
431-440	0,58	1,03	1,03	1,75	1,75	2,9	2,9	4,09
441-450	0,57	1	1	1,71	1,71	2,83	2,83	4
451-460	0,56	0,99	0,99	1,67	1,67	2,76	2,76	3,91
461-470	0,54	0,97	0,97	1,64	1,64	2,71	2,71	3,83
471-480	0,53	0,95	0,95	1,6	1,6	2,65	2,65	3,75
481-490	0,52	0,93	0,93	1,57	1,57	2,59	2,59	3,67
491-500	0,51	0,92	0,92	1,52	1,52	2,54	2,54	3,6
501-510	0,5	0,89	0,89	1,49	1,49	2,49	2,49	3,53
511-520	0,49	0,87	0,87	1,46	1,46	2,44	2,44	3,46
521-530	0,48	0,84	0,84	1,42	1,42	2,4	2,4	3,4
531-540	0,47	0,83	0,83	1,39	1,39	2,35	2,35	3,33
541-550	0,46	0,81	0,81	1,37	1,37	2,31	2,31	3,27
551-560	0,46	0,8	0,8	1,34	1,34	2,26	2,26	3,22
561-570	0,45	0,79	0,79	1,32	1,32	2,22	2,22	3,16
571-580	0,44	0,77	0,77	1,3	1,3	2,17	2,17	3,1
581-590	0,43	0,76	0,76	1,27	1,27	2,14	2,14	3,05
591-600	0,43	0,75	0,75	1,25	1,25	2,09	2,09	3

Less powerful mechanism is recommended for intersection areas.

If using the double-sided mechanism, the weight capacity is doubled.

\*The door weights above includes door and handle together.

SLIM MECH PUSH-OPEN	[Master Self-Close x1] + [Master Free-Swing x1]								Push-Open Type
	A		B		C		D		
Door Height	min kg	max kg	min kg	max kg	min kg	max kg	min kg	max kg	
250-260	0,8	1,74	1,74	2,84	2,84	4,79	4,79	6,92	Yellow Push Open With Bumber (Code:10299964)
261-270	0,77	1,67	1,67	2,74	2,74	4,61	4,61	6,67	
271-280	0,74	1,59	1,59	2,62	2,62	4,41	4,41	6,43	
281-290	0,71	1,53	1,53	2,5	2,5	4,25	4,25	6,2	
291-300	0,69	1,47	1,47	2,4	2,4	4,1	4,1	6	
301-310	0,67	1,42	1,42	2,32	2,32	3,96	3,96	5,8	
311-320	0,65	1,38	1,38	2,25	2,25	3,83	3,83	5,62	
321-330	0,63	1,34	1,34	2,18	2,18	3,68	3,68	5,45	
331-340	0,6	1,3	1,3	2,12	2,12	3,55	3,55	5,29	
341-350	0,59	1,26	1,26	2,06	2,06	3,43	3,43	5,14	
351-360	0,57	1,21	1,21	1,99	1,99	3,33	3,33	5	
361-370	0,55	1,17	1,17	1,92	1,92	3,24	3,24	4,86	
371-380	0,54	1,13	1,13	1,86	1,86	3,12	3,12	4,73	
381-390	0,53	1,1	1,1	1,81	1,81	3,03	3,03	4,61	
391-400	0,51	1,08	1,08	1,76	1,76	2,94	2,94	4,5	
401-410	0,5	1,05	1,05	1,72	1,72	2,87	2,87	4,39	
411-420	0,49	1,03	1,03	1,68	1,68	2,8	2,8	4,29	
421-430	0,48	1	1	1,64	1,64	2,73	2,73	4,19	
431-440	0,46	0,98	0,98	1,6	1,6	2,67	2,67	4,09	
441-450	0,45	0,96	0,96	1,57	1,57	2,61	2,61	4	
451-460	0,44	0,94	0,94	1,53	1,53	2,55	2,55	3,91	
461-470	0,43	0,92	0,92	1,5	1,5	2,5	2,5	3,83	
471-480	0,42	0,9	0,9	1,47	1,47	2,44	2,44	3,75	
481-490	0,42	0,88	0,88	1,44	1,44	2,39	2,39	3,67	
491-500	0,41	0,86	0,86	1,41	1,41	2,35	2,35	3,6	
501-510	0,4	0,84	0,84	1,38	1,38	2,28	2,28	3,53	
511-520	0,39	0,83	0,83	1,35	1,35	2,22	2,22	3,46	
521-530	0,38	0,81	0,81	1,32	1,32	2,17	2,17	3,4	
531-540	0,38	0,8	0,8	1,3	1,3	2,13	2,13	3,33	
541-550	0,37	0,78	0,78	1,27	1,27	2,09	2,09	3,27	
551-560	0,36	0,77	0,77	1,25	1,25	2,05	2,05	3,21	
561-570	0,36	0,76	0,76	1,23	1,23	2,01	2,01	3,16	
571-580	0,35	0,74	0,74	1,21	1,21	1,98	1,98	3,1	
581-590	0,34	0,73	0,73	1,19	1,19	1,95	1,95	3,05	
591-600	0,34	0,72	0,72	1,17	1,17	1,92	1,92	3	

Yellow Push Open With Bumber (Code:10299964)

Green Push Open With Bumber (Code:10299963)





Less powerful mechanism is recommended for intersection areas.

If using the double-sided mechanism, the weight capacity is doubled.

Code	Description	Power	Package	Quantity [pc]
12427630008084	Slim Mech Retail Package	A1	Retail	2
12427730008084	Slim Mech Retail Package	B1	Retail	2
12427830008084	Slim Mech Retail Package	C1	Retail	2
12427430008084	Slim Mech Retail Package	D1	Retail	2



[www.greenplysamet.com](http://www.greenplysamet.com)

-  Greenply-Samet
-  GreenplySamet
-  GreenplySamet
-  GreenplySamet
-  GreenplySamet