

DOOR HANDLES
LOCKS & SECURITY SYSTEMS
DOOR CONTROL SYSTEMS
ACCESSORIES
PATCH FITTINGS
DIGITAL DOOR LOCK

dorsët
we understand



Our Business

We are Dorset, an ISO 9001:2015, EMS 14001 : 2015, BS OHSAS 45001 : 2018 organization with over 25 Years of experience as a reputed manufacturer of architectural hardware and provider of high security locking solutions.

We combine new age aesthetics with cutting edge technology. The result is a range of path-breaking products that redefine functionality, reliability and durability.

Our collection includes door handles, door locks, lock accessories, security systems, door control devices, glass hardware, door accessories and electronic safes covering all sectors including homes, offices, establishments and industrial facilities.

Besides adding new segments to our existing range we are in the process of expanding our international presence and further enhancing our quality standards by equipping ourselves with the powers of Automation, Emerging Technologies backed by a full-fledged research unit

comprising four independent R & D cells dedicated to ushering in tomorrow, today.

At the heart of it all is our understanding of the evolving technological scenario and changing consumer needs.

We understand that in order to stay ahead we have to keep innovating to keep delighting our customers.

We have some of the best brains in the industry comprising of people who are techno - commercial having a sense of business & acumen to understand the customer needs and aspirations.

VISION

To be an enterprising, innovative and profitable global supplier of total access products for homes and workspaces, and to be an employer who understands the importance of creating value for all stakeholders.

MISSION

"Dorset Inside" We shall strive to create innovative, value-based and trustworthy products for all establishments to ensure a safe and secure living and working environment



Corporate Office: Gurugram



Manufacturing Plant: Gurugram



Product Overview



Abitare Series



Farretto Series



Premium Series



Stainless Steel Series

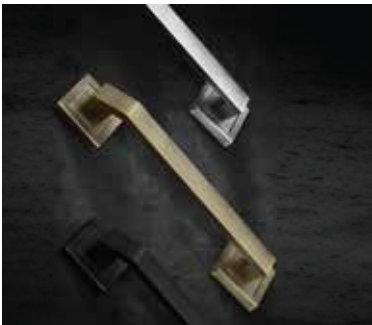

Pull Handle



Combo Lockset Series



Mortise Lock



Euro Profile Cylinder



Door Closer



Phantom Rim Lock



Furniture Lock



Floor Spring



Hinges & Tower Bolt



Glass Solution



Digital Door Lock



Furniture & Kitchen Fitting

dorsët
we understand

THE APP
IS HERE TO
MAKE YOUR
LIFE EASIER...



SCAN TO DOWNLOAD
THE APP

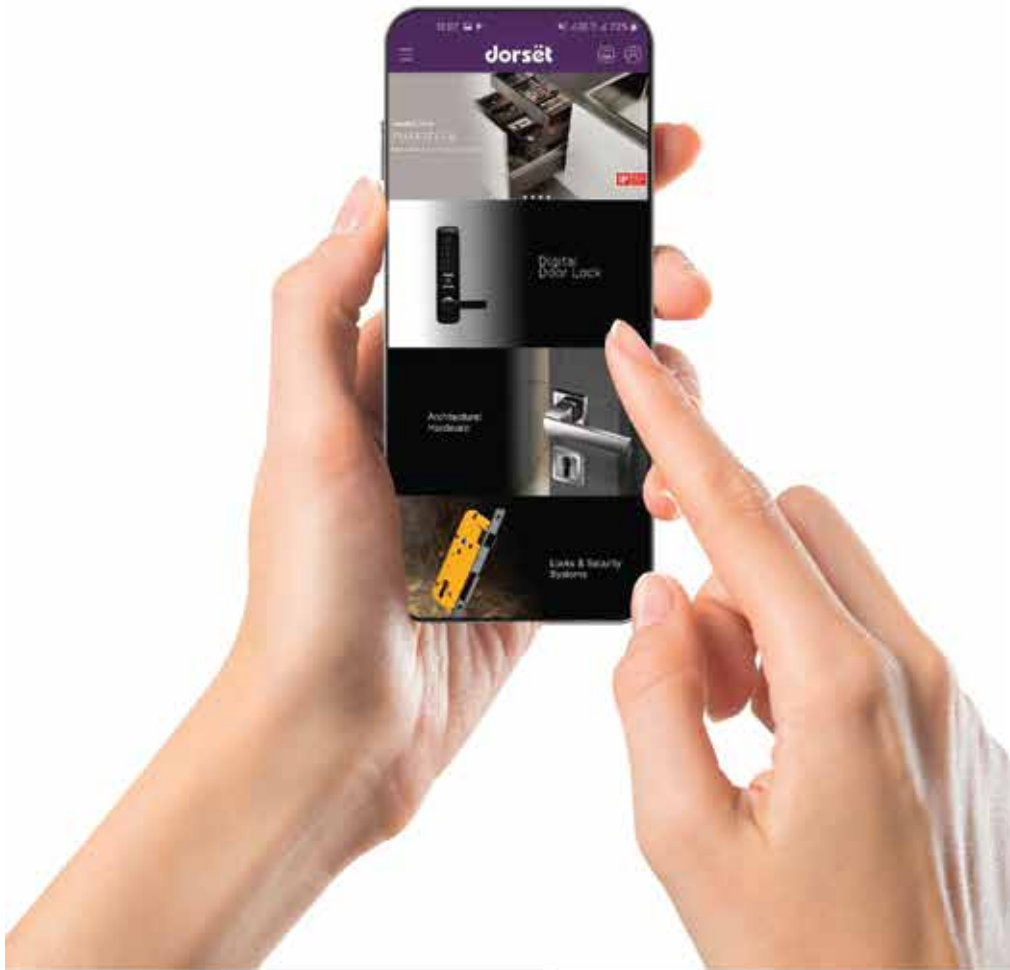

ADVANCED FEATURES



Latest Product Brochure
and Price List



Product Installation
Videos



New Collection
Launches



Get Instant
Quotation



Latest Offers



Service Enquiry
Complaints



Where To Buy



Make Your Own
Project



GET IT ON
Google Play

Download on the
App Store

www.dorsetindia.com



















Follow us on [f](#) [in](#) [v](#) [i](#)



















INDEX











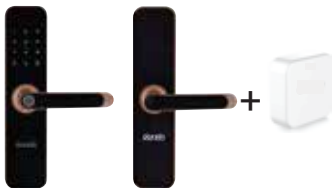





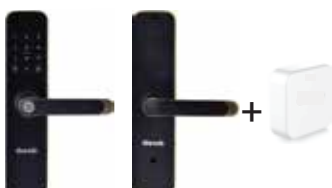



1. DIGITAL LOCKS01
DIGITAL DOOR LOCK01
DIGITAL FURNITURE LOCK08
2. FIRE RATED PRODUCTS10
2. DOOR HANDLES12
ABITARE HANDLES12
FARRETTO SERIES13
PREMIUM HANDLES15
STAINLESS STEEL HANDLES17
PREMIUM PULL HANDLES19
STAINLESS STEEL PULL HANDLES21
3. LOCKS & SECURITY SYSTEMS22
MORTISE LOCK22
EURO PROFILE CYLINDER24
PHANTOM & PHANTOM FARRETTO27
KNOB SET29
FURNITURE LOCK29
COMBO LOCK SET30
4. DOOR CONTROL SYSTEMS47
5. HINGES & TOWER BOLT49
6. ACCESSORIES50
7. STRAIGHT PATCH FITTING51





dorsët



Model	Variant	Code	Description	MRP
		DG 201 IRG	Digital Lock Mortise DG 201 IRG 4-in-1 Access (Bio + Pin + Key+ Card)	19405/-
		DG 201 MRG	Digital Lock Mortise DG 201 MRG 4-in-1 Access (Bio + Pin + Key+ Card)	21170/-
		DG 201 IPT	Digital Lock Mortise DG 201 IPT 4-in-1 Access (Bio + Pin + Key+ Card)	19405/-
		DG 201 MPT	Digital Lock Mortise DG 201 MPT 4-in-1 Access (Bio + Pin + Key+ Card)	21170/-
		DG 201 IGM	Digital Lock Mortise DG 201 IGM 4-in-1 Access (Bio + Pin + Key+ Card)	18520/-
		DG 201 MGM	Digital Lock Mortise DG 201 MGM 4-in-1 Access (Bio + Pin + Key+ Card)	19845/-
		DG 202 IGM	Digital Lock Mortise DG 202 IGM 5-in-1 Access (Bio + Pin + Key+ Card) with WiFi In Built	20615/-
		DG 202 MGM	Digital Lock Mortise DG 202 MGM 5-in-1 Access (Bio + Pin + Key+ Card) with WiFi In Built	21720/-
		DG 202 ISN	Digital Lock Mortise DG 202 ISN 5-in-1 Access (Bio + Pin + Key+ Card) with WiFi In Built	22040/-









Model	Variant	Code	Description	MRP
		DG 202 MSN	Digital Lock Mortise DG 202 MSN 5-in-1 Access (Bio+Pin + Card+ Key) with WiFi In Built	23140/-
		DG 203 IRG	Digital Lock Mortise DG 203 IRG 5-in-1 Access (Bio+Pin + Card+ Key) with BLE In Built	20935/-
		DG 203 MRG	Digital Lock Mortise DG 203 MRG 5-in-1 Access (Bio+Pin+Card+Key) with BLE In built	22155/-
		DG 203 IGM	Digital Lock Mortise DG 203 IGM 5-in-1 Access (Bio+Pin+Card+Key) with BLE In built	19625/-
		DG 203 MGM	Digital Lock Mortise DG 203 MGM 5-in-1 Access (Bio+Pin+Card+Key) with BLE In built	20725/-
		DG 203 MPT	Digital Lock Mortise DG 203 MPT 5-in-1 Access (Bio+Pin+Card+Key) with BLE In built	22155/-
		DG 204 MRG	Digital Lock Mortise DG 204 MRG 5-in-1 Access (Bio+Pin+Card+Key) With Wifi In built & integrated Camera	29610/-
		DG 204 MGM	Digital Lock Mortise DG 204 MGM 5-in-1 Access (Bio+Pin+Card+Key) With Wifi In built & integrated Camera	28035/-
		DG 203 IRG Combo	Digital Lock Mortise DG 203 IRG Combo 5-in-1 Access (Bio+Pin + Card+ Key) with BLE In built & Wifi Gateway Module	23915/-









Model	Variant	Code	Description	MRP
		DG 203 MRG Combo	Digital Lock Mortise DG 203 MRG Combo 5-in-1 Access (Bio+Pin + Card+ Key) with BLE In built & Wifi Gateway Module	25130/-
		DG 203 IGM Combo	Digital Lock Mortise DG 203 IGM Combo 5-in-1 Access (Bio+Pin + Card+ Key) with BLE In built & Wifi Gateway Module	22600/-
		DG 203 MGM Combo	Digital Lock Mortise DG 203 MGM Combo 5-in-1 Access (Bio+Pin + Card+ Key) with BLE In built & Wifi Gateway Module	23705/-
		DG 203 MPT Combo	Digital Lock Mortise DG 203 MPT Combo 5-in-1 Access (Bio+Pin + Card+ Key) with BLE In built & Wifi Gateway Module	25130/-
		DG 401 IRG	Digital Pull Lock DG 401 IRG 4-in-1 Access (Bio + Pin + Key+ Card) BLE -Optional	45675/-
 		DG 801 MGM	Digital Lock BLE DG 801 MGM WITH CLOUD KEY 5-in-1 Access (Bio+Pin + Card+ Key) with BL & Cloud Key	49510/-
 		DG 801 IGM	Digital Lock BLE DG 801 IGM WITH CLOUD KEY 5-in-1 Access (Bio+Pin + Card+ Key) with BL & Cloud Key	47250/-
		DG 501 MGM	Digital Lock Mortise DG 501 MGM 4-in-1 Access (Bio + Pin + Key+ Card) BLE -Optional	40425/-
		DG 501 IGM	Digital Lock Mortise DG 501 IGM 4-in-1 Access (Bio + Pin + Key+ Card) BLE -Optional	38155/-











Model	Variant	Code	Description	MRP
		DG 503 MGM	Digital Lock Mortise DG 503 MGM 3-in-1 Access (Bio + Pin + Key) BLE -Optional	36750/-
		DG 503 IGM	Digital Lock Mortise DG 503 IGM 3-in-1 Access (Bio + Pin + Key) BLE -Optional	34545/-
		DG 503 MRG	Digital Lock Mortise DG 503 MRG 3-in-1 Access (Bio + Pin + Key) BLE -Optional	37800/-
		DG 503 IRG	Digital Lock Mortise DG 503 IRG 3-in-1 Access (Bio + Pin + Key) BLE -Optional	35595/-
		DG 502 MGM	Digital Lock Mortise DG 502 MGM 3-in-1 Access (Pin + Card+ Key) BLE -Optional	27825/-
		DG 502 IGM	Digital Lock Mortise DG 502 IGM 3-in-1 Access (Pin + Card+ Key) BLE -Optional	25620/-
		DG 502 MRG	Digital Lock Mortise DG 502 MRG 3-in-1 Access (Pin + Card+ Key) BLE -Optional	28875/-
		DG 502 IRG	Digital Lock Mortise DG 502 IRG 3-in-1 Access (Pin + Card+ Key) BLE -Optional	26670/-
		DG 504 MGM	Digital Lock Mortise DG 504 MGM 2-in-1 Access (Pin + Key) BLE -Optional	23625/-

Model	Variant	Code	Description	MRP
		DG 504 IGM	Digital Lock Mortise DG 504 IGM 2-in-1 Access (Pin + Key) BLE -Optional	21420/-
		DG 504 MRG	Digital Lock Mortise DG 504 MRG 2-in-1 Access (Pin + Key) BLE -Optional	24675/-
		DG 504 IRG	Digital Lock Mortise DG 504 IRG 2-in-1 Access (Pin + Key) BLE -Optional	22470/-
		DG 101 MGM	Digital Lock Mortise DG 101 MGM 4-in-1 Access (Bio+Pin+Card+Key)	18185/-
		DG 101 GM	Digital Lock Mortise DG 101 GM 4-in-1 Access (Bio+Pin+Card+Key)	16780/-
	Rim	DG 806 GM	Digital Lock RIM DG 806 GM 2-in-1 Access (Pin + Card)	10695/-
	Rim	DG 906 GM	Digital Lock RIM DG 906 GM 2-in-1 Access (Pin + Card) Verti Lock Body Suitable for Narrow Stile	11575/-
	Rim	DG 906 SL	Digital Lock RIM DG 906 SL 2-in-1 Access (Pin + Card) Suitable for Sliding Door	13120/-
	Rim	DG 807 GM	Digital Lock RIM DG 807 GM 1-in-1 Access (Pin)	9020/-

Model	Variant	Code	Description	MRP
	Rim	DG 907 GM	Digital Lock RIM DG 907 GM 1-in-1 Access (Pin) Verti Lock body Suitable for Narrow Stile	9590/-
	Rim	DG 601 GM	Digital Lock RIM DG 601 GM 4-in-1 Access (Bio + Pin + Key+ Card)	31500/-
	Rim	DG 603 GM	Digital Lock RIM DG 603 GM 3-in-1 Access (Bio + Pin + Key)	27300/-
 	Glass Rim	DG 705 GM	Digital Lock Glass DG 705 GM 3-in-1 Access (Bio+Card+ Pin)	31290/-
 	Glass Rim	DG 705 GM(R)	Digital Lock Glass DG 705 GM With RX 3-in-1 Access with remote (Bio+Card+ Pin)	39900/-

	Model	Code	Description	MRP
Digital Furniture/Cabinet/Wardrobe Lock		DG 303/ DG 303 FG	Biometric Lock (Up to 20 Unique Access)	4380/- 4370/-
		DG 303 SL	Biometric Lock (Up to 20 Unique Access)	4570/-
		DG 304	Biometric Lock (Up to 40 Unique Access)	3125/-
		DG 304 SL	Biometric Lock (Up to 40 Unique Access)	3175/-
		DG 305	Biometric Lock (Up to 40 Unique Access)	4790/-
		DG 306	asword 4 to 15 Digits & Mechanical Key	2190/-
		DG 307	Biometric Lock (Up to 20 Unique Access)	5000/-
		DG 308 FG	Biometric Lock (Up to 20 Unique Access)	4590/-

Accessories	Name	Code	Description	MRP
	BLE Kit for DG 500 Series & DG 401	BLE DG 50	It includes BLE Module	4200/-
	Wifi Kit for DG 200 Series	DG20WIFI	It includes Wifi Gateway Module	5250/-
	Remote Kit for DG 500 Series	RE DG 50 NEW	It includes Rx Module and Remote	9200/-
	Remote Kit for DG 600 Series	RE DG 601/603	It includes Rx Module and Remote	9200/-
	Remote Kit for DG 600 Series	RE DG 606/607	It includes Rx Module and Remote	9200/-
	Remote Kit for DG 806/807	RE DG 806/807	It includes Rx Module and Remote	9200/-
	Remote Kit for DG 906/907	RE DG 906/907	It includes Rx Module and Remote	9200/-
	Video Door Phone Module for 200 Series	VDP DG 200	It include Rx & Tx for configuring Video Door Phone	9649/-

Accessories	Name	Code	Description	MRP
	Video Door Phone Module for 500 Series	VDP DG 50 NEW	It include Rx & Tx for configuring Video Door Phone	9650/-
	Video Door Phone Module for 601/603	VDP 601/603	It include Rx & Tx for configuring Video Door Phone	9650/-
	Video Door Phone Module for 606/607	VDP 606/607	It include Rx & Tx for configuring Video Door Phone	9650/-
	Video Door Phone Module for 806/807	VDP 806/807	It include Rx & Tx for configuring Video Door Phone	9650/-
	Video Door Phone Module for 801	VDP DG 801	It include Rx & Tx for configuring Video Door Phone	9650/-
	RFID Card	DG CARD	Dorset branded RFID card	400/-
	RFID Tag	DG TAG	RFID Tag	400/-
	RFID Sticker	DG STCR	Smart RFID Sticker	300/-
	Glass Double Door Striker Plate	DG DDA	Glass Double Door Striker Plate	4300/-
	Extended Warranty Card	EWC DG	1 Year Extended warranty Card	2400/-

Stainless Steel Pull Handles (SS Grade-304)		Finish Available			
		SS			
Primo (Pair)	 Size 180mm 230mm 282mm 330mm Fire Rated Upto 2 Hours	PR 06 P SS	PR 08 P SS	PR 10 P SS	PR 12 P SS
		2040	2165	2355	2545
Eden (Pair)	 Size 184mm 234mm 286mm 334mm Fire Rated Upto 2 Hours	ED 06 P SS	ED 08 P SS	ED 10 P SS	ED 12 P SS
		1470	1620	1740	1905

Stainless Steel Pull Handles (SS Grade-304)		19mm dia	22mm dia		
		SS	SS		
D Type (Pair)	 Fire Rated Upto 2 Hours	SD06PSS	SD06PSS		
		1385	1470		
		SD08PSS	SD08PSS		
		1545	1620		
		SD10PSS	SD10PSS		
		1670	1755		
		SD12PSS	SD12PSS		
		1830	1905		
		25.4mm dia		32mm dia	
		SS		SS	
		400mm	SD16PSS	600mm	SD24PSS
			2910		4050
		450mm	SD18PSS	750mm	SD30PSS
			3130		4860
500mm	SD20PSS	900mm	SD36PSS		
	3360		5655		
600mm		1200mm	SD48PSS		
			7380		

Stainless Steel Pull Handles (SS Grade-304)		22mm dia
		SS
SEP Type (Pair)	 Fire Rated Upto 2 Hours	SEP 08 PSS
		1620
		SEP 10 PSS
		1790
		SEP 12 PSS
		1960



Stainless Steel Pull Handles (SS Grade-304)		22mm dia	25.4mm dia	32mm dia
		SS	SS	SS
H Type (Pair)	 Fire Rated Upto 2 Hours	SH 08 P SS		
		2165		
		SH 10 P SS		
		2370		
		SH 12 P SS		
		2545		
			SH 14 P SS	
			3115	
			SH 16 P SS	
			3360	
			SH 18 P SS	
			3595	
		SH 24 P SS		
		4830		
		SH 30 P SS		
		5525		
		SH 36 P SS		
		6230		
		SH 48 P SS		
		7635		

Mortise Lock					
			Description	Finish Available	Std. Pkg.
			SS		
ML 100	 Fire Rated Upto 2 Hours		Mortise Sash Lock-Fire Rated 50mm Backset	ML 100 SS (FR)	1895 20
			Mortise Sash Lock-Fire Rated 55mm Backset	ML 101 SS (FR)	
ML 100L	 Fire Rated Upto 2 Hours		Mortise Latch Lock-Fire Rated 50mm Backset	ML 100L SS (FR)	1700 20
			Mortise Latch Lock-Fire Rated 55mm Backset	ML 101L SS (FR)	
ML 100D	 Fire Rated Upto 2 Hours		Mortise Dead Lock-Fire Rated 50mm Backset	ML 100D SS (FR)	1700 20
			Mortise Dead Lock-Fire Rated 55mm Backset	ML 101D SS (FR)	

Mortise Lock					
	Description	Finish Available		Std. Pkg.	Fire Rated
		SS			
ML 103L	 NEW Mortise Sash Lock-Fire Rated 55mm Backset	ML 103L SS (FR)	1480	20	Fire Rated Upto 2 Hours
ML 103D	 NEW Mortise Sash Lock-Fire Rated 55mm Backset	ML 103D SS (FR)	1480	20	Fire Rated Upto 2 Hours

SS Grade 304		Size	Code	Finish	Std. Pkg.
				SS	
		127 X 76 X 2.5MM	HGRC1152 A	590	40
		102 X 76 X 3MM	HGRC1153 A	550	40

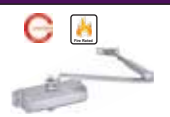
Fire Rated Upto 2 Hours

Door Closers		Description	Weight	Finish	Std. Pkg.
				SS	
FR 60		Door Closer	60 Kg	2555	10
FR 80		Door Closer	80 Kg	3220	10
FR 120		Door Closer	120 Kg	6380	10

Fire Rated Upto 2 Hours

SS Grade 304		Size	Code	Finish	Std. Pkg.
				SS	
		102 X 76 X 2.5MM	HG 1151 A	355	40
		127 X 76 X 2.5MM	HG 1152 A	390	40
		102 X 76 X 3MM	HG 1153 A	400	40
		127 X 76 X 3MM	HG 1154 A	480	40

Fire Rated Upto 2 Hours

For Steel Door		Size	Code	Finish	Std. Pkg.
				SS	
		102x76x3mm	HG 1253	620	40

Fire Rated Upto 2 Hours







ML 100 FR



DOOR CLOSER



TWO BALL BEARING HINGES



PIN TYPE HINGES



ML 100 L FR























PULL HANDLE



abitare
Door Handles

ABITARE SERIES - DESIGNED IN ITALY
(BRASS)

	Finish Available				
	PT	SN/TM	FE/HG	TM/MR	GM/VG
Leva	 LEV OR PT	 LEV OR SN	 LEV OR FE	 LEV OR TM	
	4675	4905	5375	4950	
Torso	 TOR OR PT	 TOR OR SN/TM	 TOR OR FE	 TOR OR MR	 TOR OR VG
	4440	4910	5400	4675	5140
Globo	 GLO OR PT	 GLO OR SN	 GLO OR FE		 GLO OR GM
	4440	5155	5645		5200
Twirl	 TWR OR PT	 TWR OR SN	 TWR OR HG	 TWR OR TM	
	4440	5155	5645	5155	
Deco	 DEC OR PT	 DEC OR SN		 DEC OR TM	
	4440	5155		5155	







**INDIA
DESIGN
MARK**

GOOD
DESIGN











Farrëtto <i>Colours</i> (Brass) Door Handles		Finish Available			
		FETM	GMHG	HGGM	TMHG
Juliet		JL OR FETM	JL OR GMHG	JL OR HGGM	JL OR TMHG
		4830	4445	4830	4445

Farrëtto <i>Colours</i> (Brass) Door Handles		Finish Available				
		SN	HG/FG	FE/GM	GM/MR/CB	TM/VG
Cadilla			CAD OR HG	CAD OR GM	CAD OR CB/MR	CAD OR VG
			4620	4145	4090	4620
Roccia			ROC OR HG		ROC OR GM/MR/CB	ROC OR VG
			5840		5155	5840
Madonna		MA OR SN	MA OR HG			MA OR TM
		4305	4975			4305
Blob			BB OR HG	BB OR FE	BB OR GM	
			5435	5435	5435	
Dana		DA OR SN	DA OR HG	DA OR FE		
		4045	4445	4445		
Vanya		VNY OR SN	VNY OR FG	VNY OR FE	VNY OR GM	
		4800	5400	5400	4800	
Anika		ANK OR SN	ANK OR FG/HG			ANK OR TM
		4700	5400			4700

Farrëtto <i>Colours</i> Door Handles		Finish Available			
Riva		RIV OR SN	RIV OR HG	RIV OR MR/CB	RIV OR NM
		3190	3615	3190	3615
Konica			KON OR FEGM	KON OR HGFE	
			4680	4820	
Speera		SPE OR GMHG	SPE OR FEWD	SPE OR HGFE	SPE OR TMWD
		3875	3875	4150	3615
Orbia			OBI OR BNGM	OBI OR HGFE	
			4750	5020	
Cornus			COR OR BNGM	COR OR HGFE	
			4880	5155	

Farrëtto <i>Colours</i> Door Handles		Finish Available			
Pilot		PIL OR GMHG	PIL OR FEGM	PIL OR HGFE	PIL OR SNTM
		4820	4820	5085	4275
Infinito		INF OR GMHG	INF OR FEGM	INF OR HGFE	
		4425	4680	4955	
Trase		TRA OR GMHG/TMHG	TRA OR FEGM/VGGM	TRA OR HGFE	TRA OR CBMR
		4550	4680	4955	4550
Flo		FLL OR GMHG	FLL OR FEWD	FLL OR TMSN/MR	FLL OR NM
		4150	4820	4020	4820

Farrëtto <i>Colours</i> Door Handles		Finish Available				
		SN/TM	GM/CT/FM	HG/FE/VG	CB/MR	NM
Polar		POL OR SN/TM		POL OR HG	POL OR CB	POL OR NM
		3285		3825	3285	3935
Ryder		RYD OR TM		RYD OR FE	RYD OR CB/MR	
		3615		4150	3615	
Flap		FLA OR TM		FLA OR FE		
		4020		4955		
Celisa		CLS OR SN/TM	CLS OR GM/FM	CLS OR HG/FE/VG		CLS OR NM
		4020	4215	4915		5020
Drop		DRP OR SN/TM	DRP OR CT/FM	DRP OR HG/FE	DRP OR CB/MR	
		3615	3720	4275	3615	
Reflex		REF OR SN/TM		REF OR HG/FE		
		3615		4275		
Volex		VOE OR SN/TM	VOE OR GM/CT/FM			
		3020	3145			
Vitra		VIT OR SN/TM	VIT OR GM/CT/FM	VIT OR HG		
		2865	2995	3465		
Atelier		ATL OR SN/TM	ATL OR GM/CT/FM	ATL OR HG/VG		ATL OR NM
		2865	2995	3465		3570



Farretto Collection Door Handles		Finish Available				
		SN/TM	GM/CT/FM	HG/FE/VG	CB/MR	NM
Siera		SIA OR SN/TM	SIA OR GM/CT/FM	SIA OR HG		
		3020	3145	3620		
Argus		ARG OR SN/TM	ARG OR GM/CT/FM	ARG OR HG		
		3450	3550	4035		
Krysta		KRY OR SN/TM	KRY OR GM/CT/FM			
		2865	2995			











Farretto Collection Door Handles		Finish Available						
		SN/CB	GM/TC	TM	CT	FM/TB	HG/FE	NM/MR
Optio		OPT OR SN	OPT OR GM	OPT OR TM	OPT OR CT	OPT OR FM	OPT OR HG	
		3020	3145	3020	3145	3145	3620	
Velvet		VLV OR SN/CB	VLV OR TC	VLV OR TM	VLV OR CT	VLV OR TB	VLV OR HG/FE	VLV OR NM
		4345	4565	4345	4565	4565	5310	5420
Morphos		MOR OR CB						MOR OR MR
		4125						4125





Farretto Collection Door Handles		Finish Available		
		CT	SN	GM
Drop		DRP 10 CT	DRP 10 SN	DRP 10 GM
		3850	3850	3850
Velvet		VLV 10 CT	VLV 10 SN	VLV 10 GM
		4690	4485	4690







Farretto Collection Pull Handles		Finish Available		
		SN	TM/GM	HG/FE
Teesta (Pair)		TES12PSN	TES12PTM	TES12PFE
		5725	5725	6505
Teesta(Pair)		TES18PSN	TES18PTM	TES18PFE
		7475	7475	8290











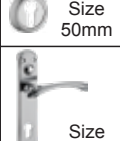

Farretto Collection Pull Handles		Finish Available		
		SN	TM/GM	HG/FE
Teesta (Pcs)		TES12PRSN	TES12PRTM	TES12PRFE
		3130	3130	3620
Teesta (Pcs)		TES18PRSN	TES18PRTM	TES18PRFE
		3930	3930	4480
Tero (Pair)		TRO12PSN	TRO12PGM	TRO12PHG
		5140	5140	6075
Mohana (Pair)		MOH12PSN	MOH12PTM	MOH12PFE
		5550	5550	6465
Forte (Pair)		FRT12PSN	FRT12PGM	FRT12PFE
		4675	4675	5375
Forza (Pair)		FRZ12PSN	FRZ12PTM	FRZ12PHG
		5020	5020	5725
Forza (Pair)		FRZ18PSN	FRZ18PTM	FRZ18PHG
		6425	6425	7355
Forza (Pcs)		FRZ12PRSN	FRZ12PRTM	FRZ12PRHG
		2700	2700	3260
Forza (Pcs)		FRZ18PRSN	FRZ18PRTM	FRZ18PRHG
		3380	3380	3930

Door Handles Lever		Finish Available		
		WD	SS/SC	PT/TM
Riva			RIV OR SS	RIV OR PT
			2980	2980
Konica			KON OR SNSS	KON OR PT
			3565	3565
Speera			SPE OR SNWD	SPE OR PTM
			3180	3180
Polar				POL OR PT
				2895
Ryder			RYD OR SS	RYD OR PT
			3180	3180
Trase		TRA OR SNWD	TRA OR SNSS	TRA OR PTM
		3690	3690	3690
Velvet			VLV OR SS	VLV OR PT
			3950	3950
Velvet			VLV 10 SS	VLV 10 PT
			4070	4070
Orbia		OBI OR SNWD	OBI OR SC	
		4520	4270	
Celisa			CLS OR SS	CLS OR PT
			3565	3565

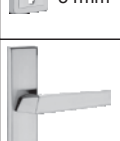
Door Handles Lever		Finish Available		
		WD	SS/SC	PT/TM
Drop			DRP OR SS	DRP OR PT
			3180	3180
Drop			DRP 10 SS	DRP 10 PT
			3320	3320
Terza			TER OR SC	TER OR PT
			3815	3815
Terza			TER 10 SC	TER 10 PT
			4135	4135
Flo			FLL OR SS	FLL OR PT
			3690	3690
Cornus		COR OR SNWD	COR OR SC	COR OR PTM
		4645	4345	4345
Stark			STA OR SS	STA OR PT
			4425	4425
Infinito			INF OR SNSS	INF OR PTM
			3690	3690
Pilot		PIL OR SSWD	PIL OR SNSS	
		3825	3825	
Reflex			REF OR SS	REF OR PT
			3180	3180





Door Handles Lever		Finish Available		
		WD	SS/SC	SN/PT
Edge	 Size 28mm		EDG OR SS	EDG OR PT
			4010	4010
Flap	 Size 28mm			FLA OR SN/PT
				3690
Liberte	 Size 28mm	LIB OR WD	LIB OR SC	
		4395	4270	
Morphos	 Size 54mm		MOR OR SS	MOR OR PT
			3745	3745
Morphos	 Size 240mm		MOR 10 SS	MOR 10 PT
			4000	4000







(Brass) Door Handle Lever		Finish Available	
		SS	PT
Vanya	 NEW		VNY OR PT
			4700
Anika	 NEW		ANK OR PT
			4700
Cadila	 NEW	CAD OR SS	CAD OR PT
		3825	3825
Roccia	 NEW		ROC OR PTTM
			4655
Nika	 Size 50.4mm	NK OR SS	NK OR PT
		3845	3845
Nika	 Size 252mm	NK 10 SS	NK 10 PT
		4125	4125
Madonna	 Size 50.4mm	MA OR SS	MA OR PT
		3935	3935

(Brass) Door Handle Lever		Finish Available	
		SS	PT
Dana	 Size 50.4mm	DA OR SS	DA OR PT
		3355	3355
Dana	 Size 252mm	DA 10 SS	DA 10 PT
		3550	3550
Juliet	 Size 50mm	JL OR SS	JL OR PT
		3935	3935
Juliet	 Size 203mm	JL 10 SS	JL 10 PT
		4155	4155
Zenith	 Size 50mm	ZE OR SS	ZE OR PT
		3935	3935
Zenith	 Size 240mm	ZE 10 SS	ZE 10 PT
		4155	4155
Sana	 Size 54mm	SN OR SS	SN OR PT
		4290	4290
Sana	 Size 231mm	SN 10 SS	SN 10 PT
		4290	4290
Xia	 Size 53mm	XI OR SS	XI OR PT
		4500	4500
Xia	 Size 262mm	XI 10 SS	XI 10 PT
		4500	4500
Blob	 Size 50mm	BB OR SS	BB OR PT
		4535	4535
Petal	 Size 52.3mm	PEA OR ZSC	PEA OR ZPT
		4035	4035

Door Handles Solid Stainless Steel (SS Grade-304)		19mm dia
		SS
Orius		ORS OR SS
		3990
Cella		CLA OR SS
		3745
Merina		MER OR SS
		3300
Axor		AXO OR SS
		3300

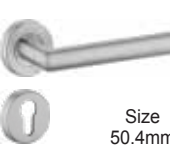
Door Handles Stainless Steel (SS Grade-304)		Finish Available
		SS
Eden	 Size 248mm	ED 10 SS
		2120
Eden	 Size 54mm	ED OR SS
		1790
Primo	 Size 248mm	PR 10 SS
		2270
Primo	 Size 54mm	PR OR SS
		1945

Door Handles Stainless Steel (SS Grade-304)		19mm dia			22mm dia		
		SS	GM	TM	SS	GM	TM
D Type	 Size 50mm	SD OR SS			SD OR SS	SD OR GM	SD OR TM
		1605			1670		
	 Size 50mm						2455
SLP	 Size 50mm					2025	
		SLP OR SS	SLP OR GM	SLP OR TM			
SLP	 Size 50.4mm	1605					
				2150			
	 Size 50.4mm		1905				

Door Handles Stainless Steel (SS Grade-304)		19mm dia	22mm dia
		SS	
Nika (SS)	 Size 50.4mm	NS OR SS	
		3390	
L Type	 Size 50.4mm	SL OR SS	SL OR SS
		1605	1670
C Type	 Size 51mm		SC OR SS
			2080
SO	 Size 50.4mm	SO OR SS	
		1605	
SEP	 Size 50.4mm	SEP OR SS	
		1605	
D Type	 210 X 55 X 2		SD OP SS 2
			2720
D Type	 175 X 175 X 2		SD OP SS 1
			2720











Rose (Stainless Steel)		Description	SS
Handle Rose		Rose (4pcs) Kit for Pull Handle (Available in 19 & 22 mm dia, Stainless Steel)	KT-1701 (19)
			380
Key Rose		Key Rose Pair (Stainless Steel)	KT-1702 (22)
			395
Handle Rose		Rose (4pcs) Kit for Pull Handle (Available in 19 mm dia, Stainless Steel)	KT-1703
			205
Key Rose		Key Rose Pair (Stainless Steel)	KIT-1704
			395
Key Rose		Key Rose Pair (Stainless Steel)	KIT-1705
			210

SAFE TOUCH









Door Handles with Anti-bacterial coating against Bacterial & Microbial Growth.









Antibacterial Coating Available Against Special Order.









Pull Handles	Finish Available	
	SS	PT
Teesta (Pair)  W/O Rose Model	TES12PSS	TES12PPT
	5610	5610
Teesta (Pcs)  On Rose Model	TES12PRSS	TES12PRPT
	3065	3065
Teesta (Pair)  W/O Rose Model	TES18PSS	TES18PPT
	7240	7240
Teesta (Pcs)  On Rose Model	TES18PRSS	TES18PRPT
	3805	3805
Tero (Pair)  W/O Rose Model	TRO12PSS	TRO12PPT
	4965	4965
Mohana (Pair)  W/O Rose Model	MOH12PSS	MOH12PPT
	5435	5435
Forte (Pair)  W/O Rose Model	FRT12PSS	FRT12PPT
	4440	4440
Forza (Pair)  W/O Rose Model	FRZ12PSS	FRZ12PPT
	4790	4790
Forza (Pcs)  On Rose Model	FRZ18PRSS	FRZ18PRPT
	3260	3260
Forza (Pair)  W/O Rose Model	FRZ18PSS	FRZ18PPT
	6190	6190



Pull Handles	Finish Available	
	SS	PT
Forza (Pcs)  On Rose Model	FRZ12PRSS	FRZ12PRPT
	2645	2645

Pull Handles	Finish Available	
	SS/SC	PT
Atina (Pair)  Size 255mm	AI 08 PR SS	AI 08 PR PT
	4725	4725
Atina (Pcs)  Size 305mm	AI 10 PR SS	AI 10 PR PT
	2600	2600

Brass Pull Handles	Finish Available	
	SS/SC	PT
Zara (Pair)  Size 250.4mm	ZA 08 PR SS	ZA 08 PR PT
	3540	3540
Zara (Pcs)  Size 300.4mm	ZA 10 PR SS	ZA 10 PR PT
	1955	1955
Ebony (Pair)  Size 256mm	EB 08 PR SS	EB 08 PR PT
	4765	4765
Ebony (Pcs)  Size 306mm	EB 10 PR SS	EB 10 PR PT
	2830	2830
Leeba (Pcs)  Size 302mm	LE 08 PR SS	LE 08 PR PT
	2635	2635

Brass Pull Handles		Finish Available	
		SS/SC	PT
Leeba (Pcs)	 Size 357mm	LE 10 PR SS	LE 10 PR PT
		3575	3575
Delfino (Pcs)	 Size 252mm	DE 08 PR SS WC	DE 08 PR PT WC
		2735	2735
Delfino (Pcs)	 Size 307mm	DE 10 PR SS WC	DE 10 PR PT WC
		3010	3010
Xia (Pair)	 Size 252mm	XI 08 PR SS	XI 08 PR PT
		6010	6010
Xia (Pcs)	 Size 301mm	XI 10 PR SS	XI 10 PR PT
		3205	3205
Sirocco (Pcs)	 Size 293mm	SR 12 PR SS	SR 12 PR PT
		5295	5295
Versa (Pair)	 Size 171mm	VE 06 PR SS	VE 06 PR PT
		3350	3350
Versa (Pcs)	 Size 272.5mm	VE 10 PR SS	VE 10 PR PT
		2965	2965
Sana (Pair)	 Size 256mm	SN 08 PR SS	SN 08 PR PT
		5560	5560





Brass Pull Handles		Finish Available	
		SS/SC	PT
Nika (Pair)	 Size 262mm	NK 10 PR SS	NK 10 PR PT
		7150	7150
Galaxy (Pair)	 Size 252mm	GA 06 PR SS, GA 06 PR SC	GA 06 PR PT
		5535	5535
Arch (Pcs.)	 Size 303mm	ARH 10 P SS	ARH 10 P PT
		4125	4125
Madonna (Pair)	 Size 210mm	MA 10 PR SS	MA 10 PR PT
		4050	4050
Curve (Pair) - Glass Door	 Size 329.5mm	CUR 10 PGD SC	CUR 10 PGD PT
		5175	5175
Curve (Pair)	 Size 279.5mm	CUR 08 PWD SC	CUR 08 PWD PT
		4360	4360
Curve (Pcs)	 Size 329.5mm	CUR 10 PWD SC	CUR 10 PWD PT
		2625	2625
Curve (Pair) - Glass Door	 Size 279.5mm	CUR 08 PGD SC	CUR 08 PGD PT
		4840	4840

Stainless Steel Pull Handles (SS Grade-304)		Finish Available			
		SS			
Primo (Pair)	 <p>Size 180mm 230mm 282mm 330mm</p> <p>Fire Rated Upto 2 Hours</p>	PR 06 P SS	PR 08 P SS	PR 10 P SS	PR 12 P SS
		2040	2165	2355	2545
Eden (Pair)	 <p>Size 184mm 234mm 286mm 334mm</p> <p>Fire Rated Upto 2 Hours</p>	ED 06 P SS	ED 08 P SS	ED 10 P SS	ED 12 P SS
		1470	1620	1740	1905

Stainless Steel Pull Handles (SS Grade-304)		19mm dia		22mm dia			
		SS	SS	GM	TM		
D Type (Pair)	 <p>Fire Rated Upto 2 Hours</p>	150mm	SD06PSS	SD06PSS			
			1385	1470			
			200mm	SD08PSS	SD08PSS	SD08PGM	SD08PTM
				1545	1620	2165	2505
			250mm	SD10PSS	SD10PSS	SD10PGM	SD10PTM
				1670	1755	2415	2805
		300mm	SD12PSS	SD12PSS	SD12PGM	SD12PTM	
			1830	1905	2700	3130	
				25.4mm dia		32mm dia	
				SS	GM	TM	SS
		400mm	SD16PSS	SD16PGM	SD16PTM		SD24PSS
			2910	3960	4595	600mm	4050
SD18PSS					SD30PSS		
3130				750mm	4860		
SD20PSS					SD36PSS		
3360				900mm	5655		
500mm					SD48PSS		
				1200mm	7380		



Stainless Steel Pull Handles (SS Grade-304)		22mm dia			25.4mm dia			32mm dia	
		SS	GM	TM	SS	GM	TM	SS	
H Type (Pair)	 <p>Fire Rated Upto 2 Hours</p>	200mm	SH 08 P SS	SH 08 P GM	SH 08 P TM				
			2165	2700	3130				
		250mm	SH 10 P SS	SH 10 P GM	SH 10 P TM				
			2370	3035	3515				
		300mm	SH 12 P SS	SH 12 P GM	SH 12 P TM				
			2545	3345	3880				
		350mm				SH 14 P SS	SH 14 P GM	SH 14 P TM	
						3115	4170	4875	
		400mm				SH 16 P SS	SH 16 P GM	SH 16 P TM	
						3360	4425	5135	
		450mm				SH 18 P SS			
						3595			
600mm							SH 24 P SS		
							4830		
750mm							SH 30 P SS		
							5525		
900mm							SH 36 P SS		
							6230		
1200mm							SH 48 P SS		
							7635		



Stainless Steel Pull Handles (SS Grade-304)		22mm dia	
		SS	
SOP Type (Pair)		200mm	SO 08 P SS
			1620
		250mm	SO 10 P SS
			1740
300mm	SO 12 P SS		
	1905		
U Type (Pair)		200mm	SU 08 P SS
			2345
		250mm	SU 10 P SS
			2520
		300mm	SU 12 P SS
2685			





Mortise Locks		Description	Finish Available								Std. Pkg.
			SS	PT	SN	TM	GM	FM	CT	HG	
ML 124		Mortise Lock 60mm Backset, 3 Stroke Dead Bolt	ML 124								20
			1100	1100	1175	1175	1175	1175	1175	1775	
ML 110		Mortise Lock Standard	ML 110								20
			SS/PT		SN/TM		GM/FM		CT/CB/MR		
			1025		1080		1080		1080		1025
ML 100		Mortise Lock Premium	ML 100								20
			HG/FE/VG				SS/PT		NM		
			1620		1275		1725				
ML 124 R		Mortise Roller Lock 60 mm Backset 3 Stroke Dead Bolt	ML 124 R								20
			SS				PT				
			1265				1265				
MGT 602		Mortise Magnetic Lock 60 mm Backset (Silent Lock)	MGT 602								20
			SS								
			2500								

Mortise Locks		Description	Finish Available			Std. Pkg.
			NI	SS	PT	
ML 121		Mortise Lock 60mm Backset Heavy Duty 4 Pin	ML 121 SS	ML 121 PT	20	
			1610	1610		
ML 120		Mortise Lock (Four Pin)	ML 120 NI	ML 120 SS	ML 120 PT	20
			1480	1480	1480	
ML 111		Mortise Lock (Three Square Bolts)	ML 111 NI	ML 111 SS	20	
			1025	1025		
ML 170		Mortise Lock Small	ML 170 NI		20	
			775			



Mortise Locks		Description	Finish Available		Std. Pkg.
			SS		
ML110RC		Round Corner Mortise Lock (Standard)	ML RC 110 SS		20
			1025		





Mortise Locks		Description	Finish Available		Std. Pkg.
			NI	SS	
ML 160 (ECO)		Mortise 6 Lever Lock	ML 160 NI		20
			840		
ML 166 SS		6 Lever Mortise Dead Lock		ML 166 SS	20
				575	

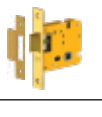





Mortise Dead Locks		Description	Finish Available					Std. Pkg.	
			NI	SS/PT	GM/TM	FM/SN	CB/MR		
ML 112		Mortise Dead Lock Standard	ML 112 NI	ML 112 SS/PT	ML 112 GM/TM	ML 112 FM/SN	ML 112 CB/MR	20	
			745	745	785	785	785		
ML 102		Mortise Dead Lock Premium	SS/PT		HG/VG		FE	NM	20
			ML 102 SS/PT		ML 102 HG/VG		ML 102 FE	ML 102 NM	
			1080		1420		1350	1530	
ML 104		Mortise Dead Lock with 60mm Backset	SS					20	
			ML 104 SS						
			1155						











Narrow Mortise Lock		Description	Finish Available		Std. Pkg.
			NI	SS	
ML 140		Mortise Lock With latch & Hook Bolt, Backset 21mm for Sliding Door	ML 140 NI		20
			950		
ML 141		Mortise Lock with Hook Bolt Backset 21mm for Sliding Door	ML 141 NI		20
			775		
ML 142		Mortise Lock With Dead Bolt, Backset 21mm for Narrow Stile		ML 142 SS	20
				575	
ML 144		Mortise Lock With Latch & Hook Bolt, Backset 21mm for Narrow Stile		ML 144 SS	20
				575	





Mortise Lock & Latch for Steel Doors		Description	Finish Available		Std. Pkg.
			SS		
ML 100D		Mortise Dead Lock for Steel Door	ML 100 D SS		20
			1005		
ML 100A		Mortise Lock for Steel Door	ML100 A SS		20
			1275		
ML 100L		Mortise Latch for Steel Door	ML 100 L SS		20
			900		











Mortise Latch		Description	Finish Available				Std. Pkg.
			NI	SS/PT	HG/FE/VG	NM	
ML 103		Mortise Latch Standard	ML 103				20
			710	710	930	1040	
ML 103A		Mortise Latch Standard	GM	SN/TM	CT/FM	CB/MR	20
			ML 103 A				
			750	750	750	750	

Mortise Lock					
		Description	Finish Available		Std. Pkg.
			SS		
ML 100	 <small>Fire Rated Upto 2 Hours</small>	Mortise Sash Lock-Fire Rated 50mm Backset	ML 100 SS (FR)	1895	20
		Mortise Sash Lock-Fire Rated 55mm Backset	ML 101 SS (FR)		
ML 100L	 <small>Fire Rated Upto 2 Hours</small>	Mortise Latch Lock-Fire Rated 50mm Backset	ML 100L SS (FR)	1700	20
		Mortise Latch Lock-Fire Rated 55mm Backset	ML 101L SS (FR)		
ML 100D	 <small>Fire Rated Upto 2 Hours</small>	Mortise Dead Lock-Fire Rated 50mm Backset	ML 100D SS (FR)	1700	20
		Mortise Dead Lock-Fire Rated 55mm Backset	ML 101D SS (FR)		
ML 103L	 <small>NEW</small> <small>Fire Rated Upto 2 Hours</small>	Mortise Sash Lock-Fire Rated 55mm Backset	ML 103L SS (FR)	1480	20
ML 103D	 <small>NEW</small> <small>Fire Rated Upto 2 Hours</small>	Mortise Sash Lock-Fire Rated 55mm Backset	ML 103D SS (FR)	1480	20

Euro Profile Cylinders	Description	Finish Available						Std. Pkg.
		SS/PT	SN/TM	GM	FM/CT	CB/MR	HG/FE	
CL 100	 Both Side Key 60mm	CL 100						20
		740	780	780	780	780	895	
CL 101	 Key and Knob 60mm	CL 101						20
		820	865	865	865	865	975	
CL 102	 Coin & Knob 60mm	CL 102						20
		740	780	780	780	780	895	
CL 106	 Both Side Key 70mm	CL 106						20
		795	835	835	835	835	960	
CL 107	 Key and Knob 70mm	CL 107						20
		875	920	920	920	920	1045	
CL 108	 Coin & Knob 70mm	CL 108						20
		795	835	835	835	835	960	

Euro Profile Cylinders	Description	Finish Available						Std. Pkg.
		SS/PT	SN/TM	GM	FM/CT	HG/FE/VG	NM	
CL 200	 Both Side Key 60mm	CL 200						20
		1070	1150	1150	1150	1290	1395	
CL 201	 Key and Knob 60mm	CL 201						20
		1145	1225	1225	1225	1360	1470	
CL 202	 Coin and Knob 60mm	CL 202						20
		1070	1150	1150	1150	1290	1395	
CL 206	 Both Side Key 70mm	CL 206						20
		1130	1215	1215	1215	1350	1455	
CL 207	 Key and Knob 70mm	CL 207						20
		1205	1290	1290	1290	1435	1545	
CL 208	 Coin and Knob 70mm	CL 208						20
		1130	1215	1215	1215	1350	1455	
CL 203	 Both Side Key 80mm	CL 203						20
		1225	1320	1320	1320	1445	1555	
CL 204	 Key and Knob 80mm	CL 204						20
		1295	1400	1400	1400	1540	1645	
CL 205	 Coin and Knob 80mm	CL 205						20
		1225	1320	1320	1320	1445	1555	
CL 214	 Both Side Key 90mm	CL 214						20
		1470	1585	1585	1585	1720	1825	

Euro Profile Cylinders	Description	Finish Available						Std. Pkg.
		SS/PT	SN/TM	GM	FM/CT	HG/FE/VG	NM	
CL 215	 Key and Knob 90mm	CL 215						20
		1550	1660	1660	1660	1805	1910	
CL 216	 Coin and Knob 90mm	CL 216						20
		1470	1585	1585	1585	1720	1825	
CL 211	 Both Side Key 100mm	CL 211						20
		1550	1660	1660	1660	1805	1910	
CL 212	 Key and Knob 100mm	CL 212						20
		1620	1735	1735	1735	1875	1985	
CL 213	 Coin and Knob 100mm	CL 213						20
		1550	1660	1660	1660	1805	1910	

Computerized Key Cylinders	Description	Finish Available		Std. Pkg.
		SS	PT	
CL 400	 Both Side Key 60mm	CL 400		20
		795	795	
CL 401	 Key and Knob 60mm	CL 401		20
		865	865	
CL 406	 Both Side Key 70mm	CL 406		20
		850	850	
CL 407	 Key and Knob 70mm	CL 407		20
		935	935	
CL 403	 Both Side Key 80mm	CL 403		20
		1350	1350	
CL 404	 Key and Knob 80mm	CL 404		20
		1410	1410	
CL 414	 Both Side Key 90mm	CL 414		20
		1520	1520	
CL 415	 Key and Knob 90mm	CL 415		20
		1595	1595	
CL 411	 Both Side Key 100mm	CL 411		20
		1595	1595	
CL 412	 Key and Knob 100mm	CL 412		20
		1660	1660	

CL-400 series cylinder will have 3 keys.

Computerized Key Cylinders	HYBRID TWO TRACK TECHNOLOGY KEY	Description	Finish Available						Std. Pkg.
			SS/PT	SN/TM	GM/CB/MR	FM/CT	HG/FE/VG	NM	
CL 500		Both Side Key 60mm	CL 500						20
			890	975	975	975	1095	1200	
CL 501		Key and Knob 60mm	CL 501						20
			965	1060	1060	1060	1175	1280	
CL 502		Coin and Knob 60mm	CL 502						20
			890	975	975	975	1095	1200	
CL 506		Both Side Key 70 mm	CL 506						20
			955	1045	1045	1045	1165	1270	
CL 507		Key and Knob 70mm	CL 507						20
			1025	1125	1125	1125	1235	1340	
CL 508		Coin and Knob 70mm	CL 508						20
			955	1045	1045	1045	1165	1270	
CL 503		Both Side Key 80mm	CL 503						
			1445	1585	1585	1585	1700	1805	
CL 504		Key and Knob 80mm	CL 504						
			1510	1645	1645	1645	1760	1865	
CL 505		Coin and Knob 80mm	CL 505						
			1445	1585	1585	1585	1700	1805	
CL 514		Both Side Key 90mm	CL 514						
			1700	1760	1760	1760	1885	1995	
CL 515		Key and Knob 90mm	CL 515						
			1680	1845	1845	1845	1975	2080	
CL 516		Coin and Knob 90mm	CL 516						
			1615	1760	1760	1760	1885	1995	
CL 511		Both Side Key 100mm	CL 511						
			1680	1845	1845	1845	1975	2080	
CL 512		Key and Knob 100mm	CL 512						
			1760	1920	1920	1920	2055	2160	
CL 513		Coin and Knob 100mm	CL 513						
			1765	1845	1845	1845	1975	2080	

CL-500 series cylinder will have 5 keys.

DEFENDER 5 HIGH SECURITY EURO PROFILE CYLINDER	Description	Finish Available						Std. Pkg.
		SS/PT	SN/TM	HG/FE	CB/MR	NM	VG	
DF 200	Both Side Key 60mm	DF 200						20
		1780	2045	2180	1945	2175	2075	
DF 201	Key and Knob 60mm	DF 201						20
		1840	2110	2245	2005	2235	2135	
DF 206	Both Side Key 70mm	DF 206						20
		1840	2110	2245	2005	2235	2135	
DF 207	Key and Knob 70mm	DF 207						20
		1965	2235	2380	2125	2370	2265	
DF 203	Both Side Key 80mm	DF 203						
		1965	2235	2380	2125	2370	2265	
DF 204	Key and Knob 80mm	DF 204						
		2025	2300	2450	2190	2430	2330	

DEFENDER 5 HIGH SECURITY EURO PROFILE CYLINDER	Description	MK	MK + GMK
	MK & GMK Charges per Euro Profile Cylinder		
	Upto 20 Cylinders	243 per cylinder	243+243=486
	From 21 to 50 Cylinders	325 per cylinder	325+325=650
	From 51 and above Cylinders	451 per cylinder	451+451=902

Construction Key Cylinder

Note: Construction Key cylinder is available in Euro Profile Cylinder Additional Charges for construction key cylinder (2 Keys) Rs.225/-

Owner Key

Construction Key stop working when the Owner key is used for the very first time.

Construction Key

Separate construction Key to be used by the workers during construction.

During Construction



Only construction key being used











After Possession

Owner Key used for the first time

Thereafter







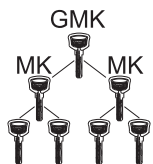

Only Owner key is capable for Locking/Unlocking

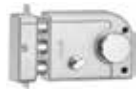
Euro Profile Half Cylinders		Description	Finish Available	
			SS	PT
CL 200H		One Side Key 60mm	CL 200 H	
			940	940
CL 201H		One Side Knob 60mm	CL 201 H	
			940	940
CL 206H		One Side Key 70mm	CL 206 H	
			1020	1020
CL 207H		One Side Knob 70mm	CL 207 H	
			1020	1020
CL 203H		One Side Key 80mm	CL 203 H	
			1180	1180
CL 204H		One Side Knob 80mm	CL 204 H	
			1180	1180
CL 214 H		One Side Key 90mm	CL 214 H	
			1415	1415
CL 215 H		One Side Knob 90mm	CL 215 H	
			1440	1440
CL 211H		One Side Key 100mm	CL 211 H	
			1510	1510
CL 212H		One Side Knob 100mm	CL 212 H	
			1510	1510



Computerized Key Cylinders		Description	Finish Available		Std. Pkg.
			SS	PT	
CL 400H		One Side Key 60mm	CL 400		20
			665	665	
CL 401H		One Side Knob 60mm	CL 401		20
			735	735	
CL 406H		One Side Key 70mm	CL 406		20
			720	720	
CL 407H		One Side Knob 70mm	CL 407		20
			800	800	
CL 403H		One Side Key 80mm	CL 403		20
			1220	1220	
CL 404H		One Side Knob 80mm	CL 404		20
			1275	1275	
CL 414H		One Side Key 90mm	CL 414		20
			1385	1385	
CL 415H		One Side Knob 90mm	CL 415		20
			1465	1465	
CL 411H		One Side Key 100mm	CL 411		20
			1465	1465	
CL 412H		One Side Knob 100mm	CL 412		20
			1530	1530	

CL-400 series cylinder will have 3 keys.



MK & GMK Charges per Euro Profile Cylinder	Description	MK	MK + GMK
	Upto 20 Cylinders	177 per cylinder	177+177=354
	From 21 to 50 Cylinders	271 per cylinder	271+271=542
	From 51 and above Cylinders	353 per cylinder	353+353=706

PHANTOM ...Your Guardian		Product Name & Description	IV	NS	MPT
PHA 300		Trio Lock Both Side Key Model	2545	3955	4055
PHA 301		Trio Lock Key and Knob Model	2360	3580	3670
PHA 302		Trio Lock Dead Bolt Both Side Key Model	2740	3685	3795
PHA 303		Trio Lock Dead Bolt Key and Knob Model	2235	3335	3440
PHA 103		Dead Lock Key and Knob Model	1835	1980	2080
PHA 102		Dead Lock Both Side Key Model	2025	2180	2285
PHA 100		Night Latch Both Side Key Model For Inside Opening	2620	2820	2915
PHA 101		Night Latch Key and Knob Model For Inside Opening	1715	2590	2700
PHA104		Night Latch Both Side Key Model For Inside Opening	2005	2005	2205
PHA105		Night Latch Key and Knob Model For Inside Opening	1800	1800	2005

PHANTOM ...Your Guardian		Product Name & Description	IV (O/S)	NS (O/S)	MPT (O/S)
PHA 100		Night Latch Both Side Key Model For Out side Opening	2620	2820	2915
PHA 101		Night Latch Key and Knob Model For Out side Opening	1715	2590	2700
PHA104		Night Latch Both Side Key Model For Out side Opening	2005	2005	2205
PHA105		Night Latch Key and Knob Model For Out side Opening	1800	1800	2005

PHANTOM ...Your Guardian		Product Name & Description	IV	NS	MPT
PHA 200		Verti Lock Both Side Key Model	2515	3400	3510
PHA 201		Verti Lock Key and Knob Model	2040	2985	3090

SMART SERIES		Product Name & Description	IV (O/S)	NS (O/S)	MPT (O/S)
SM 100		Night Latch Both Side Key Model For Out side Opening	1610	1735	1840
SM 101		Night Latch Key and Knob Model For Out side Opening	1570	1655	1755
SM 104		Night Latch Both Side Key Model For Out side Opening	1365	1500	1620
SM 105		Night Latch Key and Knob Model For Out side Opening	1165	1295	1420

SMART SERIES		Product Name & Description	IV	NS	MPT
SM 100		Night Latch Both Side Key Model For Inside Opening	1610	1735	1840
SM 101		Night Latch Key and Knob Model For Inside Opening	1570	1655	1755
SM 102		Dead Lock Both Side Key Model	1425	1535	1535
SM 103		Dead Lock Key and Knob Model	1175	1260	1260
SM 104		Night Latch Both Side Key Model For Inside Opening	1365	1500	1620
SM 105		Night Latch Key and Knob Model For Inside Opening	1165	1295	1420

Suitable For : Main Entrance Doors & 30-60 mm thick Doors
Applicable for Inside/Outside door opening

Farrëtto Collection						
PHANTOM ...Your Guardian		Product Name & Description	FM	TM	SN	HGFE
PHA 300		Trio Lock Both Side Key Model	4055	4055	4055	4450
PHA 301		Trio Lock Key and Knob Model	3670	3670	3670	4130
PHA 302		Trio Lock Dead Bolt Both Side Key Model	3795	3795	3795	4045
PHA 303		Trio Lock Dead Bolt Key and Knob Model	3440	3440	3440	3670

MK & GMK charges per SM Series Rim Lock	Description	MK	MK + GMK
	Upto 20 Cylinders	177 per cylinder	177+177=354
	From 21 to 50 Cylinders	271 per cylinder	271+271=542
	From 51 and above Cylinders	353 per cylinder	353+353=706

MK charges per Phantom Series Rim Lock	Description	MK
	Upto 20 Cylinders	243 per cylinder
	From 21 to 40 Cylinders	341 per cylinder

- 01. Construction Key Charges: 225/-
- 02. Key Alike and common key feature is also available in both Phantom and Smart Series Rim Locks.

ZOD (Rim Pull Handle)	Description	SC	MPT
ZOD		ZOD00PR SC	ZOD00PR PT
	Rim Pull Handle suitable with Phantom series	1145	1145
ZOD		ZOD0000 SC	ZOD0000 PT
	Rim Pull Handle Suitable With Phantom series	1145	1145

CONSTRUCTION KEY

Owner Key

Construction Key stop working when the Owner key is used for the very first time.

Construction Key

Separate construction Key to be used by the workers during construction.

During Construction

Only construction key being used

Home Possession

Owner Key used for the first time



Thereafter

Only Owner key is capable for Locking/Unlocking

HOME SOLUTION WITH MASTER KEY

1 CENTRAL KEY WILL WORK FOR BOTH MAIN DOOR RIM LOCK & ALL THE INTERNAL DOORS



*This feature only comes with smart series rim locks

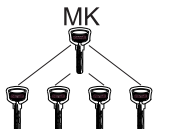





Knob Set	Description	Finish Available		Std. Pkg.
		S/S	A/B	
PRTO SM ETTO SM (SS)	 Entrance Smart	955		30
PRTO SM (SS)	 Privacy Smart	890		30
ETTO	 Entrance	1075	1150	24
PRTO	 Privacy	1000	1070	24

MK Charges per Knob Set	Description	MK
	Upto 24 Cylinders	149 extra per lock

Note: Master Key Only Available in SS Finish.

Multipurpose Locks	Description	Finish Available	Std. Pkg.
		NI/SS	
MP 390 (NI)	 Multipurpose Lock	145	120
MP 330 (NI)	 Multipurpose Lock Eco (round)	200	240
MP 360 (KA)	 Multipurpose Lock 22mm (sqr.)	210	120
MP 370 (KA)	 Multipurpose Lock 32mm (sqr.)	220	120

Multipurpose Locks	Description	Finish Available	Std. Pkg.
		NI	
MP 460 (KA)	 Multipurpose Lock 22mm (sqr.)	275	120
MP 470	 Multipurpose Lock 32mm (sqr.)	285	120
MP 490	 (SMART SUPERIA) Multipurpose Lock (sqr.)	255	120
AL 408	 (SWITCH LOCK) Wardrobe Lock	425	60

Secura Lock	Description	Finish Available	Std. Pkg.
		SS	
SECURA		AL 400 (20) 605	20
		AL 400 (25) 605	20
		AL 401 (32) 625	20
SMART SECURA		SM 400 (23) 445 SM 401 (32) 480	20
SECURA		AL 402 (38) 695	20
SECURA		AL 410 (20) 455	60
		AL 411 (25) 475	60
		AL 412 (32) 560	60
		AL 210 (20) 410	60
SECURA		AL 211 (25) 445	60
		AL 212 (32) 505	60
		SM 210 SS/IV 280 / 255	20
SMART SECURA		SM 211 SS/IV 320 / 300	20
		SM 212 SS/IV 375 / 355	20

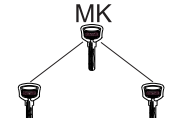
MK Charges per Secura Lock	Description	MK
	Upto 20 Locks	300
	21 to 40 Locks	300 + 50 (PER LOCKS)

Sliding Lock	Description	Finish Available	Std. Pkg.
		NS	
AL 500		AL 500 (25) 730	20
		AL 501 (32) 780	20

Hextech Lock	Description	Finish Available	Std. Pkg.
		SS	
AL 450 SS		AL 450 605	20

Note: Key Alike sets are available in code MP360, MP370, MP460, AL400, AL401, AL410, AL 411, AL 450, SM 400 & SM 401, AL 500, AL 501.

GUIDELINES FOR ORDERING COMBO SET

HL Lock Set (e.g ZOVI)

Available as a set of 8" mortise Handles & mortise lock body (ML 170) & with or without cylinder.

For ordering HL concept with variable cylinder options, use below mentioned product code system

Handle Cylinder Option	Cylinder Sizes	
	60mm	70mm
Both Side Key	HL ZOV SS	HL ZOV 06 SS
Knob and Key	HL ZOV A SS	HL ZOV 07 SS
Coin and Knob	HL ZOV 02 SS	HL ZOV 08 SS
Mortise Latch	HL ZOV B SS	
Mortise Lever Lock (KY)	HL ZOV SS (KY)	
Without Cylinder	HL ZOV SS (W/O CL)	

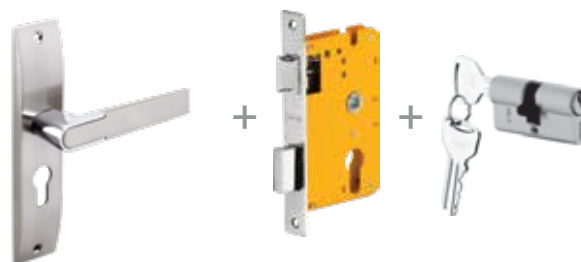

ML Lock Set (e.g Zovi)

Available as a set of 10" Mortise handles & mortise lock body (ML110) & with or without cylinder.

For ordering ML concept with variable cylinder options, use below mentioned product code system.

Handle Cylinder Option	Cylinder Sizes	
	60mm	70mm
Both Side Key	ML ZOV SS	ML ZOV 06 SS
Knob and Key	ML ZOV A SS	ML ZOV 07 SS
Coin and Knob	ML ZOV 02 SS	ML ZOV 08 SS
Without Cylinder	ML ZOV SS (W/O CL)	

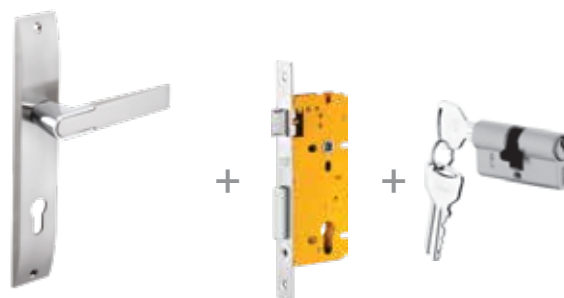

ML OR Lock Set (e.g Zovi)



Available as a set of Rosette handles & mortise lock body (ML 110) & with or without cylinder.

For ordering ML OR concept with variable cylinder options, use below mentioned product code system.

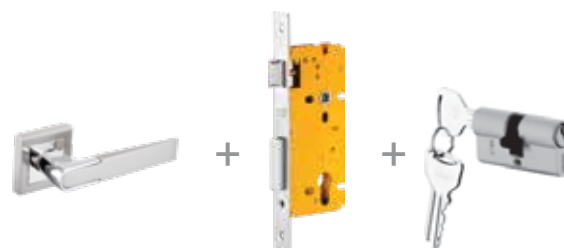
Handle Cylinder Option	Cylinder Sizes	
	60mm	70mm
Both Side Key	ML ZOV OR SS	ML ZOV OR 06 SS
Knob and Key	ML ZOV OR A SS	ML ZOV OR 07 SS
Coin and Knob	ML ZOV OR 02 SS	ML ZOV OR 08 SS
Mortise Latch	ML ZOV WR SS	
Without Cylinder	ML ZOV OR SS (W/O CL)	





Lock Sets | HL Series (8" On Plate) Combo Set

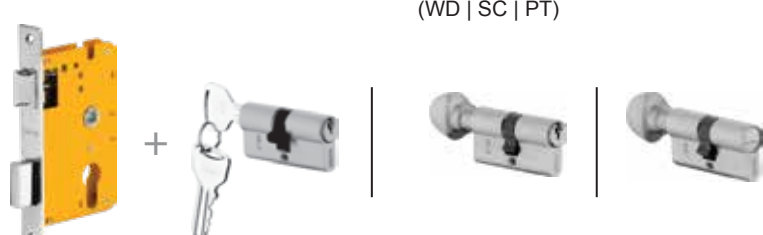

	Description	Finish Available		Std. Pkg.
		GMHG	CBGM / MRGM GMWD	
Kaira-X Amoli  HL KAI (GMHG GMWD) Size 200mm HL AML (CBGM MRGM) Size 200mm 	With Both Side Key Cylinder (60mm)	3465	3360	4
	With Knob and Key Cylinder (60mm)	3515	3410	4
	With Coin and Knob Cylinder (60mm)	3465	3360	4
	With Both Side Key Cylinder (70mm)	3515	3410	4
	With Knob and Key Cylinder (70mm)	3580	3480	4
	With Coin and Knob Cylinder (70mm)	3515	3410	4

Lock Sets | HL Series (8" On Plate) Combo Set

	Description	Finish Available		Std. Pkg.
		SS/SC/ PT	WD	
Zovi Kaira Odiun Texa  HL ZOV HL KAI HL ODI (WD SC PT) HL TEX 	With Both Side Key Cylinder (60mm)	2765	2835	4
	With Knob and Key Cylinder (60mm)	2835	2890	4
	With Coin and Knob Cylinder (60mm)	2765	2835	4
	With Both Side Key Cylinder (70mm)	2835	2890	4
	With Knob and Key Cylinder (70mm)	2890	2950	4
	With Coin and Knob Cylinder (70mm)	2835	2890	4
	With Mortise Lever Lock (KY)	2210	2275	4

Hale | Dash

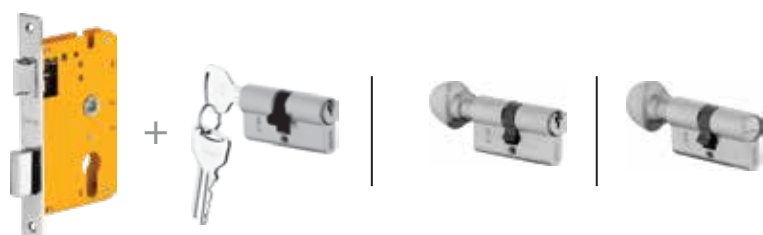
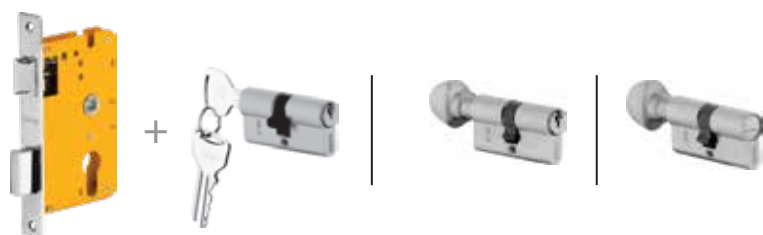
 HL HALE Size 190mm HL DAS Size 204.3mm 	With Both Side Key Cylinder (60mm)	3380		4
	With Knob and Key Cylinder (60mm)	3440		4
	With Coin and Knob Cylinder (60mm)	3380		4
	With Both Side Key Cylinder (70mm)	3440		4
	With Knob and Key Cylinder (70mm)	3500		4
	With Coin and Knob Cylinder (70mm)	3440		4
	With Mortise Lever Lock (KY)	2465		4

Lock Sets HL Series (8" On Plate) Combo Set		Description	Finish Available	Std. Pkg.
			SS/SC/ PT	
<p>Deolo</p>  <p>HL DEO Size 200mm</p> 	With Both Side Key Cylinder (60mm)	3705	4	
	With Knob and Key Cylinder (60mm)	3765	4	
	With Coin and Knob Cylinder (60mm)	3705	4	
	With Both Side Key Cylinder (70mm)	3775	4	
	With Knob and Key Cylinder (70mm)	3840	4	
	With Coin and Knob Cylinder (70mm)	3775	4	
	With Mortise Lever Lock (KY)	2515	4	
<p>Zara</p>  <p>HL ZA Size 200mm</p> 	With Both Side Key Cylinder (60mm)	3840	4	
	With Knob and Key Cylinder (60mm)	3900	4	
	With Coin and Knob Cylinder (60mm)	3840	4	
	With Both Side Key Cylinder (70mm)	3910	4	
	With Knob and Key Cylinder (70mm)	3980	4	
	With Coin and Knob Cylinder (70mm)	3910	4	
	With Mortise Lever Lock (KY)	2550	4	
<p>Ceto Elina</p>  <p>HL CO Size 185mm</p> <p>HL ELN Size 200mm</p> 	With Both Side Key Cylinder (60mm)	4010	4	
	With Knob and Key Cylinder (60mm)	4075	4	
	With Coin and Knob Cylinder (60mm)	4010	4	
	With Both Side Key Cylinder (70mm)	4075	4	
	With Knob and Key Cylinder (70mm)	4135	4	
	With Coin and Knob Cylinder (70mm)	4075	4	
	With Mortise Lever Lock (KY)	2705	4	

Lock Sets HL Series (8" On Plate) Combo Set	Description	Finish Available		Std. Pkg.
		SS/ SC/ PT		
Dave Onix  HL DAV Size 190mm HL ON Size 185mm 	With Both Side Key Cylinder (60mm)	4190		4
	With Knob and Key Cylinder (60mm)	4250		4
	With Coin and Knob Cylinder (60mm)	4190		4
	With Both Side Key Cylinder (70mm)	4250		4
	With Knob and Key Cylinder (70mm)	4320		4
	With Coin and Knob Cylinder (70mm)	4250		4
	With Mortise Lever Lock (KY)	3000		4
	Stella Cosmo Noha  HL ST Size 204mm HL CS Size 204mm HL NO Size 204mm 	With Both Side Key Cylinder (60mm)	4250	
With Knob and Key Cylinder (60mm)		4320		4
With Coin and Knob Cylinder (60mm)		4250		4
With Both Side Key Cylinder (70mm)		4330		4
With Knob and Key Cylinder (70mm)		4390		4
With Coin and Knob Cylinder (70mm)		4330		4
With Mortise Lever Lock (KY)		2965		4

Latch Sets HL Series (8" On Plate) Combo Set	Description	Finish Available		Std. Pkg.
		GMHG	CBGM / MRGM GMWD	
Kaira-X	With Mortise Latch	2740	2530	4
Amoli	With Mortise Latch		2530	4

Latch Sets HL Series (8" On Plate) Combo Set	Description	Finish Available		Std. Pkg.
		SS/SC/ PT	SSWD	
Zovi Kaira Odiun Texa	With Mortise Latch	2180	2245	4
Hale Dash	With Mortise Latch	2410		4
Deolo	With Mortise Latch	2605		4
Zara	With Mortise Latch	2705		4
Ceto Elina	With Mortise Latch	2705		4
Dave Onix	With Mortise Latch	3000		4
Stella Cosmo Noha	With Mortise Latch	2965		4

Lock Sets K Series	K series	Description	Finish Available- SC/PT			Std. Pkg.
			CHORD	OBLO	BRITO	
<p>Chord Oblo Brito</p>  <p>HL CHO SC Size 178mm HL OBL SC Size 175mm HL BRT SC Size 178mm</p> <p>K PLUS</p>	K series	With Both Side Key Cylinder (60mm)	2650	2265	2615	4
		With Key & Knob Cylinder (60mm)	2715	2330	2670	4
		With Both Side Key Cylinder (70mm)	2715	2330	2670	4
		With Key & Knob Cylinder (70mm)	2770	2385	2735	4



Lock Sets K Series	K series	Description	Finish Available- SC/PT		Std. Pkg.
			SKEW	BOW	
<p>Skew Bow</p>  <p>HL SKE SC Size 175mm HL BOW SC Size 176mm</p> <p>K PLUS</p>	K series	With Both Side Key Cylinder (60mm)	2615	2650	4
		With Key & Knob Cylinder (60mm)	2670	2715	4
		With Both Side Key Cylinder (70mm)	2670	2715	4
		With Key & Knob Cylinder (70mm)	2735	2770	4

Lock Sets K Series	Description	Finish Available- SC/PT			Std.
		CHORD	OBLO	BRITO	
<p>Chord Oblo Brito</p>  <p>HL CHO SC Size 178mm HL OBL SC Size 175mm HL BRT SC Size 178mm</p> <p>Ky</p>	With Mortise Lever Lock (KY)	2040	1545	1545	6

Lock Sets K Series	Description	Finish Available- SC/PT		Std. Pkg.
		SKEW	BOW	
<p>Skew Bow</p>  <p>HL SKE SC Size 175mm HL BOW SC Size 176mm</p> <p>Ky</p>	With Mortise Lever Lock (KY)	1700	1740	6

Lock Sets Smart K Series	Description	Finish Available- SS/PT		Std. Pkg.
		BRITO	OBLO	
<p>Brito Smart Oblo Smart</p>  <p>HL BRT KSS (SM) Size 175mm HL OBL KSS (SM) Size 176mm</p> <p>Ky</p>	With Mortise Lever Lock (KY)	1460	1460	6

Latch Sets K Series	Description	Finish Available	Std. Pkg.
		SC/PT	
Skew Bow Chord	With Mortise Latch	1555	4
Oblo Brito	With Mortise Latch	1405	4

Lock Sets ML Series (10" On Plate) Combo Set	Description	Finish Available		Std. Pkg.
		GMHG	CBGM / MRGM GMWD	
Kaira-X Amoli  ML KAI (GMHG GMWD) ML AML (CBGM MRGM) 	With Both Side Key Cylinder (60mm)	3900	3795	4
	With Knob and Key Cylinder (60mm)	3975	3870	4
	With Coin and Knob Cylinder (60mm)	3900	3795	4
	With Both Side Key Cylinder (70mm)	3975	3870	4
	With Knob and Key Cylinder (70mm)	4040	3935	4
	With Coin and Knob Cylinder (70mm)	3975	3870	4





Lock Sets ML Series (10" On Plate) Combo Set	Description	Finish Available		Std. Pkg.
		SS/SC/PT	WD	
Zovi Kaira Odiun Texa  ML ZOV ML KAI ML ODI (WD SC PT) ML TEX 	With Both Side Key Cylinder (60mm)	3190	3265	4
	With Knob and Key Cylinder (60mm)	3265	3320	4
	With Coin and Knob Cylinder (60mm)	3190	3265	4
	With Both Side Key Cylinder (70mm)	3265	3320	4
	With Knob and Key Cylinder (70mm)	3320	3380	4
	With Coin and Knob Cylinder (70mm)	3265	3320	4
Hale Dash  ML HALE Size 240mm ML DAS Size 253.8mm 	With Both Side Key Cylinder (60mm)	3790		4
	With Knob and Key Cylinder (60mm)	3850		4
	With Coin and Knob Cylinder (60mm)	3790		4
	With Both Side Key Cylinder (70mm)	3850		4
	With Knob and Key Cylinder (70mm)	3910		4
	With Coin and Knob Cylinder (70mm)	3850		4

Lock Sets ML Series (10" On Plate) Combo Set		Description	Finish Available	Std. Pkg.
			SS/SC/PT	
<p>Deolo</p>  <p>ML DEO Size 250mm</p> 	With Both Side Key Cylinder (60mm)	4190	4	
	With Knob and Key Cylinder (60mm)	4250	4	
	With Coin and Knob Cylinder (60mm)	4190	4	
	With Both Side Key Cylinder (70mm)	4250	4	
	With Knob and Key Cylinder (70mm)	4320	4	
	With Coin and Knob Cylinder (70mm)	4250	4	
<p>Zara</p>  <p>ML ZA Size 250mm</p> 	With Both Side Key Cylinder (60mm)	4250	4	
	With Knob and Key Cylinder (60mm)	4320	4	
	With Coin and Knob Cylinder (60mm)	4250	4	
	With Both Side Key Cylinder (70mm)	4330	4	
	With Knob and Key Cylinder (70mm)	4390	4	
	With Coin and Knob Cylinder (70mm)	4330	4	
<p>Ceto Elina</p>  <p>ML CO Size 250mm</p> <p>ML ELN Size 250mm</p> 	With Both Side Key Cylinder (60mm)	4565	4	
	With Knob and Key Cylinder (60mm)	4620	4	
	With Coin and Knob Cylinder (60mm)	4565	4	
	With Both Side Key Cylinder (70mm)	4620	4	
	With Knob and Key Cylinder (70mm)	4690	4	
	With Coin and Knob Cylinder (70mm)	4620	4	

Lock Sets ML Series (10" On Plate) Combo Set		Description	Finish Available	Std. Pkg.
			SS/SC/PT	
<p>Dave Onix</p>  <p>ML DAV Size 240mm</p> <p>ML ON Size 250mm</p>	With Both Side Key Cylinder (60mm)	4620	4	
	With Knob and Key Cylinder (60mm)	4690	4	
	With Coin and Knob Cylinder (60mm)	4620	4	
	With Both Side Key Cylinder (70mm)	4705	4	
	With Knob and Key Cylinder (70mm)	4765	4	
	With Coin and Knob Cylinder (70mm)	4705	4	
	<p>Stella Cosmo Noha</p>  <p>ML ST Size 223mm</p> <p>ML CS Size 245mm</p> <p>ML NO Size 245mm</p>	With Both Side Key Cylinder (60mm)	4740	4
With Knob and Key Cylinder (60mm)		4795	4	
With Coin and Knob Cylinder (60mm)		4740	4	
With Both Side Key Cylinder (70mm)		4795	4	
With Knob and Key Cylinder (70mm)		4860	4	
With Coin and Knob Cylinder (70mm)		4795	4	

Lock Sets ML Series (On Rose) Combo Set	Description	Finish Available		Std. Pkg.
		GMHG	CBGM / MRGM GMWD	
<p>Kaira-X Amoli</p> <p>ML KAI OR (GMHG GMWD) ML AML OR (CBGM MRGM)</p>	With Both Side Key Cylinder (60mm)	4025	3920	4
	With Knob and Key Cylinder (60mm)	4095	3995	4
	With Coin and Knob Cylinder (60mm)	4025	3920	4
	With Both Side Key Cylinder (70mm)	4095	3995	4
	With Knob and Key Cylinder (70mm)	4165	4060	4
	With Coin and Knob Cylinder (70mm)	4095	3995	4



Lock Sets ML Series (On Rose) Combo Set	Description	Finish Available		Std. Pkg.
		SS/SC/ PT	WD	
<p>Zovi Kaira Odiun Texa</p> <p>ML ZOV OR ML KAI OR ML ODI OR (WD SC PT) ML TEX OR</p>	With Both Side Key Cylinder (60mm)	3320	3380	4
	With Knob and Key Cylinder (60mm)	3380	3445	4
	With Coin and Knob Cylinder (60mm)	3320	3380	4
	With Both Side Key Cylinder (70mm)	3380	3445	4
	With Knob and Key Cylinder (70mm)	3445	3500	4
	With Coin and Knob Cylinder (70mm)	3380	3445	4
<p>Hale Dash</p> <p>ML HALE OR (Size 52.5mm) ML DAS OR (Size 52.5mm)</p>	With Both Side Key Cylinder (60mm)	3925		4
	With Knob and Key Cylinder (60mm)	3990		4
	With Coin and Knob Cylinder (60mm)	3925		4
	With Both Side Key Cylinder (70mm)	3990		4
	With Knob and Key Cylinder (70mm)	4050		4
	With Coin and Knob Cylinder (70mm)	3990		4



Lock Sets ML Series (On Rose) Combo Set		Description	Finish Available	Std. Pkg.
			SS/SC/PT	
<p>Deolo</p>  <p>ML DEO OR Size 50.4mm</p> 	With Both Side Key Cylinder (60mm)	4330	4	
	With Knob and Key Cylinder (60mm)	4390	4	
	With Coin and Knob Cylinder (60mm)	4330	4	
	With Both Side Key Cylinder (70mm)	4390	4	
	With Knob and Key Cylinder (70mm)	4450	4	
	With Coin and Knob Cylinder (70mm)	4390	4	
<p>Zara</p>  <p>ML ZA OR Size 50.4mm</p> 	With Both Side Key Cylinder (60mm)	4740	4	
	With Knob and Key Cylinder (60mm)	4795	4	
	With Coin and Knob Cylinder (60mm)	4740	4	
	With Both Side Key Cylinder (70mm)	4795	4	
	With Knob and Key Cylinder (70mm)	4860	4	
	With Coin and Knob Cylinder (70mm)	4795	4	
<p>Ceto Elina</p>  <p>ML CO OR Size 54mm</p>  <p>ML ELN OR Size 52.5mm</p> 	With Both Side Key Cylinder (60mm)	4740	4	
	With Knob and Key Cylinder (60mm)	4795	4	
	With Coin and Knob Cylinder (60mm)	4740	4	
	With Both Side Key Cylinder (70mm)	4795	4	
	With Knob and Key Cylinder (70mm)	4860	4	
	With Coin and Knob Cylinder (70mm)	4795	4	



Lock Sets ML Series (On Rose) Combo Set		Description	Finish Available		Std. Pkg.
			SS/SC/ PT		
<p>Dave Onix</p>  <p>ML DAV OR Size 54mm</p> <p>ML ON OR Size 52mm</p> 	With Both Side Key Cylinder (60mm)	4795	4		
	With Knob and Key Cylinder (60mm)	4860	4		
	With Coin and Knob Cylinder (60mm)	4795	4		
	With Both Side Key Cylinder (70mm)	4875	4		
	With Knob and Key Cylinder (70mm)	4940	4		
	With Coin and Knob Cylinder (70mm)	4875	4		
<p>Stella Cosmo Noha</p>  <p>ML ST OR Size 55mm</p> <p>ML CS OR Size 55mm</p> <p>ML NO OR Size 54mm</p> 	With Both Side Key Cylinder (60mm)	4875	4		
	With Knob and Key Cylinder (60mm)	4940	4		
	With Coin and Knob Cylinder (60mm)	4875	4		
	With Both Side Key Cylinder (70mm)	4940	4		
	With Knob and Key Cylinder (70mm)	5000	4		
	With Coin and Knob Cylinder (70mm)	4940	4		

Latch Sets ML Series (On Rose) Combo Set	Description	Finish Available		Std. Pkg.
		GMHG	CBGM / MRGM GMWD	
Kaira-X	With Mortise Latch	2475	2260	4
Amoli	With Mortise Latch		2260	4

Latch Sets ML Series (On Rose) Combo Set	Description	Finish Available		Std. Pkg.
		SS/SC/ PT	WD	
Zovi Kaira Odiun Texa	With Mortise Latch	1850	1900	4
Hale Dash	With Mortise Latch	2065		4
Deolo	With Mortise Latch	2190		4
Zara	With Mortise Latch	2370		4
Ceto Elina	With Mortise Latch	2370		4
Dave Onix	With Mortise Latch	2445		4
Stella Cosmo Noha	With Mortise Latch	2650		4

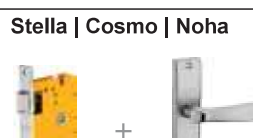





Lock Sets With Lock Body & Without Cylinder HL Combo Set			Finish Available		Std. Pkg.
			GMHG	CBGM / MRGM GMWD	
HL Series (8" on Plate)	Kaira-X Amoli  +  		2645	2540	4
	HL KAI W/O CL (GMHG GMWD) HL AML W/O CL (CBGM MRGM)				



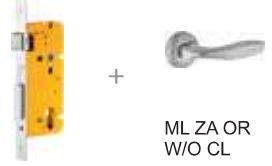

Lock Sets With Lock Body & Without Cylinder HL Combo Set			Finish Available		Std. Pkg.
			SS/ SC/ PT	WD	
HL Series (8" on Plate)	Zovi Kaira Odiun Texa  +   		2295	2360	4
	HL ZOV W/O CL HL KAI W/O CL HL ODI W/O CL HL TEX W/O CL				
HL Series (8" on Plate)	Hale Dash  + 		2870		4
	HL HALE W/O CL HL DAS W/O CL				
HL Series (8" on Plate)	Deolo  + 		3225		4
	HL DEO W/O CL				
HL Series (8" on Plate)	Zara  + 		3370		4
	HL ZA W/O CL				
HL Series (8" on Plate)	Ceto Elina  + 		3540		4
	HL CO W/O CL HL ELN W/O CL				
HL Series (8" on Plate)	Dave Onix  + 		3740		4
	HL DAV W/O CL HL ON W/O CL				
HL Series (8" on Plate)	Stella Cosmo Noha  +  		3800		4
	HL ST W/O CL HL CS W/O CL HL NO W/O CL				

Lock Sets With Lock Body & Without Cylinder ML Combo Set			Finish Available		Std. Pkg.
			GMHG	CBGM / MRGM GMWD	
ML Series (10" on Plate)	Kaira-X Amoli  +  ML KAI W/O CL (GMHG GMWD) ML AML W/O CL (CBGM MRGM)		3080	2980	4

Lock Sets With Lock Body & Without Cylinder ML Combo Set			Finish Available		Std. Pkg.
			SS/ SC/ PT	WD	
ML Series (10" on Plate)	Zovi Kaira Odiun Texa  +     ML ZOV W/O CL ML KAI W/O CL ML ODI W/O CL ML TEX W/O CL		2715	2775	4
	ML Series (10" on Plate)	Hale Dash  +  ML HALE W/O CL ML DAS W/O CL		3300	
ML Series (10" on Plate)		Deolo  +  ML DEO W/O CL		3740	
	ML Series (10" on Plate)	Zara  +  ML ZA W/O CL		3890	
ML Series (10" on Plate)		Ceto Elina  +  ML CO W/O CL ML ELN W/O CL		4110	
	ML Series (10" on Plate)	Dave Onix  +  ML DAV W/O CL ML ON W/O CL		4205	
ML Series (10" on Plate)		Stella Cosmo Noha  +    ML ST W/O CL ML CS W/O CL ML NO W/O CL		4320	

Lock Sets With Lock Body & Without Cylinder ML Combo Set (on Rose)			Finish Available		Std. Pkg.
			GMHG	CBGM / MRGM GMWD	
ML Series (On Rose)	Kaira-X Amoli 		3205	3105	4
	ML KAI OR W/O CL (GMHG GMWD)	ML AML OR W/O CL (CBGM MRGM)			

			Finish Available		Std. Pkg.
			SS/ SC/ PT	WD	
ML Series (On Rose)	Zovi Kaira Odiun Texa 		2870	2930	4
	ML ZOV OR W/O CL	ML KAI OR W/O CL			
ML Series (On Rose)	Hale Dash 		3465		4
	ML HALE OR W/O CL	ML DAS OR W/O CL			
ML Series (On Rose)	Deolo 		3880		4
	ML DEO OR W/O CL				
ML Series (On Rose)	Zara 		4320		4
	ML ZA OR W/O CL				
ML Series (On Rose)	Ceto Elina 		4320		4
	ML CO OR W/O CL	ML ELN OR W/O CL			
ML Series (On Rose)	Dave Onix 		4375		4
	ML DAV OR W/O CL	ML ON OR W/O CL			
ML Series (On Rose)	Stella Cosmo Noha 		4465		4
	ML ST OR W/O CL	ML CS OR W/O CL			

Lock Sets Brass HL 8" Combo Set		Description	Finish Available			Std. Pkg.
			Brass	SS	PT	
HL Series (8" on Plate)	Diva 	With Both Side Key Cylinder (60mm)	4600	4600	4600	4
	HL 170 	With Knob and Key Cylinder (60mm)	4665	4665	4665	4
		With Coin and Knob Cylinder (60mm)	4600	4600	4600	4
HL Series (8" on Plate)	Biva 	With Mortise Lock	3350	3350	3350	4

Latch Sets Brass HL 8" Combo Set		Description	Finish Available			Std. Pkg.
			Brass	SS	PT	
Diva		With Mortise Latch	3800	3800	3800	4
Biva		With Mortise Latch	3235	3235	3235	4

Lock Sets With Lock Body & Without Cylinder Brass		Finish Available			Std. Pkg.
		Brass	SS	PT	
HL Series (8" on Plate)	Diva 				4
HL 170 W/O CL		4125	4125	4125	

Lock Sets SS HL 8" Combo Set		Description	Finish Available		Std. Pkg.
			SS		
HL Series (8" on Plate)	Eden Primo	With Both Side Key Cylinder (60mm)	3940		4
		With Knob and Key Cylinder (60mm)	4000		4
	HL ED	With Coin and Knob Cylinder (60mm)	3940		4
	HL PR	With Both Side Key Cylinder (70mm)	4250		4
		With Knob and Key Cylinder (70mm)	4320		4
		With Coin & Knob Cylinder (70mm)	4250		4

Latch Sets SS HL 8" Combo Set	Description	Finish Available		Std. Pkg.
		SS		
Eden I Primo	With Mortise Latch	3135		4



Lock Sets SS ML 10" Combo Set	Description	Finish Available		Std. Pkg.
		SS		
ML Series (10" on Plate) 	Eden I Primo			
	With Both Side Key Cylinder (60mm)	4320		4
	With Knob and Key Cylinder (60mm)	4375		4
	With Coin and Knob Cylinder (60mm)	4320		4
	With Both Side Key Cylinder (70mm)	4620		4
	With Knob and Key Cylinder (70mm)	4690		4
With Coin and Knob Cylinder (70mm)	4620		4	



Lock Sets SS ML On Rose Combo Set	Description	Finish Available		Std. Pkg.
		SS		
ML Series (On Rose) 	Eden I Primo			
	With Both Side Key Cylinder (60mm)	4320		4
	With Knob and Key Cylinder (60mm)	4375		4
	With Coin and Knob Cylinder (60mm)	4320		4
	With Both Side Key Cylinder (70mm)	4620		4
	With Knob and Key Cylinder (70mm)	4690		4
With Coin and Knob Cylinder (70mm)	4620		4	



Latch Sets SS ML On Rose Combo Set	Description	Finish Available		Std. Pkg.
		SS		
Eden I Primo	With Mortise Latch	3135		4



Lock Sets SS ML On Rose Combo Set	Description	SS		Std. Pkg.	
		19mm dia	22mm dia		
ML Series (On Rose) 	With Both Side Key Cylinder (60mm)	3205	3245	4	
	With Knob and Key Cylinder (60mm)	3265	3320	4	
			SS		Std. Pkg.
	With Both Side Key Cylinder (60mm)	3775		4	
	With Knob and Key Cylinder (60mm)	3840		4	

Lock Sets With Lock Body & Without Cylinder SS			Finish Available		Std. Pkg.	
			SS			
HL Series (8" on Plate)	 ML 170	Eden Primo +  HL ED W/O CL	 HL PR W/O CL	3500		4

Lock Sets With Lock Body & Without Cylinder SS			Finish Available		Std. Pkg.	
			SS			
ML Series (10" on Plate)	 ML 110 SS	Eden Primo +  ML ED W/O CL	 ML PR W/O CL	3880		4







Lock Sets With Lock Body & Without Cylinder SS			Finish Available		Std. Pkg.	
			SS			
ML Series (On Rose)	 ML 171	Eden Primo +  ML ED OR W/O CL	 ML PR OR W/O CL	3880		4

Lock Sets SS ML On Rose Combo Set (without cylinder)			SS		Std. Pkg.	
			19mm dia	22mm dia		
ML Series (On Rose)	 ML 171	'D' Type 'L' Type +  ML SD OR W/O CL	 ML SL OR W/O CL	2775	2830	4

Lock Sets SS ML On Rose Combo Set (without cylinder)			Finish Available		Std. Pkg.	
			SS			
ML Series (On Rose)	 ML 171	SLP SEP +  ML SLP OR W/O CL	 ML SEP OR W/O CL	2775		4

Door Closers		Description	Weight	MRP	Std. Pkg.
FR 120	 Fire Rated Upto 2 Hours	Door Closer	120 Kg	6380	10
FR 80	 Fire Rated Upto 2 Hours	Door Closer	80 Kg	3220	10
FR 60	 Fire Rated Upto 2 Hours	Door Closer	60 Kg	2555	10
DC 80 Ext. (WP) GM		Door Closer	80 Kg	4965	6
DC 80 Ext. (WP) ANTIQUE		Door Closer Ext Antique	80 Kg	4965	6
DC 80 Ext. (WP) SS		Door Closer Ext With Palmet Arm in SS finish	80 Kg	4965	6
DC 80 Ext. (WP) PAINT		Door Closer Ext With Palmet Arm	80 Kg	3680	6
DC 80 Ext		Door Closer Ext	80 Kg	3405	8
DC 80 PDC		Door Closer PDC	80 Kg	2845	8
DC 80 PDC (WP)		Door Closer PDC With Palmet Arm	80 Kg	3095	8
DC 85 CO		Concealed Door Closer	60 to 85 Kg	6245	4
DC 65 CO		Concealed Door Closer	40 to 65 Kg	5905	4
DC 40 CO		Concealed Door Closer	40 Kg	5525	10
DC 40 SM		Door Closer	40 Kg	1500	6
DC 60 SM		Door Closer	60 Kg	1745	6
DC 60 GM		Door Closer	60 Kg	1950	6

Floor Spring		Description	Weight	MRP	Std. Pkg.
FS 100		Floor Spring (without BP/TP)	65-100 Kg	6635	2
FS 120		Floor Spring (without BP/TP)	100-120 Kg	6890	2
FS 150		Floor Spring (without BP/TP)	120-150 Kg	7415	2
FS 7070		Floor Spring (without BP/TP)	Upto 70 Kg	4000	4
FS 6080		Floor Spring (without BP/TP)	Upto 90 Kg	4965	2
FS 6120		Floor Spring (without BP/TP)	Upto 120 Kg	5465	2
FS TP/BP		Top - Bottom Pivot Suitable for Wooden Door/ Aluminum Door		825	2

Glass Combo Set		Description	Weight	SS	GM
CS 70 WL		Glass Combo Set With Lock Patch, Top & Bottom Patch Fittings	Upto 70 Kg	7655	10085
CS 70		Glass Combo Set With Top & Bottom Patch Fittings (Without Lock Patch)	Upto 70 Kg	5500	8495
CS 80 WL		Glass Combo Set With Lock Patch, Top & Bottom Patch Fittings	Upto 80 Kg	8475	12740
CS 80		Glass Combo Set With Top & Bottom Patch Fittings (Without Lock Patch)	Upto 80 Kg	6320	10615
CS 100 WL		Glass Combo Set With Lock Patch, Top & Bottom Patch Fittings	Upto 100 Kg	11520	14860
CS 100		Glass Combo Set With Top & Bottom Patch Fittings (Without Lock Patch)	Upto 100 Kg	9345	13270

Door Weight Calculation Chart for Door Closer & Floor Spring

Glass Door Weight			
Size			Weight (Kg)
Width (ft)	Height (ft)	Thickness (mm)	
2.5	7	6	24.3
2.5	8	6	27.8
3	7	6	29.1
3	8	6	33.3
3.5	7	6	34.0
4	8	6	44.4
4.5	7	6	43.7
4.5	8	6	50.0
5	7	6	48.6
5	8	6	55.5

2.5	7	8	32.4
2.5	8	8	37.0
3	7	8	38.9
3	8	8	44.4
3.5	7	8	45.3
4	8	8	59.2
4.5	7	8	58.3
4.5	8	8	66.6
5	7	8	64.8
5	8	8	74.0

2.5	7	12	48.6
2.5	8	12	55.5
3	7	12	58.3
3	8	12	66.6
3.5	7	12	68.0
4	8	12	88.8
4.5	7	12	87.4
4.5	8	12	99.9
5	7	12	97.2
5	8	12	111.0

Indian Teak Door Weight				
Size			Material Density (FOS)	Weight (Kg)
Width (ft)	Height (ft)	Thickness (mm)		
2.5	7	36.1	1.25	27.1
2.5	8	41.3	1.25	31.0
3	7	43.4	1.25	32.5
3	8	49.6	1.25	37.2
3.5	7	50.6	1.25	37.9
4	8	66.1	1.25	49.6
4.5	7	65.0	1.25	48.8
4.5	8	74.3	1.25	55.7
5	7	72.3	1.25	54.2
5	8	82.6	1.25	61.9

Indian Teak Door Weight				
Size			Material Density (FOS)	Weight (Kg)
Width (ft)	Height (ft)	Thickness (mm)		
2.5	7	43.4	1.5	32.5
2.5	8	49.6	1.5	37.2
3	7	52.0	1.5	39.0
3	8	59.5	1.5	44.6
3.5	7	60.7	1.5	45.5
4	8	79.3	1.5	59.5
4.5	7	78.0	1.5	58.5
4.5	8	89.2	1.5	66.9
5	7	86.7	1.5	65.0
5	8	99.1	1.5	74.3

2.5	7	50.6	1.75	37.9
2.5	8	57.8	1.75	43.4
3	7	60.7	1.75	45.5
3	8	69.4	1.75	52.0
3.5	7	70.8	1.75	53.1
4	8	92.5	1.75	69.4
4.5	7	91.1	1.75	68.3
4.5	8	104.1	1.75	78.0
5	7	101.2	1.75	75.9
5	8	115.6	1.75	86.7

2.5	7	57.8	2	43.4
2.5	8	66.1	2	49.6
3	7	69.4	2	52.0
3	8	79.3	2	59.5
3.5	7	80.9	2	60.7
4	8	105.7	2	79.3
4.5	7	104.1	2	78.0
4.5	8	118.9	2	89.2
5	7	115.6	2	86.7
5	8	132.1	2	99.1

Note:

1. For Selection of Floor Spring for glass door factor of safety should be taken as 1.
2. For Selection of Door closers for wooden door factor of safety should be taken as 1.

SS 2 Ball Bearing Hinge (with screw)	Size	Code	Finish	Std. Pkg.
			SS	
	76 X 64 X 2MM	HG 1150	215	40
	102 X 76 X 2.5MM	HG 1151	290	40
	127 X 76 X 2.5MM	HG 1152	310	40
	102 X 76 X 3MM	HG 1153	330	40
	127 X 76 X 3MM	HG 1154	370	40

SS 2 Ball Bearing Hinge (with screw)	Size	Code	Finish	Std. Pkg.
			SS	
SS Grade 304 Upto 2 Hour Fire Rated	102 X 76 X 2.5MM	HG 1151 A	355	40
	127 X 76 X 2.5MM	HG 1152 A	390	40
	102 X 76 X 3MM	HG 1153 A	400	40
	127 X 76 X 3MM	HG 1154 A	480	40

SS Pin Type Welded Hinge (without screw)	Size	Code	Finish	Std. Pkg.
			SS	
	75x48x1.7MM	HG5150SS	65	60
	75x48x2.5MM	HG5150HSS	105	60
	100x58x1.9MM	HG5151SS	120	60
	100x61x2.5MM	HG5151HSS	155	60
	125x64x1.9MM	HG5152SS	165	60
	125x65x2.5MM	HG5152HSS	205	60

SS 2 Ball Bearing Hinge (with screw)	Size	Code	Finish	Std. Pkg.
			SS	
SS Grade 304 	127 X 76 X 2.5MM	HGRC 1152 A	590	40
	102 X 76 X 3MM	HGRC 1153 A	550	40

SS Pin Type Round Corner Hinge (Without Screw)	Size	Code	Finish	Std. Pkg.
			SS	
	127 X 76 X 2.5MM	HGRC6051SS	255	40

For Steel Door	SS 2 Ball Bearing Hinge (with screw)	Size	Code	Finish	Std. Pkg.
				SS	
 Fire Rated Upto 2 Hours		102x76x3mm	HG 1253	515	40
				40	

SS Flush Hinge (With Screw)	Size	Code	Finish
			SS
	100x37x2.5 MM (SS 304)	BHG6150A SS	345
	100x37x2.5 MM	BHG6150SS SM	275



Brass Tower Bolt (with screw)	Description	Finish	
		EP	SS/PT
Round Dia - 10mm 	TR 310 - 03"	335	395
	TR 410 - 04"	540	595
	TR 610 - 06"	690	730
	TR 810 - 08"	835	875
	TR 1010 - 10"	1015	1055
	TR 1210 - 12"	1200	1255



SS Tower Bolt (with screw)	Description	Finish	Std. Pkg.
		SS	
Square Shape, Dia - 10mm 	TS-410 - 04"	155	60
	TS-610 - 06"	225	60
	TS-810 - 08"	275	60
	TS-1010 - 10"	345	60
	TS-1210 - 12"	410	60
	TS-1810 - 18"	655	60

Door Accessories	Size	Code	Finish		Std. Pkg.
			NI	PT	
Kadi Tala 	200 MM	KDT 200	1055	1235	10
	275 MM	KDT 275	1170	1335	10

Door Accessories		Size	Code	Finish SS/PT	Std. Pkg.
ALDROP		200X16 MM	ALDSM (200X16)	565	10
		250X16 MM	ALDSM (250X16)	605	10
		300X16 MM	ALDSM (300X16)	755	10
TADI		200X12 MM	SDH-TDH20012-304	505	10
		250X12 MM	SDH-TDH25012-304	565	10
		300X12 MM	SDH-TDH30012-304	655	10

Door Accessories	Description	MRP
ME (B)	 Magic Eye Big (Brass)	455
MEF (S)	 Magic Eye Small with Flap (Brass)	380
DGBT	 Door Guard Buckel Type (Brass)	870
DS HR (SS)	 Door Stopper Floor Mounted Half Round (SS 304)	365
DS HR (Z)	 Door Stopper Floor Mounted Half Round (Zamak)	210
DB WC (22)	 Door Buffer- Wall Mounted Dia 22mm Ht. 75mm with Cover (Stainless Steel)	285
DB (22)	 Door Buffer- Wall Mounted Dia 22mm Ht. 75mm without Cover (Stainless Steel)	245
DS HT	 Door Stopper- Door Mounted Hanging Type (Brass)	395
DS HT (Z)	 Door Stopper- Door Mounted Hanging Type (Zamak)	340
MDS-CL MDS-GM	 Concealed Door Stopper (MAGNETO)	820

Door Accessories	Description	MRP
DSC (M)	 Door Safety Chain- Manually (Brass & Stainless Steel)	515
BL (S)	 Sliding Bolt (Baby Latch) with Stainless Steel Lock Strip 03" (Body in Zinc)	225
BL (B)	 Sliding Bolt (Baby Latch) with SS Lock Strip 05"	365
IB 390	 Indicator Bolt	670
DDDL	 Double Door Attachment- For Dead Lock (Brass) - SS Finish	650
DDML	 Double Door Attachment- For Mortise Lock (Brass) - SS Finish	950
DDML (ML170)	 Double Door Attachment - For ML170 (Brass) - SS Finish	950
DBPVC-W	 Door Buffer 03" PVC White	50
DBRB-B	 Door Buffer 03" Rubber Black	50
MDC SS304	 Magnetic Door Catcher	500

Code	Straight Patch Fittings	Description	MRP
DPF-320		Top Pivot	315
DPF-321		Top Patch	1815
DPF-322		Bottom Patch	1815
DPF-325		Center Patch Lock with Cylinder	3270

All Available in-PSS: Polished

TERMS & CONDITIONS

Product prices are subject to change without prior notice.

● Ordering Procedure

- * Order booking should be in multiples of standard packing wherever it is applicable.
- * Orders to be placed as per the guidelines of the company.
- * Orders should be placed in writing only
- * Discount may vary from product to product. Refer the price list.

● Title and Risk for Goods

- * Risk and Title in the Goods shall pass to the Purchaser upon the sooner of happening of the delivery to the delivery destination or upon the loading of the Goods on a third party vehicle or the Purchaser's vehicle for delivery to the delivery destination.
- * Notwithstanding the above, the Company possess the lien on the Goods sold to the Purchaser until the Company receives payment in full for all Goods and for all money owing by the Purchaser to the company on any account whatsoever. The Company will have the right to recover the money due by selling the said goods to the third party or by taking back the goods to the Company premises as the circumstances prevail.

● Return guidelines for the damaged / short supplied goods.

- * Any damaged or short material received must be immediately notified and any discrepancy must be clearly mentioned on pod/delivery receipt.
- * No claim will be entertained in case discrepancy is not notified in writing immediately.
- * No material for return shall be accepted by the company, in case valid claim is not filed in writing within 1 months of the date of invoice.
- * All original packing material to be returned.
- * All manuals and warranty registration cards must be unmarked. Upon receipt of return in accordance with the above terms, we shall issue a credit note.

All disputes are subject to Delhi Court.

Price list version - 2020/21

OUR PRODUCT CODING SYSTEM

coding | LEVER HANDLES

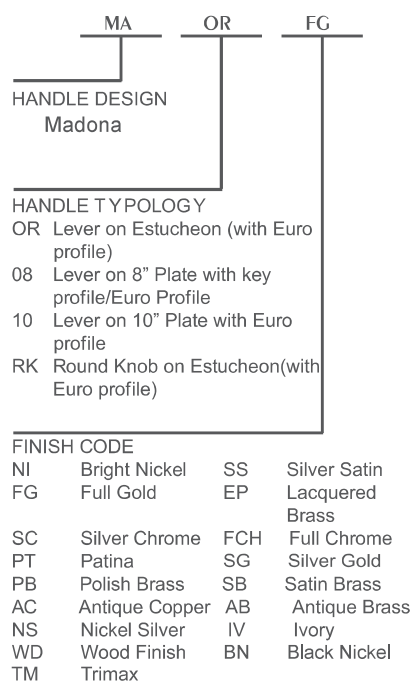

coding | PULL HANDLES

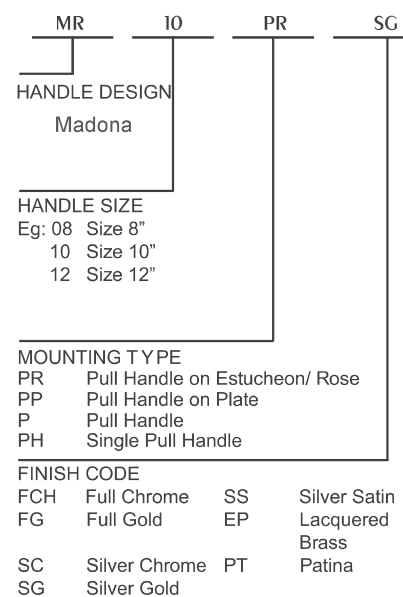

coding | EURO PROFILE CYLINDERS

Euro Profile Brass Cylinder (both side key)	60mm	70mm	80mm	90mm	100mm
Euro Profile Brass Cylinder (one side knob & one side key)	CL 200	CL 206	CL 203	CL 214	CL 211
Euro Profile Brass Cylinder (one side knob & one side emergency opening)	CL 201	CL 207	CL 204	CL 215	CL 212
	CL 202	CL 208	CL 205	CL 216	CL 213

Master key & Grand Master key available on request.

Finishes - Bright Nickel (NI), Silver Satin (SS),

Patina (PT), Full Gold (FG), Lacquered Brass (EP).

FURNITURE FITTINGS & KITCHEN HARDWARE

dorsët
we understand

HINGE SYSTEM

 GEN

BALL BEARING SLIDE SYSTEM

 SLIDE

SOFT CLOSE BALL BEARING
SLIDE SYSTEM

 MOVE

UNDERMOUNT SLIDE SYSTEM

 TRAX

GAS PISTON

 LIFT

DRAWER SYSTEM

 BOX





dorsët
we understand



HINGE SYSTEM







iGen Soft Close Hinge comes with advanced soft close mechanism ensuring silent closing of doors along with high end design and functionality.



iGen Soft Close Hinge is designed with advanced technology and produced using a fully automated robotic production system together with new Generation Methods.

Slide On Hinge		Code	Description	Unit	MRP	Package Content
		IG0C	Slide on Hinge 0 crank with mounting plate	Pair	88.00	50 Set
		IG9C	Slide on Hinge 9 crank with mounting plate	Pair	93.00	50 Set
		IG18C	Slide on Hinge 18 crank with mounting plate	Pair	98.00	50 Set

Soft Close Slide On Hinge		Code	Description	Unit	MRP	Package Content
		IGSOSC0C	Soft Close Slide On Hinge 0 crank with 4 Hole mounting plate	Pair	188.00	50 Set
		IGSOSC9C	Soft Close Slide On Hinge 9 crank with 4 Hole mounting plate	Pair	198.00	50 Set
		IGSOSC18C	Soft Close Slide On Hinge 18 crank with 4 Hole mounting plate	Pair	204.00	50 Set

Soft Close Hinge with 4 Hole Mounting Plate		Code	Description	Unit	MRP	Package Content
		IGSC0C	Soft Close Clip On Hinge 0 crank with 4 Hole mounting plate	Pair	265.00	50 Set
		IGSC9C	Soft Close Clip On Hinge 9 crank with 4 Hole mounting plate	Pair	279.00	50 Set
		IGSC18C	Soft Close Clip On Hinge 18 crank with 4 Hole mounting plate	Pair	293.00	50 Set

Soft Close 3D Adjustable Hinge		Code	Description	Unit	MRP	Package Content
		IGSC3D0C	Soft Close Clip On Hinge 0 crank with 3D mounting plate	Pair	350.00	50 Set
		IGSC3D9C	Soft Close Clip On Hinge 9 crank with 3D mounting plate	Pair	372.00	50 Set
		IGSC3D18C	Soft Close Clip On Hinge 18 crank with 3D mounting plate	Pair	395.00	50 Set

Soft Close SS 304 Hinge		Code	Description	Unit	MRP	Package Content
		IGSCSS0C	Soft Close Clip On Hinge 0 crank SS 304 Hinge with mounting plate	Pair	496.00	50 Set
		IGSCSS9C	Soft Close Clip On Hinge 9 crank SS 304 Hinge with mounting plate	Pair	520.00	50 Set
		IGSCSS18C	Soft Close Clip On Hinge 18 crank SS 304 Hinge with mounting plate	Pair	547.00	50 Set

3D HINGE







Blind Corner 90° Hinge		Code	Description	Unit	MRP	Package Content
iGEN		IGBLDCR90	Blind Corner 90 Degree Hinge with Mounting Plate	Pair	408.00	30 Set
		IGBLDCRSC90	Blind Corner 90 Degree Soft Close Hinge with Mounting Plate	Pair	817.00	30 Set

Pi Corner 165° Hinge		Code	Description	Unit	MRP	Package Content
iGEN		IGPICR165	Pi Corner 165 Degree Hinge with Mounting Plate	Pair	592.00	30 Set
		IGPICRSC165	Pi Corner 165 Degree Soft Close Hinge with Mounting Plate	Pair	1041.00	30 Set

Bi-fold Hinge		Code	Description	Unit	MRP	Package Content
iGEN		IGBFH	Bi - Fold Hinge with Mounting Plate	Pair	572.00	30 Set

Thick Door Hinge		Code	Description	Unit	MRP	Package Content
iGEN		IGTD0C	Thick Door Hinge 0 Crank with Mounting Plate	Pair	260.00	30 Set
		IGTD9C	Thick Door Hinge 9 Crank with Mounting Plate	Pair	271.00	30 Set
		IGTD18C	Thick Door Hinge 18 Crank with Mounting Plate	Pair	281.00	30 Set

Thick Door Soft Close Hinge		Code	Description	Unit	MRP	Package Content
iGEN		IGSCTD0C	Thick Door Soft Close Hinge 0 Crank with Mounting Plate	Pair	408.00	30 Set
		IGSCTD9C	Thick Door Soft Close Hinge 9 Crank with Mounting Plate	Pair	419.00	30 Set
		IGSCTD18C	Thick Door Soft Close Hinge 18 Crank with Mounting Plate	Pair	429.00	30 Set

dorsët
we understand

 **SLIDE**

BALL BEARING SLIDE SYSTEM

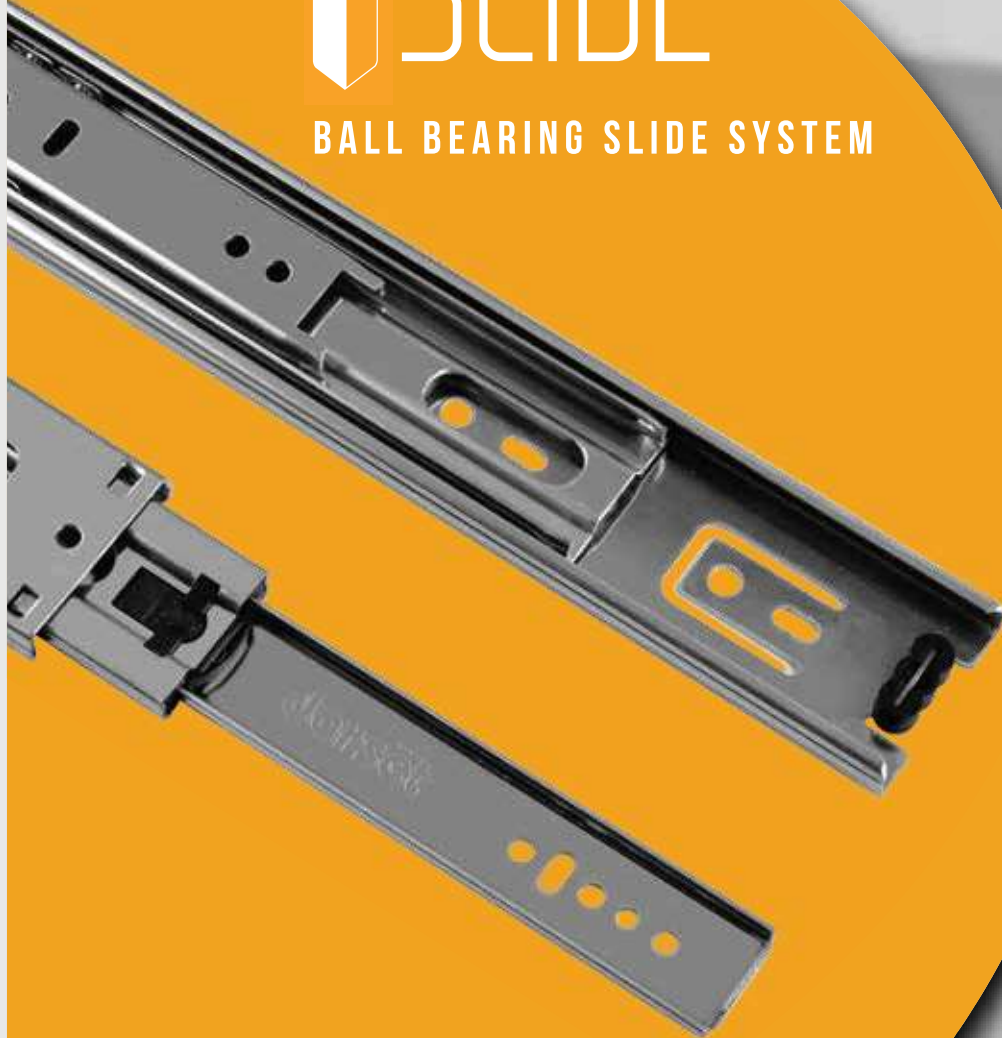



Ball Bearing Full Extension Slide 46mm Zinc (45 Kg)		Code	Description	Unit	MRP	Package Content
 <p>SLIDE</p>	ISBB250	I Slide Ball Bearing Slide Zinc 46 - 250 mm	Pair	364.00	10 Set	
	ISBB300	I Slide Ball Bearing Slide Zinc 46 - 300 mm	Pair	393.00	10 Set	
	ISBB350	I Slide Ball Bearing Slide Zinc 46 - 350 mm	Pair	432.00	10 Set	
	ISBB400	I Slide Ball Bearing Slide Zinc 46 - 400 mm	Pair	454.00	10 Set	
	ISBB450	I Slide Ball Bearing Slide Zinc 46 - 450 mm	Pair	500.00	10 Set	
	ISBB500	I Slide Ball Bearing Slide Zinc 46 - 500 mm	Pair	517.00	10 Set	
	ISBB550	I Slide Ball Bearing Slide Zinc 46 - 550 mm	Pair	570.00	10 Set	
	ISBB600	I Slide Ball Bearing Slide Zinc 46 - 600 mm	Pair	610.00	10 Set	

Ball Bearing Full Extension Slide 46mm Black (45 Kg)		Code	Description	Unit	MRP	Package Content
 <p>SLIDE</p>	ISBB250BL	I Slide Ball Bearing Slide Black 46 - 250 mm	Pair	364.00	10 Set	
	ISBB300BL	I Slide Ball Bearing Slide Black 46 - 300 mm	Pair	393.00	10 Set	
	ISBB350BL	I Slide Ball Bearing Slide Black 46 - 350 mm	Pair	432.00	10 Set	
	ISBB400BL	I Slide Ball Bearing Slide Black 46 - 400 mm	Pair	454.00	10 Set	
	ISBB450BL	I Slide Ball Bearing Slide Black 46 - 450 mm	Pair	500.00	10 Set	
	ISBB500BL	I Slide Ball Bearing Slide Black 46 - 500 mm	Pair	517.00	10 Set	
	ISBB550BL	I Slide Ball Bearing Slide Black 46 - 550 mm	Pair	570.00	10 Set	
	ISBB600BL	I Slide Ball Bearing Slide Black 46 - 600 mm	Pair	610.00	10 Set	



Ball Bearing Full Extension Soft Close Slide 46mm Zinc (30 Kg)		Code	Description	Unit	MRP	Package Content
 		IMBB300SC	I Move Soft close Ball Bearing Slide Zinc 46 - 300 mm	Pair	858.00	10 Set
		IMBB350SC	I Move Soft close Ball Bearing Slide Zinc 46 - 350 mm	Pair	879.00	10 Set
		IMBB400SC	I Move Soft close Ball Bearing Slide Zinc 46 - 400 mm	Pair	902.00	10 Set
		IMBB450SC	I Move Soft close Ball Bearing Slide Zinc 46 - 450 mm	Pair	930.00	10 Set
		IMBB500SC	I Move Soft close Ball Bearing Slide Zinc 46 - 500 mm	Pair	956.00	10 Set
		IMBB550SC	I Move Soft close Ball Bearing Slide Zinc 46 - 550 mm	Pair	988.00	10 Set
		IMBB600SC	I Move Soft close Ball Bearing Slide Zinc 46 - 600 mm	Pair	1140.00	10 Set

Ball Bearing Full Extension Soft Close Slide 46mm Black (30 Kg)		Code	Description	Unit	MRP	Package Content
 		IMBB300SCBL	I Move Soft close Ball Bearing Slide Black 46 - 300 mm	Pair	858.00	10 Set
		IMBB350SCBL	I Move Soft close Ball Bearing Slide Black 46 - 350 mm	Pair	879.00	10 Set
		IMBB400SCBL	I Move Soft close Ball Bearing Slide Black 46 - 400 mm	Pair	902.00	10 Set
		IMBB450SCBL	I Move Soft close Ball Bearing Slide Black 46 - 450 mm	Pair	930.00	10 Set
		IMBB500SCBL	I Move Soft close Ball Bearing Slide Black 46 - 500 mm	Pair	956.00	10 Set
		IMBB550SCBL	I Move Soft close Ball Bearing Slide Black 46 - 550 mm	Pair	988.00	10 Set
		IMBB600SCBL	I Move Soft close Ball Bearing Slide Black 46 - 600 mm	Pair	1140.00	10 Set





UNDER MOUNT SLIDE SYSTEM



Undermount Slide System W 40Kg		Code	Description	Unit	MRP	Package Content
ITRAX		ITRAX300	I Trax Undermount Slide 300 mm	Pair	1869.00	6 Set
		ITRAX350	I Trax Undermount Slide 350 mm	Pair	1869.00	6 Set
		ITRAX400	I Trax Undermount Slide 400 mm	Pair	1869.00	6 Set
		ITRAX450	I Trax Undermount Slide 450 mm	Pair	1930.00	6 Set
		ITRAX500	I Trax Undermount Slide 500 mm	Pair	2032.00	6 Set
		ITRAX550	I Trax Undermount Slide 550 mm	Pair	2235.00	6 Set









Gas Piston		Code	Description	Unit	MRP	Package Content
LIFT		IL60N	Gas piston Lift up 60N	Pair	285.00	25 Set
		IL80N	Gas piston Lift up 80N	Pair	285.00	25 Set
		IL100N	Gas piston Lift up 100N	Pair	285.00	25 Set
		IL120N	Gas piston Lift up 120N	Pair	285.00	25 Set
		IL150N	Gas piston Lift up 150N	Pair	285.00	25 Set
		IL200N	Gas piston Lift up 200N	Pair	310.00	25 Set
		IL250N	Gas piston Lift up 250N	Pair	310.00	25 Set



BOX
DRAWER SYSTEM



dorsët
we understand



Drawer System H 89mm : W 40Kg		Code	Description	Unit	MRP	Package Content
i BOX		IBOX350GR89	I Box 350 mm Grey Height 89 mm	Set	3150.00	4 Set
		IBOX400GR89	I Box 400 mm Grey Height 89 mm	Set	3150.00	4 Set
		IBOX450GR89	I Box 450 mm Grey Height 89 mm	Set	3150.00	4 Set
		IBOX500GR89	I Box 500 mm Grey Height 89 mm	Set	3150.00	4 Set
		IBOX550GR89	I Box 550 mm Grey Height 89 mm	Set	3150.00	4 Set
		IBOX350AN89	I Box 350 mm Anthracite Height 89 mm	Set	3150.00	4 Set
		IBOX400AN89	I Box 400 mm Anthracite Height 89 mm	Set	3150.00	4 Set
		IBOX450AN89	I Box 450 mm Anthracite Height 89 mm	Set	3150.00	4 Set
		IBOX500AN89	I Box 500 mm Anthracite Height 89 mm	Set	3150.00	4 Set
		IBOX550AN89	I Box 550 mm Anthracite Height 89 mm	Set	3150.00	4 Set
		IBOX350MO89	I Box 350 mm Mocha Height 89 mm	Set	3203.00	4 Set
		IBOX400MO89	I Box 400 mm Mocha Height 89 mm	Set	3203.00	4 Set
		IBOX450MO89	I Box 450 mm Mocha Height 89 mm	Set	3203.00	4 Set
		IBOX500MO89	I Box 500 mm Mocha Height 89 mm	Set	3203.00	4 Set
		IBOX550MO89	I Box 550 mm Mocha Height 89 mm	Set	3203.00	4 Set

Drawer System H 127mm : W 40Kg		Code	Description	Unit	MRP	Package Content
i BOX		IBOX400GR127	I Box 400 mm Grey Height 127 mm	Set	3704.00	4 Set
		IBOX450GR127	I Box 450 mm Grey Height 127 mm	Set	3704.00	4 Set
		IBOX500GR127	I Box 500 mm Grey Height 127 mm	Set	3704.00	4 Set
		IBOX550GR127	I Box 550 mm Grey Height 127 mm	Set	3704.00	4 Set
		IBOX400AN127	I Box 400 mm Anthracite Height 127 mm	Set	3704.00	4 Set
		IBOX450AN127	I Box 450 mm Anthracite Height 127 mm	Set	3704.00	4 Set
		IBOX500AN127	I Box 500 mm Anthracite Height 127 mm	Set	3704.00	4 Set
		IBOX550AN127	I Box 550 mm Anthracite Height 127 mm	Set	3704.00	4 Set
		IBOX400MO127	I Box 400 mm Mocha Height 127 mm	Set	3804.00	4 Set
		IBOX450MO127	I Box 450 mm Mocha Height 127 mm	Set	3804.00	4 Set
		IBOX500MO127	I Box 500 mm Mocha Height 127 mm	Set	3804.00	4 Set
		IBOX550MO127	I Box 550 mm Mocha Height 127 mm	Set	3804.00	4 Set



Drawer System H 174mm : W 40Kg		Code	Description	Unit	MRP	Package Content
iBOX		IBOX400GR174	I Box 400 mm Grey Height 174 mm	Set	4304.00	4 Set
		IBOX450GR174	I Box 450 mm Grey Height 174 mm	Set	4304.00	4 Set
		IBOX500GR174	I Box 500 mm Grey Height 174 mm	Set	4304.00	4 Set
		IBOX550GR174	I Box 550 mm Grey Height 174 mm	Set	4304.00	4 Set
		IBOX400AN174	I Box 400 mm Anthracite Height 174 mm	Set	4304.00	4 Set
		IBOX450AN174	I Box 450 mm Anthracite Height 174 mm	Set	4304.00	4 Set
		IBOX500AN174	I Box 500 mm Anthracite Height 174 mm	Set	4304.00	4 Set
		IBOX550AN174	I Box 550 mm Anthracite Height 174 mm	Set	4304.00	4 Set
		IBOX400MO174	I Box 400 mm Mocha Height 174 mm	Set	4404.00	4 Set
		IBOX450MO174	I Box 450 mm Mocha Height 174 mm	Set	4404.00	4 Set
		IBOX500MO174	I Box 500 mm Mocha Height 174 mm	Set	4404.00	4 Set
		IBOX550MO174	I Box 550 mm Mocha Height 174 mm	Set	4404.00	4 Set



Drawer System H 206mm : W 40Kg		Code	Description	Unit	MRP	Package Content
iBOX		IBOX400GR206	I Box 400 mm Grey Height 206 mm	Set	4755.00	4 Set
		IBOX450GR206	I Box 450 mm Grey Height 206 mm	Set	4755.00	4 Set
		IBOX500GR206	I Box 500 mm Grey Height 206 mm	Set	4755.00	4 Set
		IBOX550GR206	I Box 550 mm Grey Height 206 mm	Set	4755.00	4 Set
		IBOX400AN206	I Box 400 mm Anthracite Height 206 mm	Set	4755.00	4 Set
		IBOX450AN206	I Box 450 mm Anthracite Height 206 mm	Set	4755.00	4 Set
		IBOX500AN206	I Box 500 mm Anthracite Height 206 mm	Set	4755.00	4 Set
		IBOX550AN206	I Box 550 mm Anthracite Height 206 mm	Set	4755.00	4 Set
		IBOX400MO206	I Box 400 mm Mocha Height 206 mm	Set	4855.00	4 Set
		IBOX450MO206	I Box 450 mm Mocha Height 206 mm	Set	4855.00	4 Set
		IBOX500MO206	I Box 500 mm Mocha Height 206 mm	Set	4855.00	4 Set
		IBOX550MO206	I Box 550 mm Mocha Height 206 mm	Set	4855.00	4 Set

Gallery Railing		Code	Description	Unit	MRP	Package Content
		IBOXGLYGR400	I Box Gallery Railing Grey 400 mm	Set	601.00	20 Set
		IBOXGLYGR450	I Box Gallery Railing Grey 450 mm	Set	601.00	20 Set
		IBOXGLYGR500	I Box Gallery Railing Grey 500 mm	Set	601.00	20 Set
		IBOXGLYGR550	I Box Gallery Railing Grey 550 mm	Set	601.00	20 Set
		IBOXGLYAN400	I Box Gallery Railing Anthracite 400 mm	Set	601.00	20 Set
		IBOXGLYAN450	I Box Gallery Railing Anthracite 450 mm	Set	601.00	20 Set
		IBOXGLYAN500	I Box Gallery Railing Anthracite 500 mm	Set	601.00	20 Set
		IBOXGLYAN550	I Box Gallery Railing Anthracite 550 mm	Set	601.00	20 Set
		IBOXGLYMO400	I Box Gallery Railing Mocha 400 mm	Set	651.00	20 Set
		IBOXGLYMO450	I Box Gallery Railing Mocha 450 mm	Set	651.00	20 Set
		IBOXGLYMO500	I Box Gallery Railing Mocha 500 mm	Set	651.00	20 Set
		IBOXGLYMO550	I Box Gallery Railing Mocha 550 mm	Set	651.00	20 Set



KITCHEN HARDWARE



WAVE		Code	Description	Unit	MRP	Package Content
SWING TRAY		IWAVESTL	I Wave Swing Tray Left	Set	21,252	Set
		IWAVESTR	I Wave Swing Tray Right	Set	21,252	Set
MAGIC CORNER		IWAVEMCFLR12	I Wave Magic Corner Frame Universal Left-Right Box	Set	19,764	Set
		IWAVEMCBLR22	I Wave Magic Corner Basket Universal Left-Right Box	Set	10,642	Set
3/4 CORNER CAROUSEL		IWAVECC	I Wave 3/4 Corner Carousel	Set	9,470	Set

TU		Code	Description	Unit	MRP	Package Content
PULL OUT LADDER PANTRY		ITUPOLPF13	I Tu Pantry Pull Out Ladder Fram Box (1/3)	Set	15,309	Set
		ITUPOLPBR23	I Tu Pantry Pull Out Ladder Bottom Runner Box (2/3)	Set	4,593	Set
		ITUPOLPB33	I Tu Pantry Pull Out Ladder Basket Box (3/3)	Set	10,716	Set
PANTRY DUO		ITUPD450F12	I Tu Pantry Duo 450mm Frame Box (1/2)	Set	21,132	Set
		ITUPD450B22	I Tu Pantry Duo 450mm Basket 6+6 Box (2/2)	Set	11,379	Set
		ITUPD600F12	I Tu Pantry Duo 600mm Frame Box (1/2)	Set	24,962	Set
		ITUPD600B22	I Tu Pantry Duo 600mm Basket 6+6 Box (2/2)	Set	13,441	Set

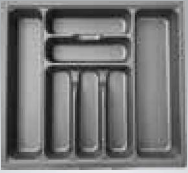
BIN		Code	Description	Unit	MRP	Package Content
WASTE BIN		IBIN14L	I Bin SS With Plastic Waste Bin 14 LTR	Set	3,260	Set

FORM		Code	Description	Unit	MRP	Package Content
CUTLERY TRAY		ICT450	I Form Cutlery Tray 450mm	Set	633	Set
		ICT500	I Form Cutlery Tray 500mm	Set	690	Set
		ICT600	I Form Cutlery Tray 600mm	Set	816	Set
		ICT900	I Form Cutlery Tray 900mm	Set	1,576	Set
GLASS TRAY PLATE TRAY		IGTPT600	I Form Glass Tray Plate 600mm	Set	3,786	Set
		IGTPT900	I Form Glass Tray Plate 900mm	Set	5,482	Set

BOX		Code	Description	Unit	MRP	Package Content
BOTTLE PULL OUT		IBOXBPO500GR	I Box Bottle Pull Out Grey 500mm	Set	7,000	Set
		IBOXBPO500AN	I Box Bottle Pull Out Anthracite 500mm	Set	7,000	Set
		IBOXBPO500MO	I Box Bottle Pull Out Mocha 500mm	Set	7,000	Set



dorsët
we understand

MAGNETO

DOOR CATCHER

In Technical Collaboration with



NEW



MDS-CL | MDS-GM

Magneto

Magneto's major function is to operate as a trip hazard free, fully concealed, aesthetically pleasing doorstop.

Magneto's patented striker plate design not only allows for smooth activation and deactivation, it also hold's your door firmly in place as a world leading hold-open device door-stop.

With all components concealed either within the door or the floor, Magneto is 100% trip hazard free making it ideal for commercial, hospital, hotel, retirement and general use.

WATCH PRODUCT DETAIL VIDEO ON YOUTUBE

MRP:810/-



Magnet Causes Pin To Lift From The Floor Sleeve





Dorset Industries Private Limited

CIN:U29300DL2017PTC326885

Corp. Office :

AIHP Horizon | 445 | Udyog Vihar Phase V | Sector - 19 | Gurugram | Haryana | 122008 | INDIA
Phones: + 91-124-4567890 | website : www.dorsetindia.com | E-mail: response@dorsetindia.com

Branch Offices :

Bengaluru | Hyderabad | Kolkata | Pune | Mumbai

Works :

Bhorakalan | Binola Industrial Area | NH-8 | Gurugram | Haryana | 122413

Copyright © 2021

ALL RIGHT RESERVED

Reproduction or transmission in any form or by any means electronic or mechanical of this publication in part or whole is prohibited, including photocopy, recording or any other information storage and retrieval system, without prior permission from Dorset Industries Private Limited We reserve the right to make alteration to the model without prior notice. All sizes are finished as portrayed through photographs in this catalogue may vary from the actual product. Please check physical product before placing your order.

dorsëtcare  **Call at: 1800 11 4448**



SCAN TO DOWNLOAD ALL
PRODUCT BROCHURES & PRICELISTS

www.dorsetindia.com

Follow us on    