



GREENPLY INDUSTRIES LIMITED

Decorative Division, 1501-1505, Narain Manzil,
23, Barakhamba Road, New Delhi – 110001, India.
Tel: (91) 11 42791399, E-mail: decosales@greenply.com,
Website: www.greenlam.co.in

Green DESIGN STUDIO

Laminates & Veneer Experience Center

AHMEDABAD
109, Ashirwad Paras,
Corporate Road,
Opposite Prahlad Nagar Garden,
Ahmedabad - 380015.

BANGALORE
142, 1st Main Road,
Sheshadripuram,
Bangalore – 560020.
Tel: 080-23317084/ 23445729

BHATINDA
Amrik Singh Road,
Bhatinda.
Tel: 0164-5000234
09041822400/09888241417

BHOPAL
Guru Kripa Complex,
Shop No. 8, Ground Floor,
M. P. Nagar, Zone – II Bhopal.
Tel: 0755-2550574

BHUBANESWAR
Plot No.14B,
Janpath Bapujinagar,
Bhubaneswar-751009, Orissa.
Tel: 09437364488

ERODE
45/10, Pari Nagar,
Perundurai Road,
Palayapalayam, Erode-638011.
Tel: 9750577771/ 70

HYDERABAD
Banjara Hills Road No. 4,
Opp. Lane to GVK Mall,
Hyderabad – 5000034
Tel: 040-65265236

INDORE:
UG 02 Morya Arcade
1/2 Old Palasia,
Opp. Palasia Police Station,
Indore – 452001

JAIPUR:
264, New Atish Market,
Gopalpura By Pass,
Mansarowar, Jaipur
Tel: 0141-2399550

LUDHIANA
Shop No. 343, Bus Stand Road,
Bharat Nagar Chowk, Ludhiana.
Tel: 0161-2770380

RANCHI
Rattanlal Compound (Opposite Rospa
Tower), Main Road, Ranchi,
Jharkhand – 834009.
Tel: 0651-2332580

GREEN SHOPPE :
DHANBAD Green Shoppe: Jora Phatak Road,
Opp Shakthi Mandir, Dhanbad. Tel: 09334000040/ 09431317007

CHANDIGARH Green Shoppe: SCO 5, Sector 7C, Madhya Marg.
Tel: 0172 5077262

KARNAL Green Shoppe: 92, Janta Grain Market, Karnal – 132001
Tel: 09215164005

UDAIPUR Green Shoppe: 51, Shastri Marg, Ashok Nagar Main Road,
Udaipur – 313001 Tel: 0294 - 2413021

DOMESTIC BRANCHES

AHMEDABAD: 079-26640244/ 26642880 **BANGALORE:** 080-22118721 **BHUBANESHWAR:** 0674-2394230 **CHANDIGARH:** 0172-5073185
CHENNAI: 044-42822672/ 42822673/ 42822671 **COIMBATORE:** 0422-4370407 **DELHI:** 011-41040533/32/31 **GHAZIABAD:** 0120-4131561/ 09717595741
GURGAON: 0124-4221721/ 4047907 **GUWAHATI:** 0361-2733306 **HYDERABAD:** 040-24801429 **INDORE:** 0731-4230297/ 4206153
JAIPUR: 0141-4039812/ 2261747 **KOCHI:** 0484-2531596 **KOLKATA:** 9748743203/204 **LUCKNOW:** 0522-4000475 **MUMBAI:** 022-26125203/ 26125204
NAGPUR: 0712-2421129/ 3296859/ 2420607 **NASHIK:** 0253 - 2341124 / 2341116 **PATNA:** 0612-3212527/28 **PUNE:** 020-26169307
RAIPUR: 0771-8460340 **RANCHI:** 9934314471/ 9934314472 **ROHTAK:** 01282-249502/ 09996939611 **ROURKELA:** 9777454080
SILIGURU: 0353-2522428/9800863655 **SURAT:** 9909983390 **THANE :** 9167887942 **VJAYWADA:** 0866-2523135



www.greenlamsturdo.com



Sturdo
RESTROOM CUBICLES AND LOCKER SOLUTIONS

www.greenlamsturdo.com

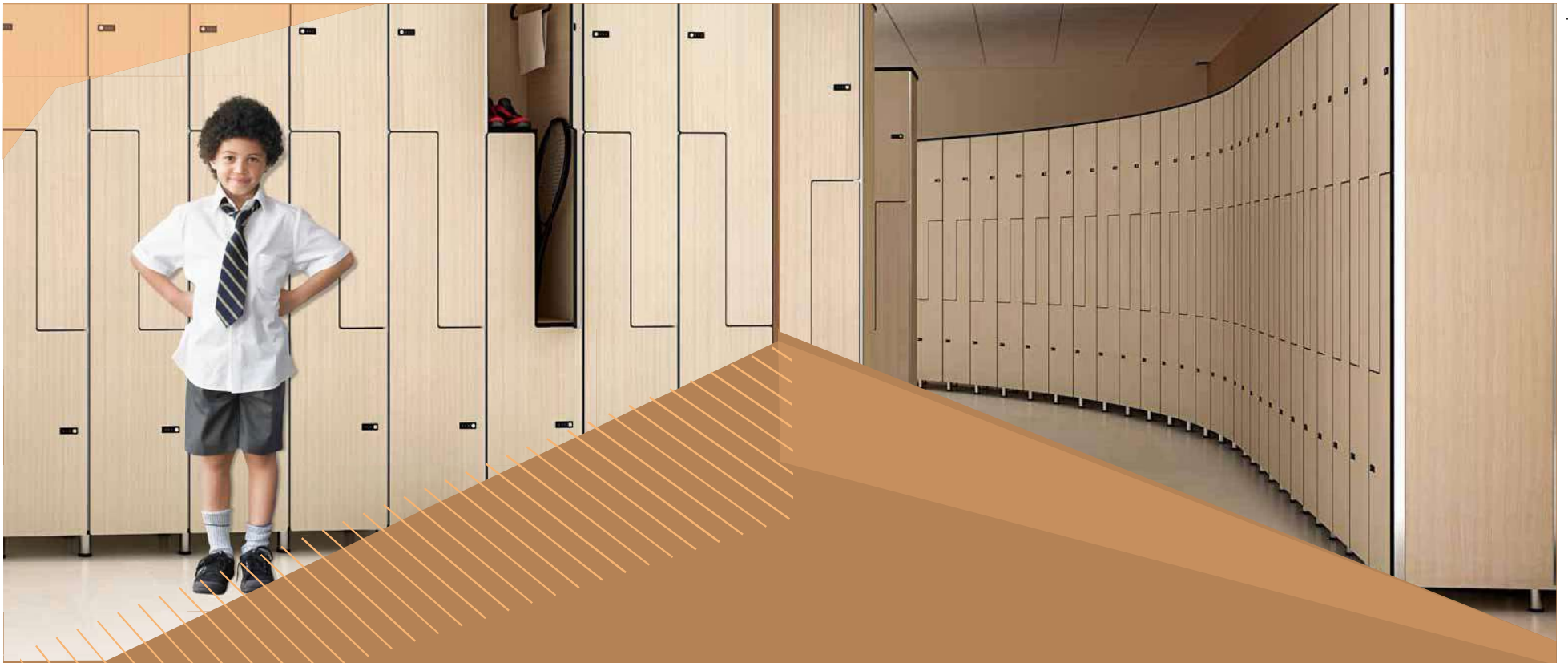

CONTENTS

COMPANY OVERVIEW	2	VIBRANCE COLLECTION	62
ENGINEERED TO PERFORM	4	LOCKER SYSTEMS	80
FEATURES	6	PRIVY DIVIDER PANELS AND HAND HOLDS	98
MATERIAL COMPOSITION	8	OUR CERTIFICATION	100
FRESH ARRIVALS	10	SOME OF OUR PRESTIGIOUS PROJECTS	102
KIDS' COLLECTION	12	ANNEXURE	104
DESIGNER COLLECTION	26	LAMINATE DESIGN COLLECTION	120
CLASSIQUE COLLECTION	36	TECHNICAL SPECIFICATIONS	122



COMPANY OVERVIEW

For years Asia's leading brand of laminates, Greenlam has manufactured products which promises to perform beyond comparison. From developing technology to designs with superior functionality, Greenlam has always received appreciation from the industry and customers across the globe.

Backed by ISO 9001, ISO 14001, OHSAS 18001 awards for offering advanced product line along with world-class working systems, Greenlam has also received global recognitions, namely –NEMA,BS and EN-438 for meeting rigid international standards, it has also received recognition with the prestigious GREENGUARD certifications for producing eco-friendly and sustainable products.

With Greenlam Sturdo it offers you an exceptional restroom space and locker solutions range which gives a complete solution for adding a spectacular look.

ENGINEERED TO PERFORM

Greenlam Sturdo is an incredible assortment of restroom and locker solutions, embellished with Raw Silk Finish and Anti Bacterial Laminates. It also offers specially adapted Hand Holds for physically disabled and impressive privy Divider Panels which are extensively used for commercial applications and in public areas.

Engineered under indigenous technology, Greenlam Sturdo performs exceptionally even in heavy traffic areas, under high moisture and high humid conditions. Its unique product composition makes it suitable for Indian climatic conditions where toughness, performance and strong visual appeal becomes essential. The company has also paid special attention to the needs of the physically challenged by additionally designing restroom space products in accordance to the ADA (Americans with Disabilities Act, 1990) guidelines. Since customer satisfaction is the utmost priority we make sure that our extensive range of restroom products and Lockers are available on a proper supply basis to ensure timely distribution and installation by our competent technicians. Along with our dedicated after sales service support we also offer an assurance of unprecedented 10 years of warranty on our range of compact laminates against any manufacturing or moisture related defects.



Not just beautiful, these laminates make the surfaces of restrooms and lockers germ-free and secure. Produced by permanently incorporating a US-EPA approved, well-known and widely used anti-microbial agent during the manufacturing, this range ensures complete health and hygiene for you and your family. Wish you a happy and healthy life ahead!

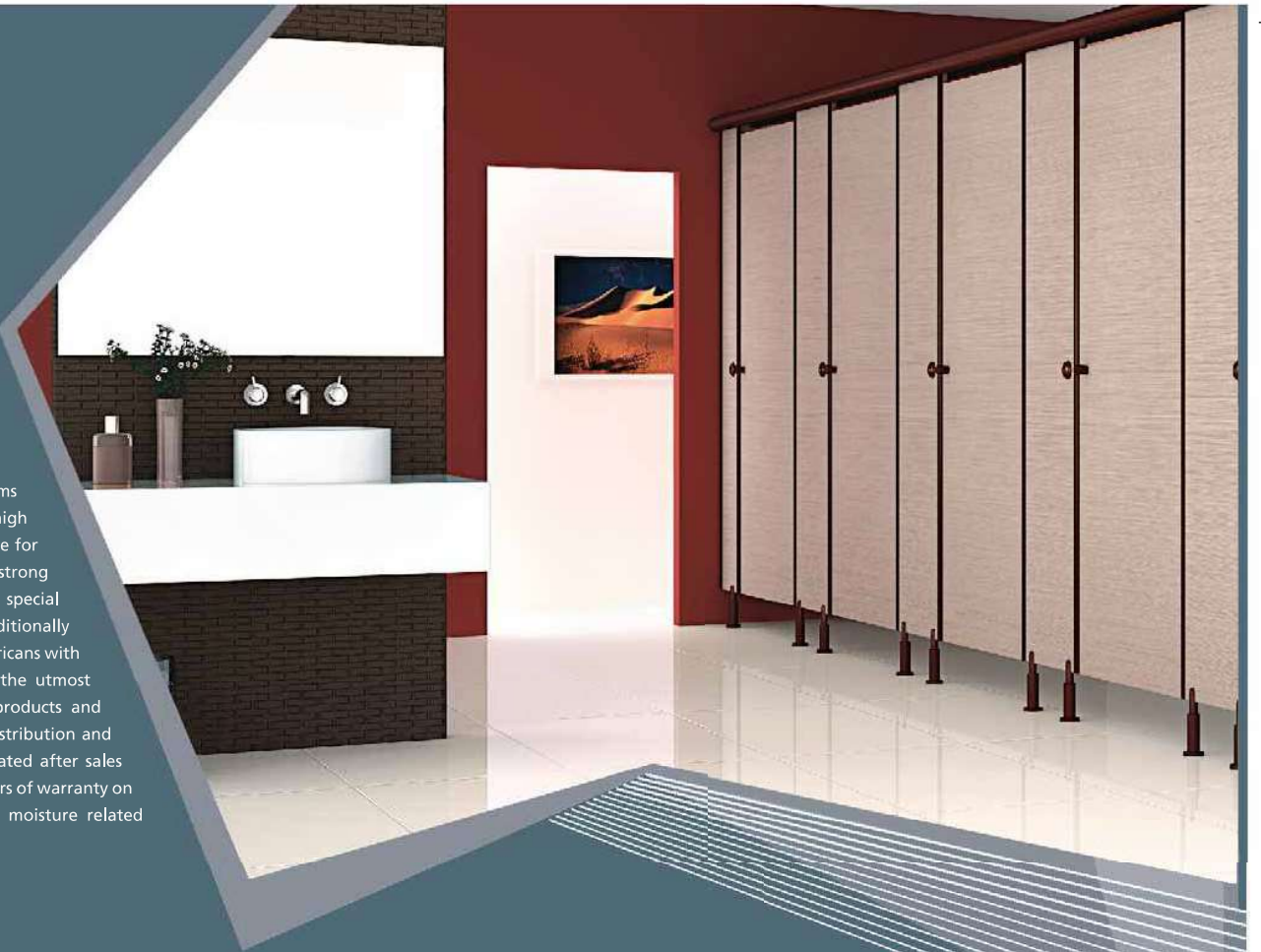

GREENLAM STURDO RESTROOM CUBICLES AND LOCKER SOLUTIONS



Presenting a new world of restroom cubicles and locker solutions studded with innovative designs and unique features. A remarkable collection of divider panels, doors, locker solutions and restroom cubicles are available in various styles and ranges.



FEATURES

- Available in anti bacterial grade
- Exclusive raw silk finish available
- Manufactured in accordance to ISO 2046
- Formulated by using superior quality high pressure compact laminates
- Built with nylon polyamide, stainless steel and aluminum hardware fittings
- Available in standard and special dimensions to cater to the needs of physically disabled people
- These restroom cubicles and locker solutions are available in various sizes, shapes and colour hues
- Designed for providing better durability and performance
- Hygienic and easy to maintain
- Variety of Restroom Cubicles for kids
- Also offers designer cut cubicles for more aesthetic appeal

ADVANTAGES OF GREENLAM STURDO

- | | |
|--|--|
|  Hygienic and easy to maintain |  High wear and abrasion resistance |
|  Resistant to harmful germs and cleaning agents |  Manufactured in strict adherence to accepted fire Safety norms |
|  Noise deafening system to avoid disturbing "door banging" sound |  Best in class international accessories |
|  Wide spectrum of colours to choose from |  Equipped with emergency opening provisions |
|  Resistant to cigarette burns |  Exceptional water, humidity and high temperature resistance |
|  High quality Compact laminates manufactured as per international standards |  Germ-free anti-bacterial laminates |



WET VS. DRY RESTROOM SYSTEM

Wet restroom system is the conventional way of setting up a restroom. It generally comprises of a structure made from brick walls and tiles coupled with the required hardware. One of the major drawbacks of a wet restroom setup is that the partition walls and doors are placed on the floor hence it becomes more prone to water, dust, dirt and stain settlements which leaves a pungent smell. In case of dry restroom, it's equipped with modern designing and is a reasonably priced setup. The main advantage of having this system is economy of space, usage of 12 mm/18 mm thick partitions and doors in comparison to 150 mm brick walls. There is always a gap maintained between the ground and the partition to avoid dust, dirt and pungent smell.

WHY PREFER A DRY RESTROOM SYSTEM?

Greenlam Sturdo stays class apart due to its usage of dry restroom system. An analysis to support the following is mentioned below:

DISADVANTAGES OF WET SYSTEM

- Cleaning of floor becomes difficult
- Dirt and stains easily settle down on the bottom because of its porous surface
- Tile designs can go out of production making its replacement difficult
- Since the grout joints are porous they can easily absorb pungent smell
- Loss of space - Usage of 6' x 6" thick walls result in loss of 3 sq.ft area per partition
- Load of building is high
- No means of natural ventilation is provided

ADVANTAGES OF DRY SYSTEM

- Economy of space- The partition panels are only 12 mm or 18mm thick as compared to 150mm thick brick wall
- Economy of load- Partitioning systems reduces the load on building as compared to the usage of brick wall
- Reduced installation time- 4 cubicles can be setup in a day
- Neatness- Since no wet work is involved
- Proper air ventilation access is provided in the designs
- Easy floor cleaning- Absence of corners doesn't let the dust to accumulate on the floor
- Vibrant range- Available in different colours and patterns

MATERIAL COMPOSITION

Compact Laminate construction

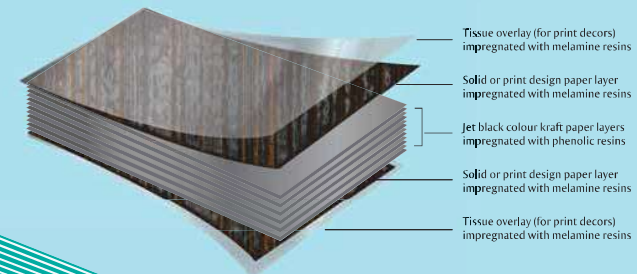

Greenlam Sturdo collection is formulated by using high pressure, self-supporting, decorative-Greenlam Compact Laminates. Its surface is composed of sheets of decorative paper impregnated with melamine resins and the thickness is achieved with sheets of kraft paper which are infused with thermosetting resins. These sheets are then bonded together by means of heat and high pressure, to make it resistant to stains, extreme temperatures, water, moisture, etc.

Thus, the incomparable distinctiveness of Greenlam Compact Laminates make them ideal for both horizontal and vertical applications where the surface should be functional, durable and decorative.

Adding to that Greenlam Compact Laminates are made anti-bacterial by permanently incorporating a US-EPA approved, well-known and widely used anti-microbial agent during the manufacturing.

HARDWARE DETAILS

To maintain the right balance between performance, economy and aesthetics, Greenlam Sturdo offers you an assortment of hardware fittings. Developed from high quality imported materials, the hardware fittings are available in nylon polyamide, aluminum and stainless steel finishes.

The stainless steel hardware is accessible in two distinct options. They both possess different characteristics which make them suitable for diverse applications.

SS Grade 304 is the standard "18/8" stainless steel. It is the most adaptable and widely used stainless steel, available in various forms and finishes. It has an excellent forming and welding characteristics. And while welding thin sections, post-weld annealing is not required due to this. The balanced austenitic structure of SS Grade 304 enables it to be severely deep drawn without intermediate annealing which has made this grade dominant in the manufacture of drawn stainless parts such as sinks, hollow-ware and saucepans.

SS Grade 316 is an improved version of SS Grade 304 since it additionally consists of molybdenum and slightly higher nickel content. The composition of SS Grade 316 gives the steel much increased corrosion resistance in many aggressive environments. Molybdenum makes the steel more resistant to pitting and crevice corrosion in chloride-contaminated media, sea water and acetic acid vapours. SS Grade 316 offers higher strength and better creep resistance at higher temperatures than SS Grade 304. And performs remarkably at sub-zero temperatures due to its excellent mechanical and corrosion properties.

KIDS' COLLECTION

Taking fun a notch higher

Our kids' collection opens up a new world of fun, excitement and adventure with stylish designs.

These cubicles are suited to infant school environments and are versatile with three standard models that make them ideal for nurseries, junior and senior schools.

The optional arched tops to the doors and shaped partitions create a washroom environment that is imaginative and artful whilst providing the necessary requirements for supervisory care.

These cubicles can be manufactured in any combination of colours from the exhaustive colour range and come complete with complementing hardware in stainless steel finish.

Available Models

- Kiddie World
- Crazy Balls
- Picket Fence

KIDDIE WORLD

A lively, colorful, safe and sturdy world, especially designed to enhance the artistic side of the kids. As its unique shape open the world of imagination for kids, the vivid use of colors craft different strokes of creativity on kids' minds. Made using stainless steel hardware and accessories like door knob, gravity hinges thumb turn lockset indicators coat hooks, these cubicles are designed for a longer durability. The U-channels, SS-shoe box plate, MS- base plate, rubber noise deafening tape, screws and wall plugs add that extra toughness to these restroom cubicles. After all crafting such perfection is not child's play.

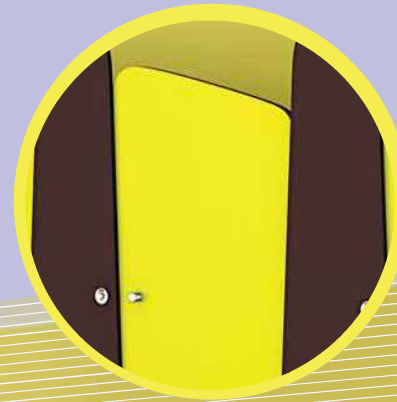

EU-ENCLOSED UNIT

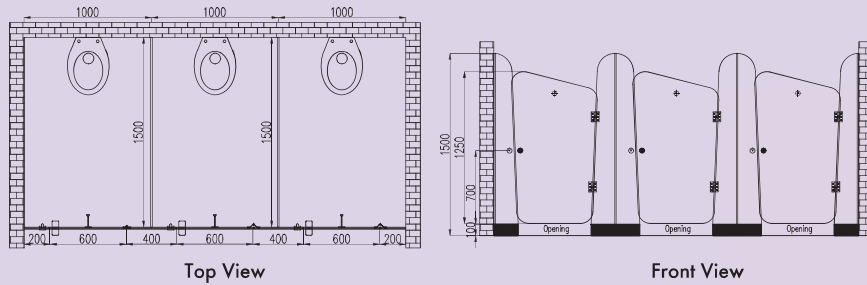

CU-CORNER UNIT

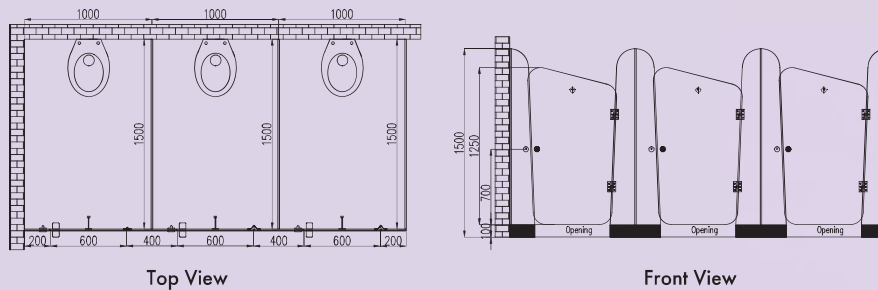

HARDWARE FIXING DETAILS

All pilasters are supported by L- bracket with floor anchor bolt which is concealed with stainless steel flat box-up of height 100mm. The stainless steel box-up is available in SS Grade 304 and 316 options. The intermediate panels are fixed onto the wall with stainless steel (Grade-304) U- channel section and SS 304 screw insert.



HARDWARE DETAILING

Each restroom cubicle is equipped with the following set of hardware fittings:

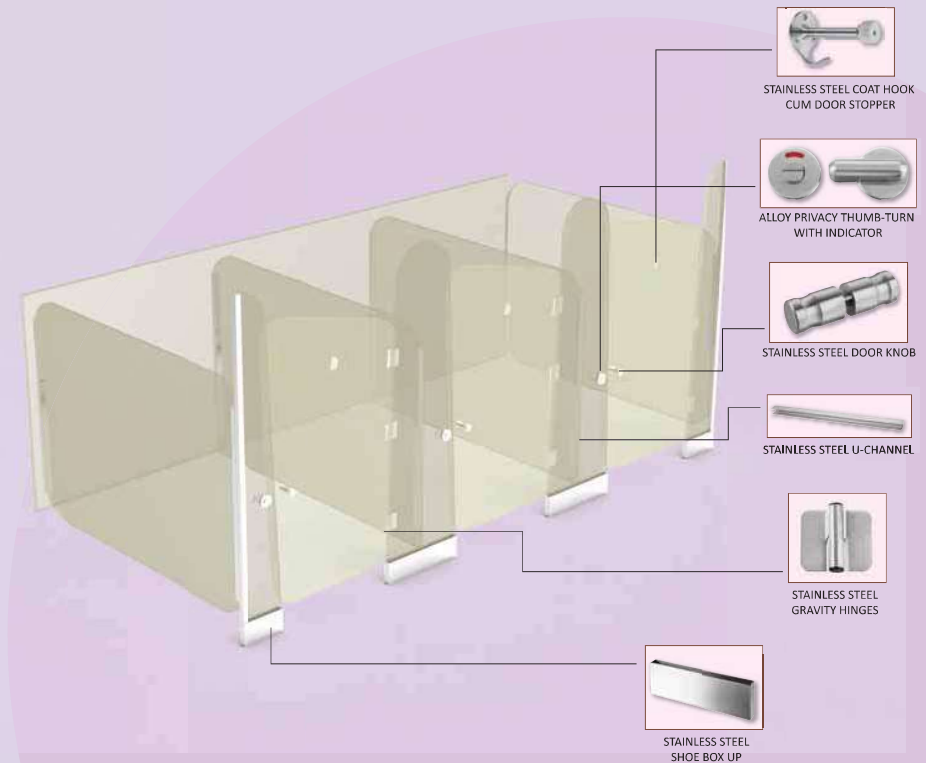

DIMENSION DETAILING

Standard Dimension	General (mm)	Physically challenged (mm)
Width of Cubicle	1000	1500
Depth of cubicle	1500	1700
Height of Divider	1200	1200
Height of entire cubicle	1500	1500
Width of door	600	900
Height of door	1250	1250
Ground clearance	100	100

CRAZY BALLS

Games. They always excite kids. And to give a daily dose of excitement to kids we present Crazy Balls Restroom cubicle theme. Inspired by the kids, for the kids, this design will never run out of excitement. Ensuring these bowling pins don't fall like the real ones, they are being supported by stainless steel U-channels, SS-shoe box plate, MS-base plate, rubber noise deafening tape, screws and wall plugs. Let the fun game begin.

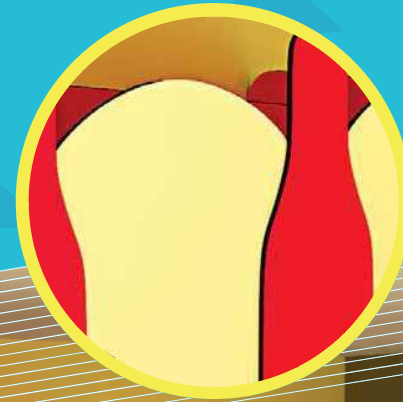

EU-ENCLOSED UNIT

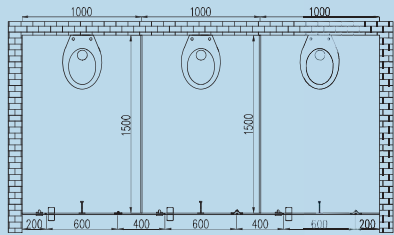

Top View

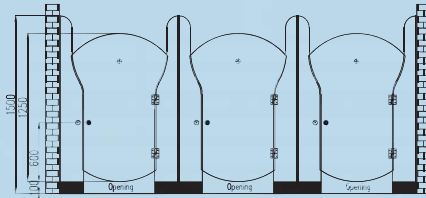

Front View

CU-CORNER UNIT

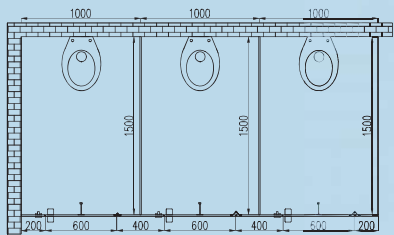

Top View

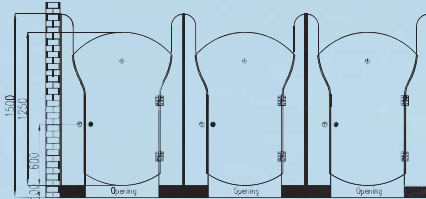

Front View

HARDWARE FIXING DETAILS

All pilasters are supported by L- bracket with floor anchor bolt which is concealed with stainless steel flat box-up of height 100mm. The stainless steel box-up is available in SS Grade 304 and 316 options. The intermediate panels are fixed onto the wall with stainless steel (Grade-304) U- channel section and SS 304 screw insert.



HARDWARE DETAILING

Each restroom cubicle is equipped with the following set of hardware fittings:

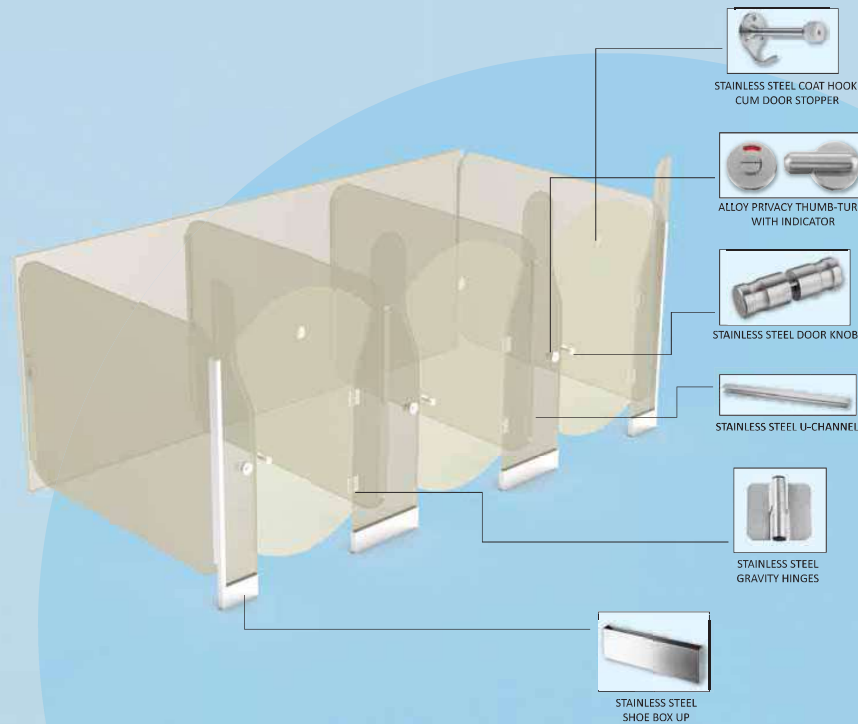

DIMENSION DETAILING

Standard Dimension	General (mm)	Physically challenged (mm)
Width of Cubicle	1000	1500
Depth of cubicle	1500	1700
Height of Divider	1200	1200
Height of entire cubicle	1500	1500
Width of door	600	900
Height of door	1250	1250
Ground clearance	100	100

PICKET FENCE

It's a world of colorful fences interspersed with other forms and icons replete with vibrant imagery, creating fun and laughter zones for kids. To make sure that the fun never ends, these cubicles are made sturdier with stainless steel door knob, gravity hinges, thumb turn lockset indicators, coat hooks, U-channels, SS-shoe box plate, MS- base plate, rubber noise deafening tape, screws and wall plugs. Let there be giggles and laughter all over the fences.

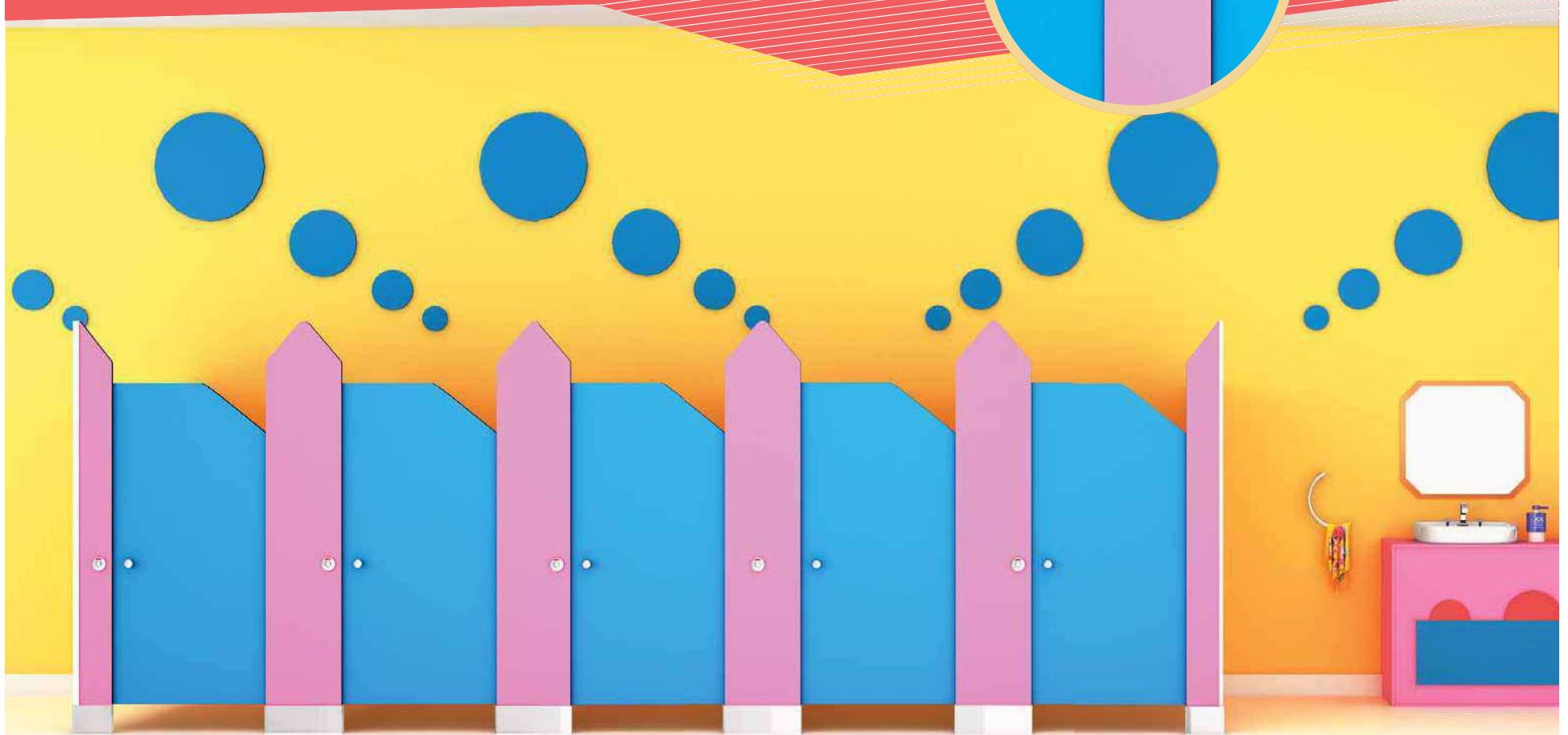
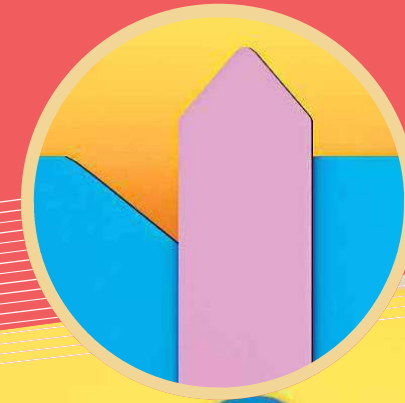

EU-ENCLOSED UNIT

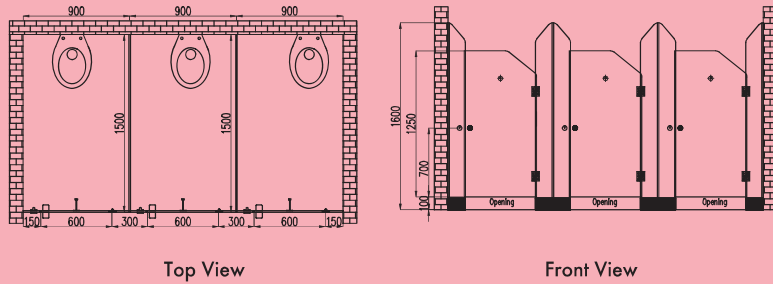

CU-CORNER UNIT

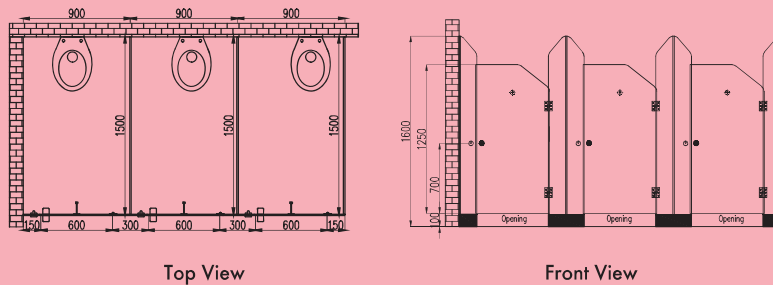

HARDWARE FIXING DETAILS

All pilasters are supported by L- bracket with floor anchor bolt which is concealed with stainless steel flat box-up of height 100mm. The stainless steel box-up is available in SS Grade 304 and 316 options. The intermediate panels are fixed onto the wall with stainless steel (Grade-304) U- channel section and SS 304 screw insert.



HARDWARE DETAILING

Each restroom cubicle is equipped with the following set of hardware fittings:

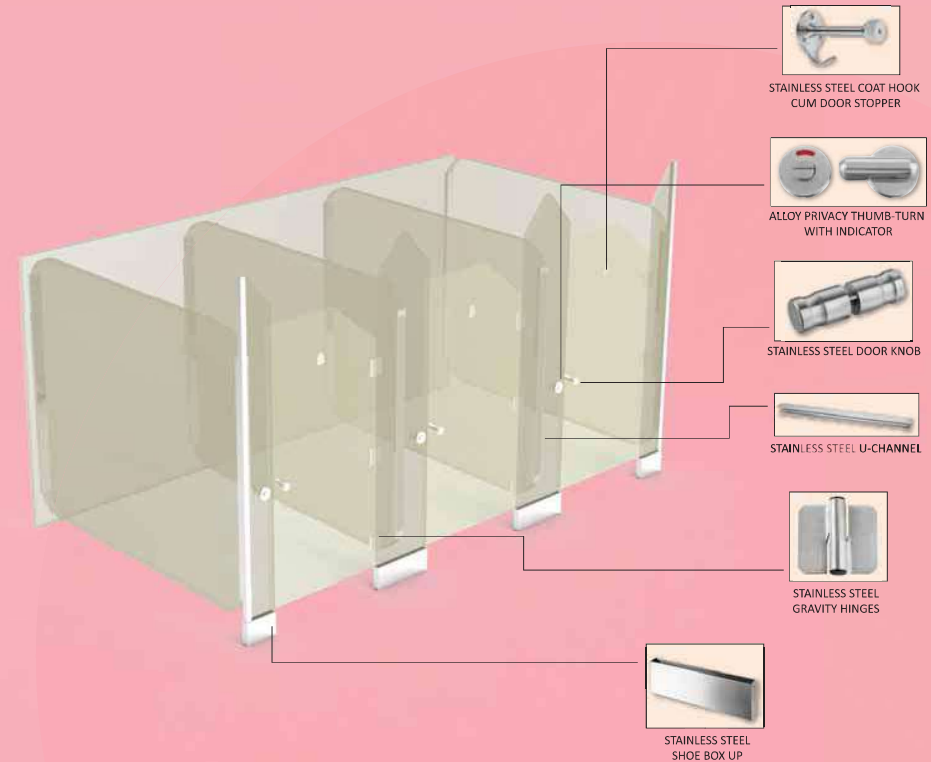

DIMENSION DETAILING

Standard Dimension	General (mm)	Physically challenged (mm)
Width of Cubicle	900	1500
Depth of cubicle	1500	1700
Height of Divider	1200	1200
Height of entire cubicle	1600	1600
Width of door	600	900
Height of door	1250	1250
Ground clearance	100	100

DESIGNER COLLECTION

Offering freedom from limited designs and patterns, Greenlam Sturdo enables you to modify the restroom cubicles into a stylish place. With 2 exclusive designs, these designer restroom cubicles are the answer to your search for a restroom that is as stylish as you are. So just step into the artist's shoe, run your imagination and create the masterpiece with these revolutionary restroom cubicles and transform a mundane space into a designer solution.

Available Models

- ARCS
- ALP



ARCS

Treat yourself with the ambiance which is simple yet stylish. Now exhibit your elegance with our exciting range of Designer Restroom Cubicles especially built for providing durability and meeting the aesthetic requirements. Arcs Restroom Cubicles are made available with stainless steel hardware and accessories which not only amplify their aesthetic but also lend them sturdiness and longevity.



Designer Doors & Partitions



Alloy Privacy Indicator



Alloy Privacy Thumb turn



Stainless Steel Shoe Box Up



EU-ENCLOSED UNIT

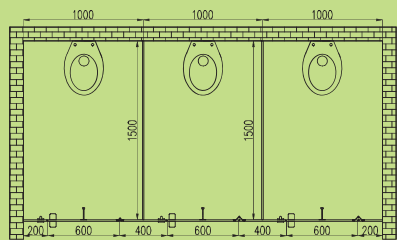

Top View

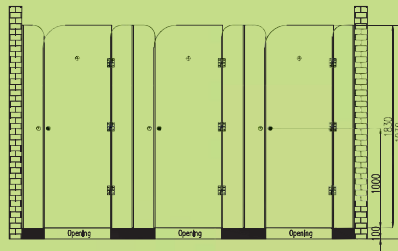

Front View

CU-CORNER UNIT

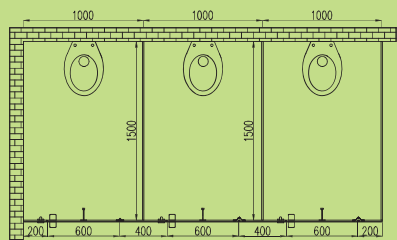

Top View

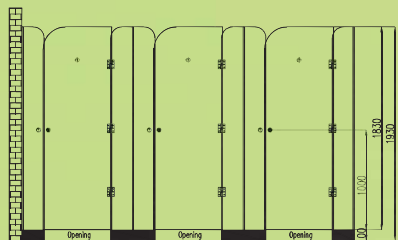

Front View

HARDWARE FIXING DETAILS

All pilasters are supported by L- bracket with floor anchor bolt which is concealed with stainless steel flat box-up of height 100mm. The stainless steel box-up is available in SS Grade 304 and 316 options. The intermediate panels are fixed onto the wall with stainless steel (Grade-304) U- channel section and SS 304 screw insert.



PILASTER

WALL

DOOR

HARDWARE DETAILING

Each restroom cubicle is equipped with the following set of hardware fittings:

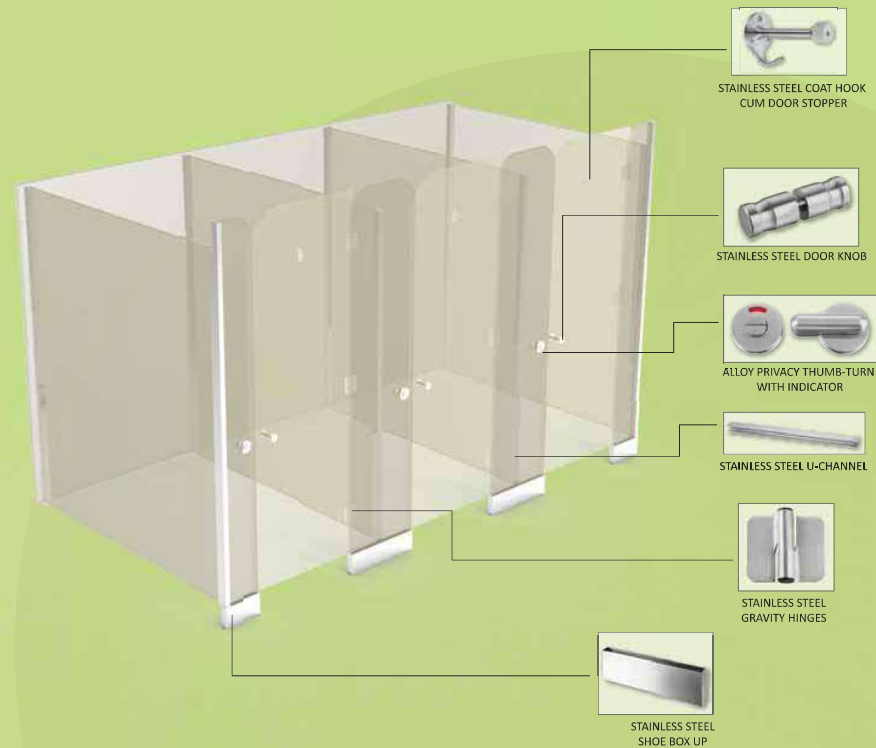
STAINLESS STEEL COAT HOOK
CUM DOOR STOPPER

STAINLESS STEEL DOOR KNOB

ALLOY PRIVACY THUMB-TURN
WITH INDICATOR

STAINLESS STEEL U-CHANNEL

STAINLESS STEEL
GRAVITY HINGESSTAINLESS STEEL
SHOE BOX UP

DIMENSION DETAILING

Standard Dimension	General (mm)	Physically challenged (mm)
Width of Cubicle	1000	1500
Depth of cubicle	1550	1750
Height of Divider	1830	1830
Height of entire cubicle	1930	1930
Width of door	600	900
Height of door	1830	1830
Ground clearance	100	100

Note:
• On special demand over all height of front view can be increased up to 2100 mm.

ALP

Alp Restroom Cubicles are simple yet contemporary. These designer restroom cubicles come with the most extensively used stainless steel hardware coupled with sturdiness of high pressure 12mm Compact Laminate. Alp restroom cubicles are highly durable as it has standard adjustable foot along with stainless steel top rail, providing them the extra strength. These natural looking cubicles are lively, safe and easy to fit.

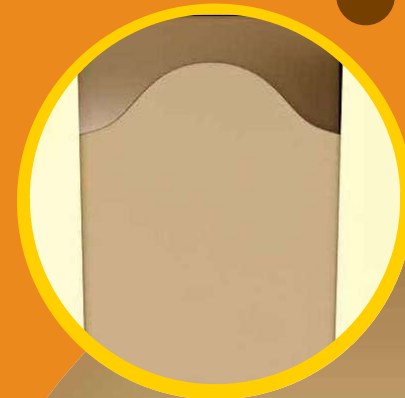
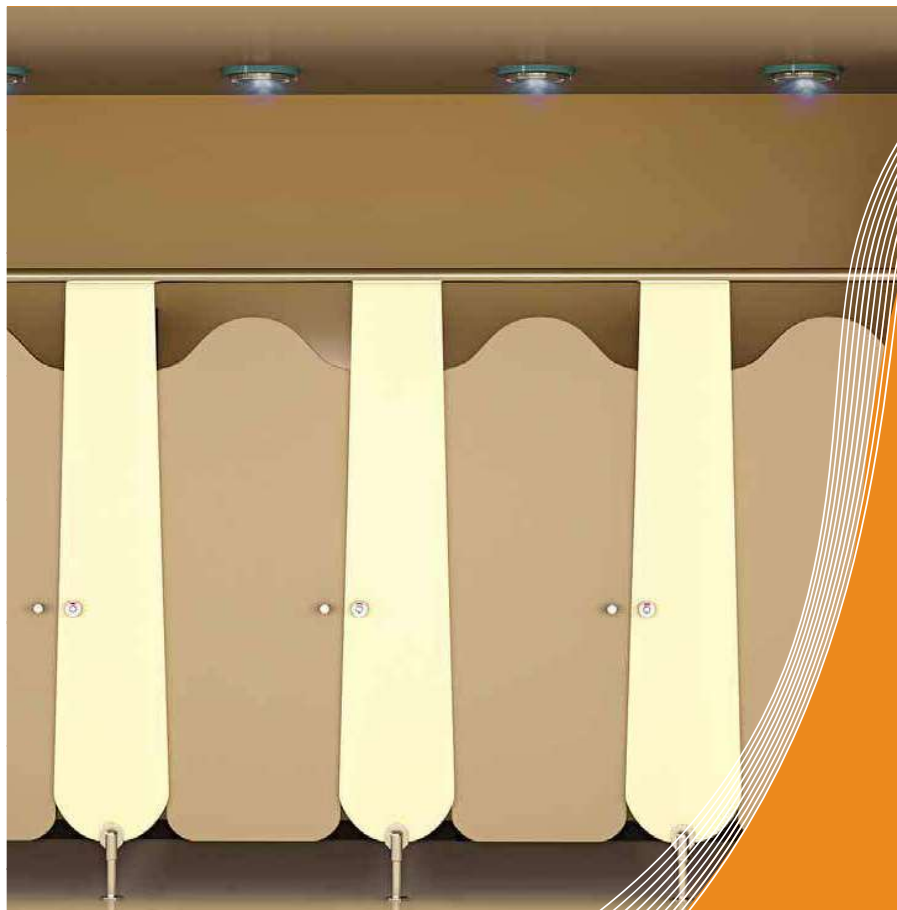

Designer Doors



Alloy Privacy Indicator



Alloy Privacy Thumb turn



Stainless Steel Adjustable Foot



EU-ENCLOSED UNIT

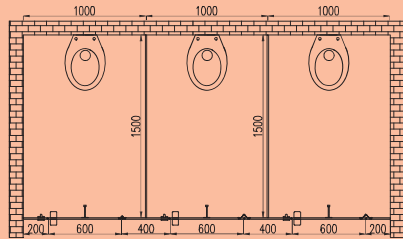

Top View

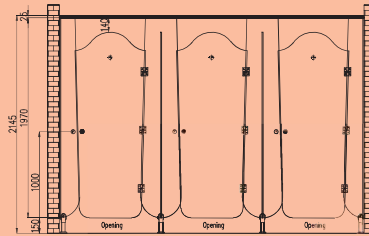

Front View

CU-CORNER UNIT

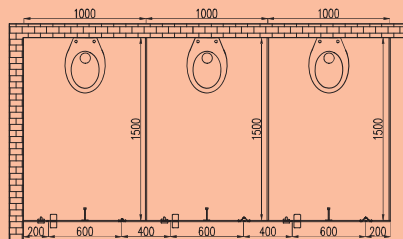

Top View

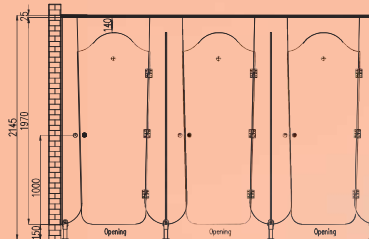

Front View

HARDWARE FIXING DETAILS

The adjustable foot that supports the pilasters is made from stainless steel (Grade- 304) and its base is anchored to the floor with SS screw & nylon plug. There is a ground clearance of 150mm. Aluminum U Channel are used to attach with the divider panels to the wall as well as the mid panel with stainless steel (Grade- 304) screw inserts. Aluminum top rail coated in natural anodized color is used to fix the pilaster at the top. Doors are incorporated with the noise deafening tape to reduce the noise effect. All other fittings like hinges, coat hook, adjustable foot and lock set indicator is manufactured in stainless steel.



HARDWARE DETAILING

Each restroom cubicle is equipped with the following set of hardware fittings:

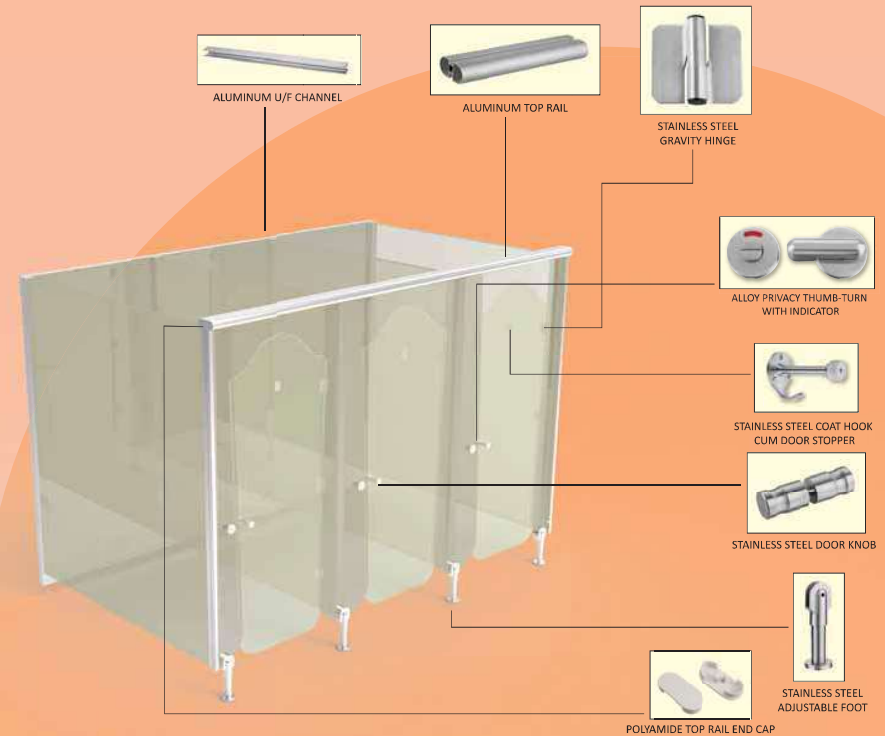

DIMENSION DETAILING

Standard Dimension	General (mm)	Physically challenged (mm)
Width of Cubicle	1000	1500
Depth of cubicle	1500	1750
Height of Divider	1830	1830
Height of entire cubicle	2145	2145
Width of door	600	900
Height of door	1830	1830
Ground clearance	150	150

CLASSIQUE

A commendable assortment of restroom cubicle collection, Classique comes with an eternal classiness of stainless steel and aluminum hardware to give an ideal combination of innovation with durability. Thus, the Classique series is specially formulated to meet various design needs and can be further classified by:

- Different hardware fittings like the standard adjustable foot, shoe box or top rail arrangements
- Combination of different materials use such as aluminum and stainless steel
- Thickness of Compact Laminate-12 mm and 18 mm

Now give your restrooms an admiring look with an extraordinary range available in six unique styles

- Floater
- Wings
- Evergreen
- Invincible
- Grandeur
- Versatile

CLASSIQUE- FLOATER

Classique Floater Cubicles are tailor-made for restrooms. These cubicles have a clear floor concept which is very friendly as far as the maintenance is concerned. These cubicles can be easily installed due to their contemporary designs. Their floater concept gives them a natural yet classic touch. To enhance the exquisiteness, all doors are 12mm thick and their stainless steel hardware fittings make these cubicles highly durable and long lasting. These cubicles are recommended for commercial complexes, sports clubs and gyms etc.



Aluminium Top Rail in SS finish



Alloy Privacy Indicator



Clear Floor Concept



Alloy Privacy Thumb Turn

EU-ENCLOSED UNIT

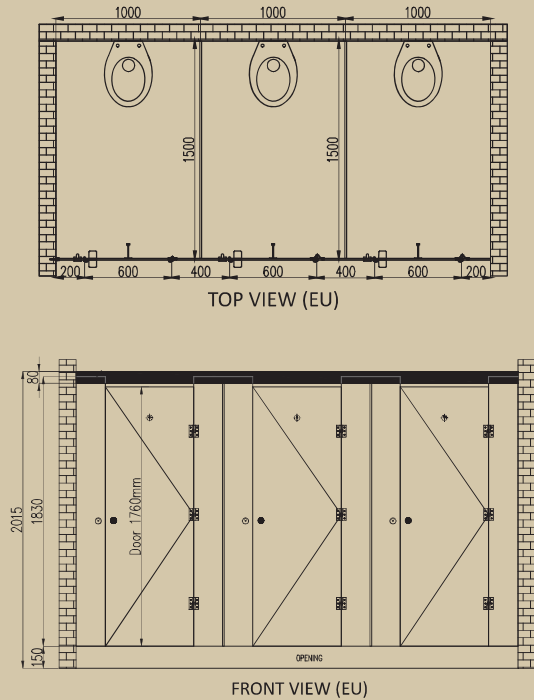

HARDWARE FIXING DETAILS

The aluminum hollow D shape Toprail (Grade- 6063 T-6) is first held to the concrete wall on both ends by MS 'L' angel which is fixed onto the wall with stainless steel screws. The front pilaster are fixed into the Toprail with stainless steel screw insert on the back side on Toprail, the SS U-Channel are attached with the divider panel to the wall as well as the mid panel. There is ground clearance of 150mm



HARDWARE DETAILING

Each restroom cubicle is equipped with the following set of hardware fittings:

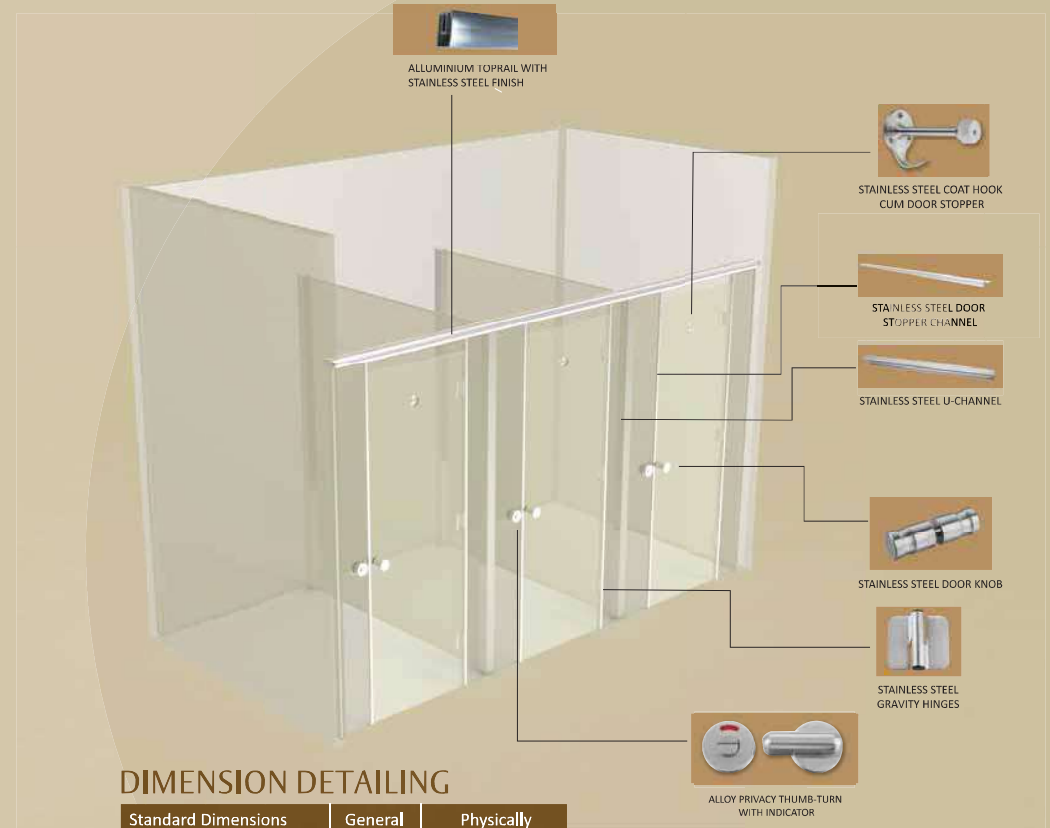

DIMENSION DETAILING

Standard Dimensions	General (mm)	Physically Challenged (mm)
Width of cubicle	1000	1500
Depth of cubicle	1500	1750
Height of divider	1785	1785
Height of entire cubicle	2015	2015
Width of door	600	900
Height of door	1760	1760
Ground clearance	150	150

CLASSIQUE WINGS

Add classic wings to your restrooms

Innovation with simplicity and splendor, Greenlam Sturdo presents you Classique Wings, a sparkling new assortment of restroom cubicles. Planned under the blueprints of aesthetics, this ceiling hung model has been designed to further enhance the beauty of your washrooms, while creating desirable spaces. Its unique shape and profile provide ample space to wipe the floors easily and without any hassles. So, introduce these exclusive masterworks to your rest rooms and enrich your creations, the contemporary and classic way.



Stainless Steel Gravity Hinges



Alloy Privacy Indicator



Stainless Steel Shoe Box Up



Stainless Steel Coat Hook cum Door Stopper

EU-ENCLOSED UNIT

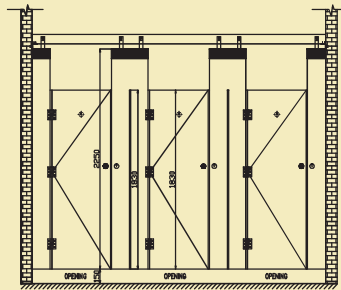

FRONT VIEW (EU)

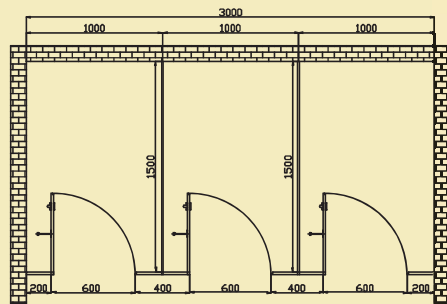

TOP VIEW (EU)

HARDWARE FIXING DETAILS

The aluminum hollow rectangle channel is first held above the false ceiling on both ends by MS'L' angle which is fixed onto the wall with 3 set of quality steel wall plus c/w bolts. The rectangle steel plates are next distributed equally, taking into consideration the position of the pilasters, and fixed onto the hollow MS top rail using bolts and screws.



HARDWARE DETAILING

Each restroom cubicle is equipped with the following set of hardware fittings:

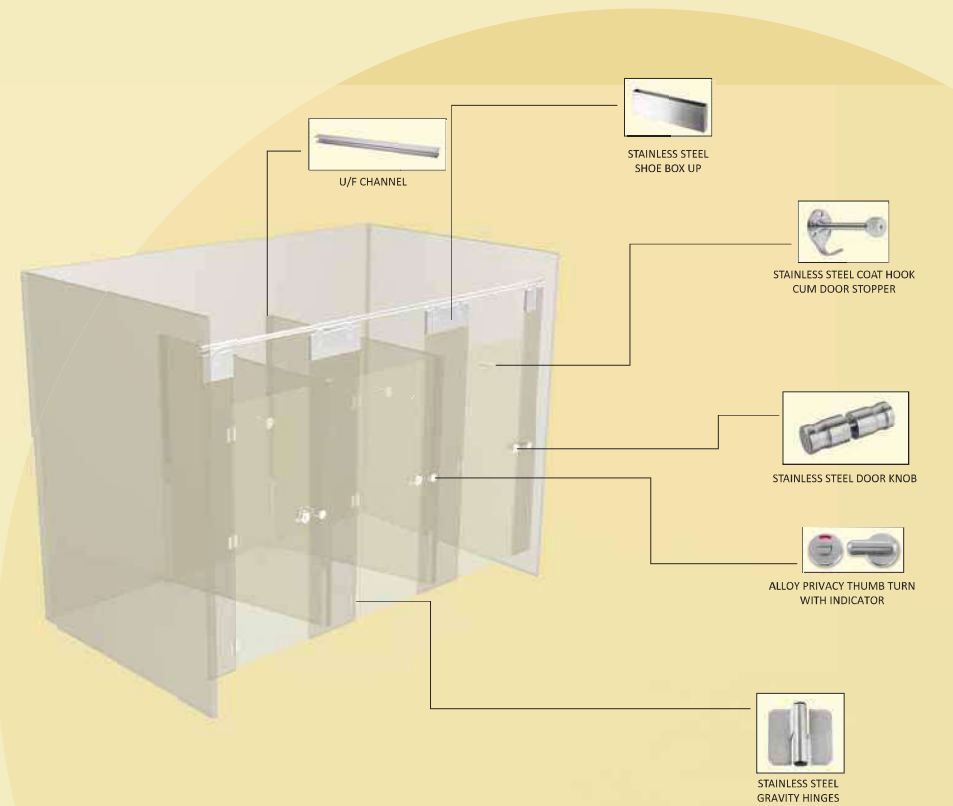

DIMENSION DETAILING

Standard Dimensions	General (mm)	Physically Challenged (mm)
Width of cubicle	1000	1500
Depth of cubicle	1500	1750
Height of entire cubicle	2400	2400
Width of door	600	900
Height of door	1830	1830
Ground clearance	100	100

CLASSIQUE- EVERGREEN

Simple yet contemporary is anonymous with Classique's Evergreen. The model comes with the most extensively used stainless steel hardware coupled with sturdiness of high pressure 12mm Compact Laminate. It offers standard adjustable foot along with stainless steel top rail for providing extra strength. The rest of the hardware like the hinges, locks, door knobs and coat hooks are also provided in stainless steel. Hence, making it an elegant and ideal option for heavy traffic areas where functionality matters the most.



Alloy Privacy Indicator



Alloy Privacy Thumb Turn



Stainless Steel Adjustable Foot



90° Upper Joint Stainless Steel Head Rail Corner Connector

EU-ENCLOSED UNIT

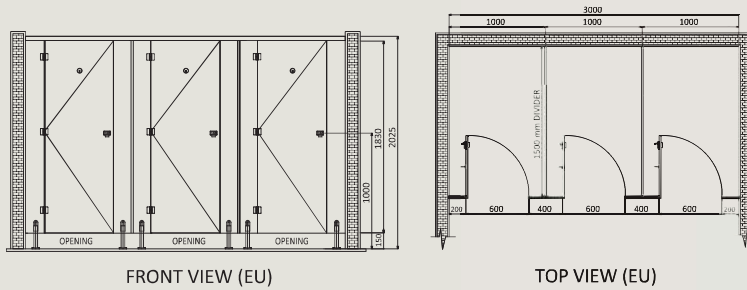

CU-CORNER UNIT

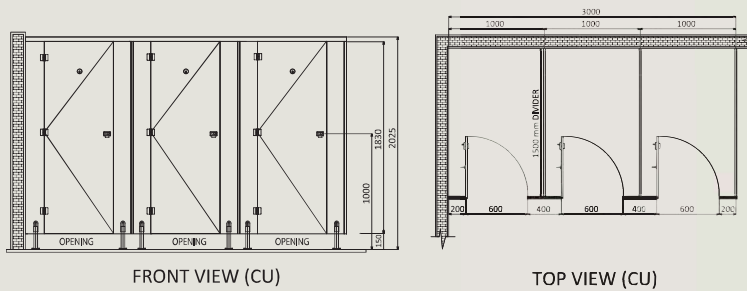

HARDWARE FIXING DETAILS

The adjustable foot that supports the pilasters is made from stainless steel (Grade 304) and its base is anchored to the floor with nylon plugs, inserted into ground with stainless steel screws. Aluminum U-channels are attached with the divider panel to the wall as well as the mid panel. There is a ground clearance of 150 mm. Stainless steel top rail with panel tube holder is used to fix the pilasters at the top with the arrangement of tabular holder and wall bracket. Stainless steel corner connectors are provided for imparting extra support to the restroom cubicle of L-shaped system. Further doors are incorporated with the noise deaftening tape to reduce the noise effect.

HARDWARE DETAILING

Each restroom cubicle is equipped with the following set of hardware fittings:

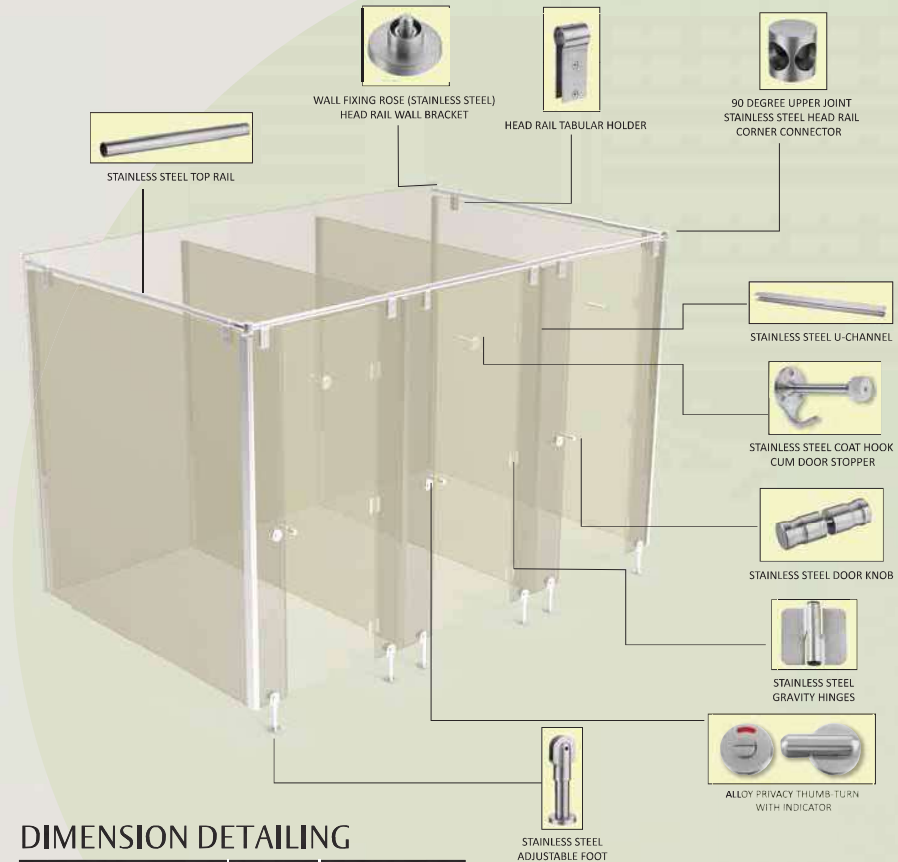

DIMENSION DETAILING

Standard Dimensions	General (mm)	Physically Challenged (mm)
Width of cubicle	1000	1500
Depth of cubicle	1500	1750
Height of entire cubicle	2025	2025
Width of door	600	900
Height of door	1830	1830
Ground clearance	150	150

Note:

- Classique's Evergreen comes with stainless steel (Grade 304) top rail arrangement
- On special demand, overall height of Classique's Evergreen restroom cubicle can be increased up to 2100 mm

CLASSIQUE- INVINCIBLE

Experience Classique collections another style-invincible, developed from 12 mm multi-layer high pressure Compact Laminate to give unparalleled performance and a stainless steel top rail for providing extra strength and stability. This 12 mm shoe box up model replaces the standard adjustable foot with a cleaner stainless steel box, located at the bottom to provide a clean line design. Rest of the hardwares like hinges, locks, door knobs and coat hooks are also produced in stainless steel. Thus, 12 mm shoe box up model is the perfect selection for your restroom space designing.



Stainless Steel Shoe Box Up



Stainless Steel Gravity Hinge



Head Rail Tubular Holder



Alloy Privacy Thumb Turn

EU-ENCLOSED UNIT

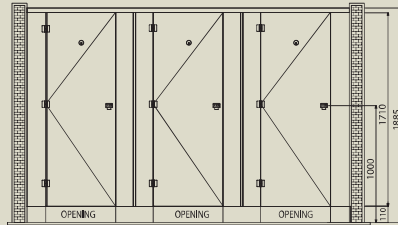

FRONT VIEW (EU)

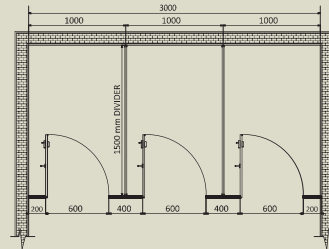

TOP VIEW (EU)

CU-CORNER UNIT

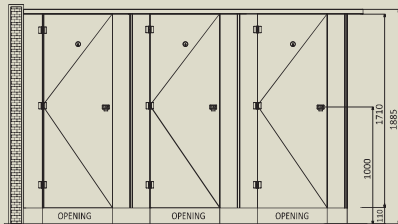

FRONT VIEW (CU)

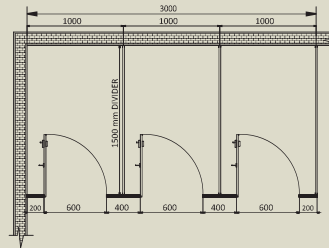

TOP VIEW (CU)

HARDWARE FIXING DETAILS

All pilasters are supported by L-bracket with floor anchor bolt. The L-bracket is concealed with stainless steel flat box up of up to 100 mm height. The stainless steel shoe box up is available in SS Grade 304 and 316 options. The divider panels are fixed onto the wall with stainless steel (Grade 304) U-channel section and SS Grade 304 screw inserts. Further all pilasters are fixed with a stainless steel (Grade 304) top rail at the top and doors are incorporated with the noise deafenin tape to reduce the noise effect.



HARDWARE DETAILING

Each restroom cubicle is equipped with the following set of hardware fittings:

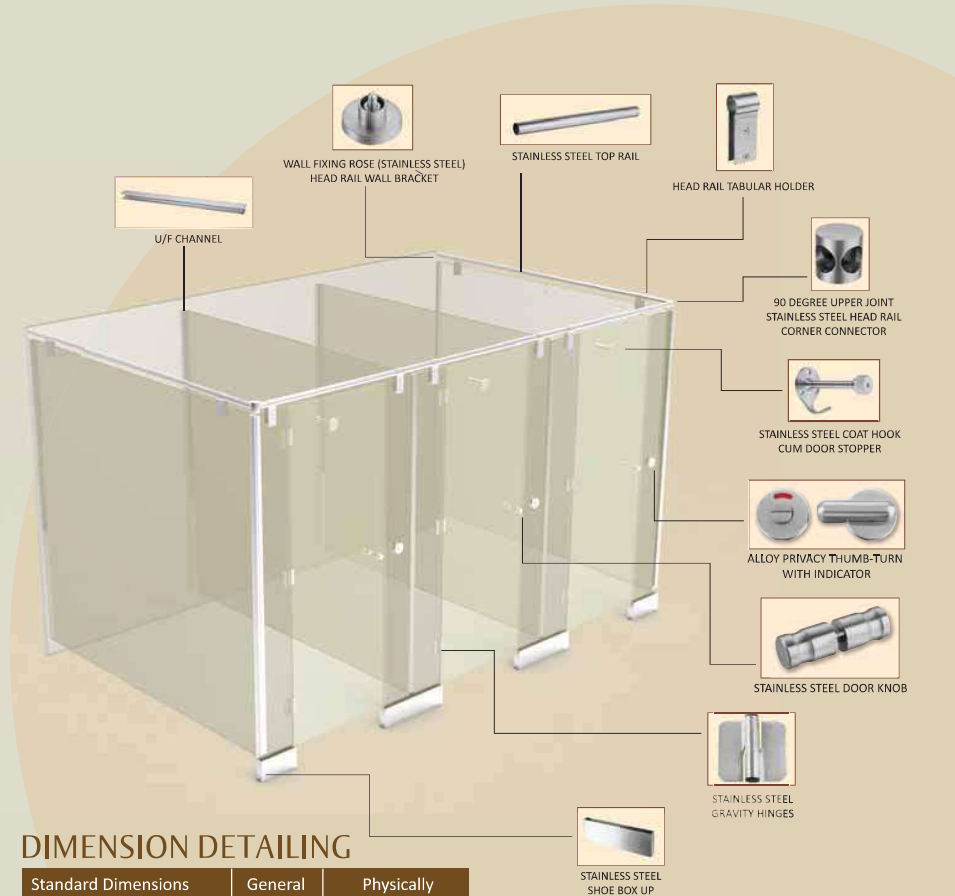

DIMENSION DETAILING

Standard Dimensions	General (mm)	Physically Challenged (mm)
Width of cubicle	1000	1500
Depth of cubicle	1500	1750
Height of entire cubicle	1885	1885
Width of door	600	900
Height of door	1710	1710
Ground clearance	110	110

Note:

- Invincible (12 mm, shoe box up) models come with stainless steel (Grade 304) top rail arrangement
- Invincible (12 mm, shoe box up) model is also available with stainless steel sliding and aluminum top rail fittings
- Shoe box up and adjustable foot are available in two options-stainless steel Grade 304 and 316
- On special demand, overall height of restroom cubicle can be increased up to 2100 mm

CLASSIQUE-GRANDEUR

Give your restroom space the feel of eternal magnificence with Classique's 18 mm shoe box up series-Grandeur. Formulated by using 18 mm thick Compact Laminate to provide greater strength to the cubicle setup because of which the top rail arrangement becomes avoidable. Therefore, its composition creates a clear space at the top and user's height doesn't become a constraint. An inspiring range of restroom cubicles especially built for providing higher durability and easier height adjustments. Its easy to operate height adjustments are hidden inside the stainless steel box up, located at the foot of each pilaster. Thereby making it a truly adaptable system that can vary in height to suit the site's requirements. This model is recommended for airports, commercial complexes, sports clubs, stadiums and gyms as it is highly in demand for people who are tall.



Alloy Privacy Indicator



Stainless Steel Gravity Hinge

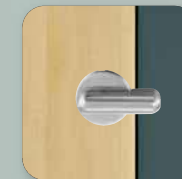

Alloy Privacy Thumb Turn



Stainless Steel Shoe Box Up

EU-ENCLOSED UNIT

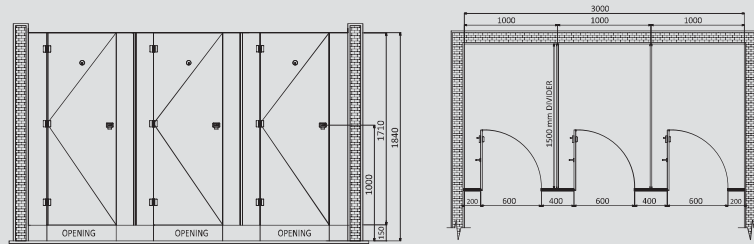

FRONT VIEW (EU)

TOP VIEW (EU)

CU-CORNER UNIT

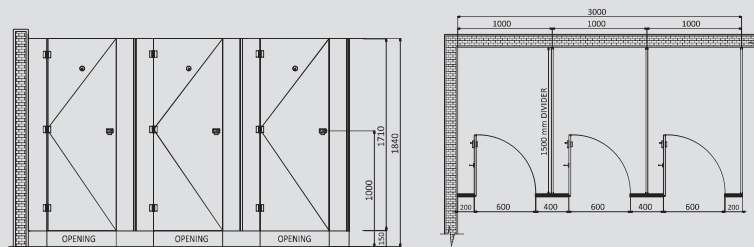

FRONT VIEW (CU)

TOP VIEW (CU)

HARDWARE FIXING DETAILS

All pilasters are supported by L-bracket with floor anchor bolt which is concealed with stainless steel flat box up height of up to 110 mm. The stainless steel box up is available in SS Grade 304 and 316 options. The intermediate panels are fixed onto the wall with stainless steel (Grade 304) U-channel section and SS 304 screw inserts.



HARDWARE DETAILING

Each restroom cubicle is equipped with the following set of hardware fittings:

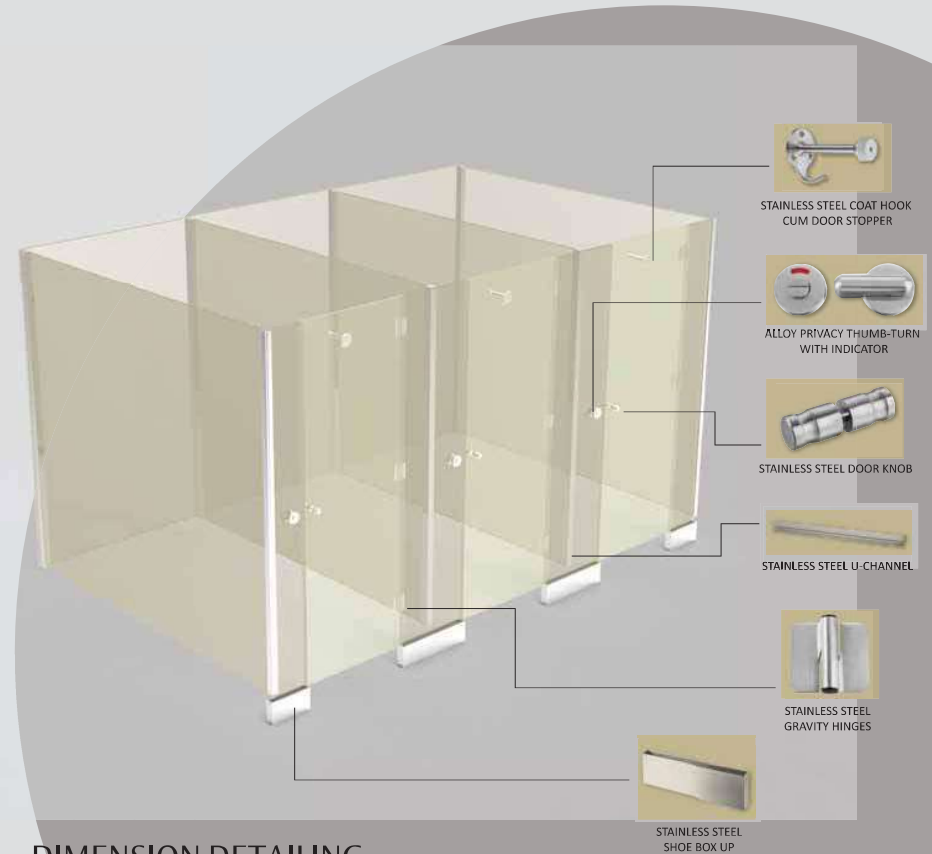

DIMENSION DETAILING

Standard Dimensions	General (mm)	Physically Challenged (mm)
Width of cubicle	1000	1500
Depth of cubicle	1500	1750
Height of entire cubicle	1840	1840
Width of door	600	900
Height of door	1710	1710
Ground clearance	110	110

Note:

- Only Classique's 18 mm box up series-Grandeur is available without the top rail arrangement.
- The shoe box up model and adjustable foot are available in two options-stainless steel Grade 304 and 316
- On special demand, overall height of restroom cubicle can be increased up to 2100 mm

CLASSIQUE- VERSATILE

Classique's new variant-Versatile is developed for providing higher endurance and spectacular design.

Magnificent design united with great functional features makes it an innovative restroom series offering uncompromised quality at an economical price along with extraordinary benefits. Engineered with 12mm thick high pressure Compact Laminate, this model comes with the combination of stainless steel hardware with extruded anodised aluminum top rail and fixing channels. Thus, it's a valuable choice for users who desire a highly adaptable restroom space, preferred across the globe for its budget effective product detailing and matchless quality.



Aluminium Top Rail



Alloy Privacy Indicator



Stainless Steel Adjustable Foot



Stainless Steel Gravity Hinge

EU-ENCLOSED UNIT

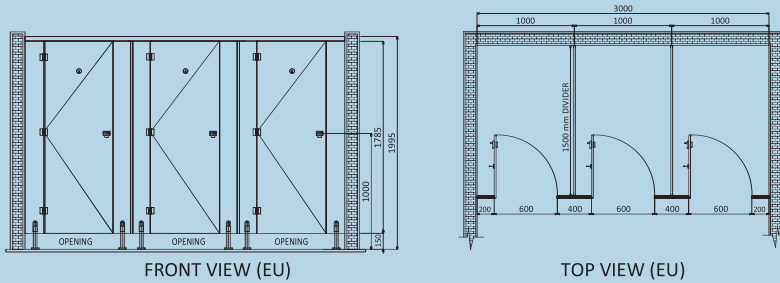

CU-CORNER UNIT

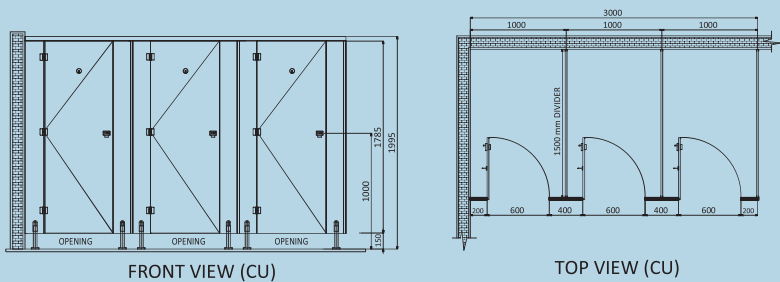

HARDWARE FIXING DETAILS

The adjustable foot that supports the pilasters is made from stainless steel (Grade 304) and its base is anchored to the floor with nylon plug, fixed into ground with stainless steel screws. There is a ground clearance of 150 mm. Aluminum U-channels are used to attach with the divider panels to the wall as well as the mid panel with stainless steel (Grade 304) screw inserts. Aluminum top rail coated in stainless steel colour is used to fix the pilasters at the top. Doors are incorporated with the noise deafening tape to reduce the noise effect. All other fittings like hinges, coat hook, adjustable foot and lock set/latch indicator is manufactured in stainless steel



HARDWARE DETAILING

Each restroom cubicle is equipped with the following set of hardware fittings:

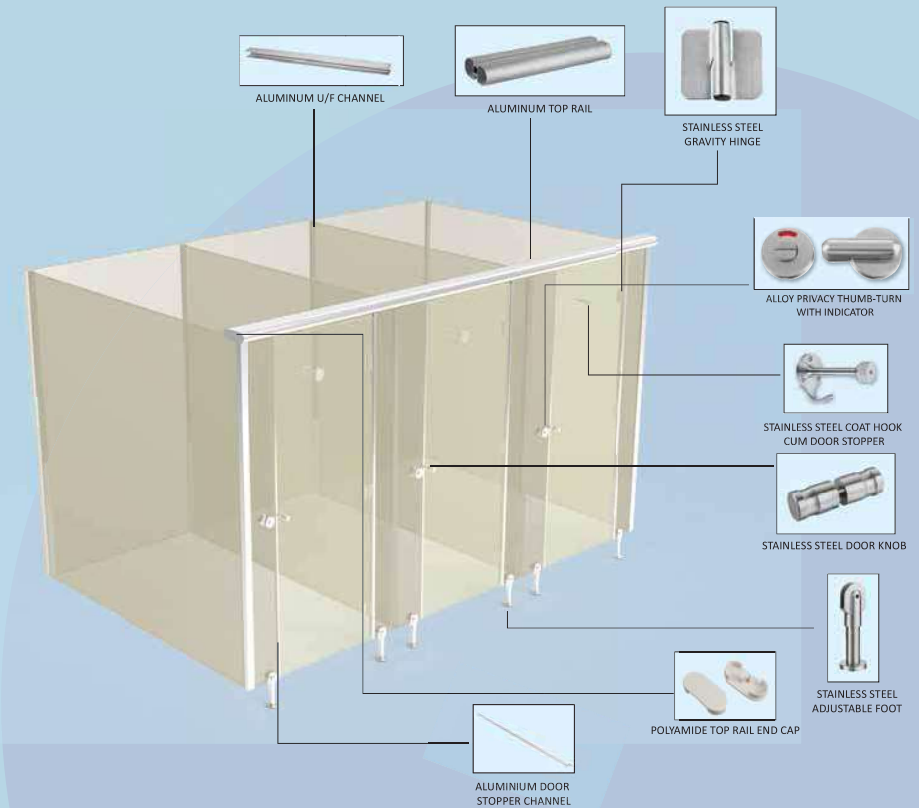

DIMENSION DETAILING

Standard Dimensions	General (mm)	Physically Challenged (mm)
Width of cubicle	1000	1500
Depth of cubicle	1500	1750
Height of entire cubicle	1995	1995
Width of door	600	900
Height of door	1785	1785
Ground clearance	150	150

VIBRANCE

For the everlasting fresh look, Vibrance series offers the perfect combination of functionality and design. Vibrant colours of Compact Laminate accentuated in varied colours of polyamide fittings, is one of the unique feature of this series.

This series brings maximum solution for high wear and tear prone areas like hostels and institutes which require robust build quality. To cater to different architectural layouts and traffic volumes, Vibrance series is equipped with models which can be used-with and without pole construction (Depending on the wear and tear) and for retrofit projects where restroom space comprises of existing walls.

To complement our 12 mm thick Compact Laminate range of different woodgrains and solid colours, hardware fittings for Vibrance series are available in Black, Grey, Cream, Rustic Brown & Champagne colours. With myriad design options this series can be classified into 4 models.

- **Rage**
- **Serene**
- **Elegance**
- **Splendid**



VIBRANCE RAGE

Rev up the elegance of your washrooms.

Greenlam Sturdo brings you, Vibrance Rage, a new addition to the Vibrance collection, crafted to redefine the grace of your restrooms. The unmatched blend of functionality and classically, these contemporary cubicles are prepared from extruded anodized aluminum hardware studded with urbane colors and Gun Metal finish. To enhance the exquisiteness, all doors are 12 mm thick with chamfered edges. So, go on and make your washrooms, a masterpiece of exclusivity. Available in 2 earthy shades: Rustic Brown & Champaigne.

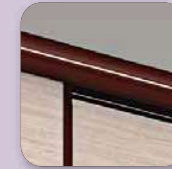

Aluminium Top Rail



Door Knob & Indicator



Bottom Pedestal



Anodized Aluminium Door Stopper Channel

HARDWARE COLOUR RANGE



Rustic Brown



Champaigne

EU-ENCLOSED UNIT

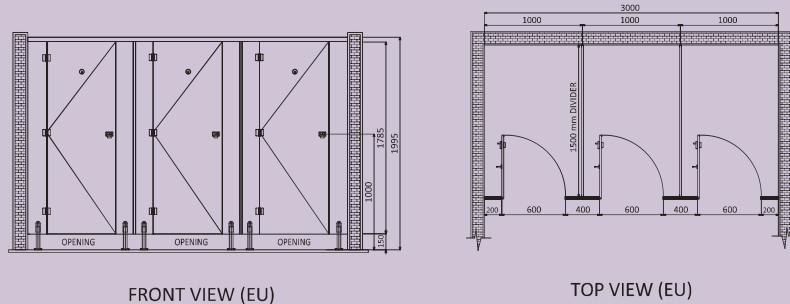

FRONT VIEW (EU)

TOP VIEW (EU)

CU-CORNER UNIT

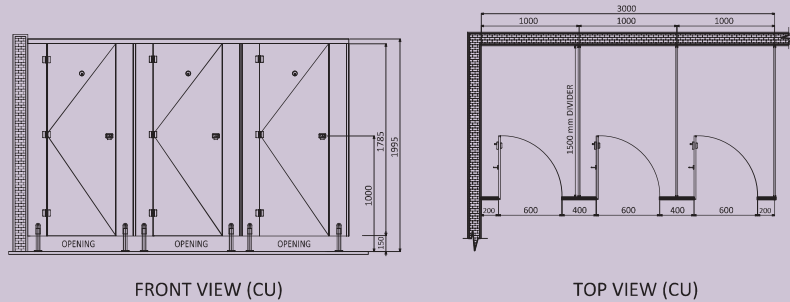

FRONT VIEW (CU)

TOP VIEW (CU)

HARDWARE FIXING DETAILS

The adjustable foot that supports the pilasters is made from corrosion resistant Aluminum and its base is anchored to the floor with nylon plug inserted into ground with stainless steel screws. There is a ground clearance of 150 mm. Aluminum U-channels are used to attach the divider panel with stainless steel (Grade 304) screw inserts to the wall as well as the mid panel. Aluminum top rail (Grade 6063-T5 Alloy) is used to fix the pilasters at the top. Door stopper channel provides the non-rebating doors and connecting panels with extra ordinary look. Further the doors are incorporated with the noise deafening tape to reduce the noise effect.



HARDWARE DETAILING

Each restroom cubicle is equipped with the following set of hardware fittings:

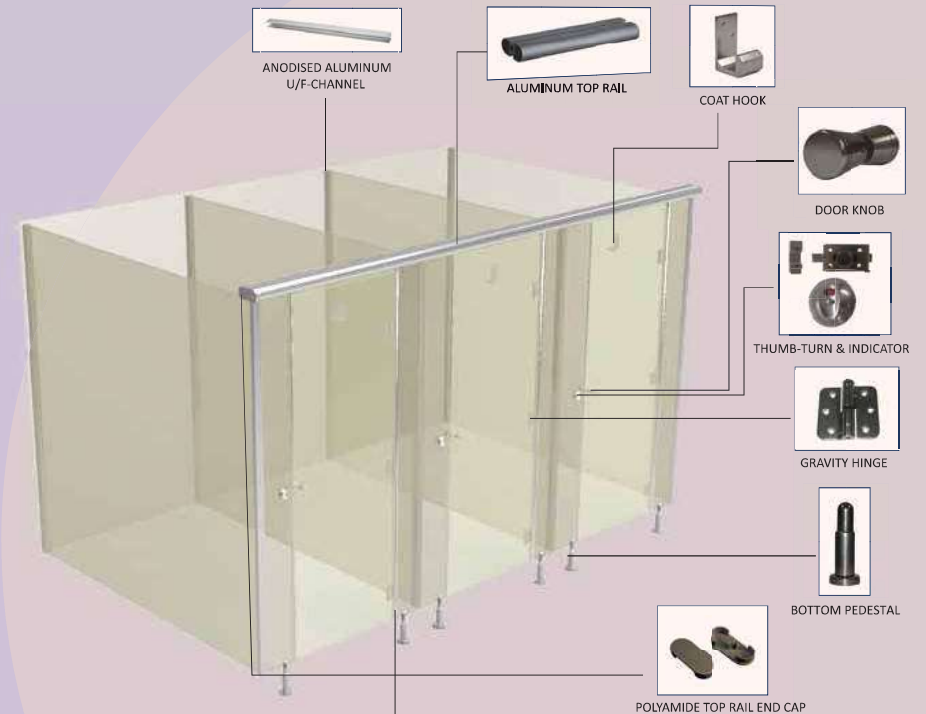

DIMENSION DETAILING

Standard Dimensions	General (mm)	Physically Challenged (mm)
Width of cubicle	1000	1500
Depth of cubicle	1500	1750
Height of entire cubicle	1995	1995
Width of door	600	900
Height of door	1785	1785
Ground clearance	150	150



ALUMINIUM DOOR STOPPER CHANNEL

VIBRANCE-SERENE

Presenting serenity and simplicity at its finest, the Vibrance's Serene series is the typical model for restroom cubicles which provide easy construction and high durability. The Serene cubicle model is aesthetically designed with the extruded anodised aluminum top rail and polyamide hardware, for giving a clean and a lean look to the restroom setup. Its intermediate panel comprises of one undivided piece and has no joints in between. All pilasters as well as doors are 12 mm thick with chamfered edges. Thus, for those who like minimalistic designs, Serene is the answer.



Aluminium Top Rail



Door Knob & Privacy Indicator



Nylon Coated Adjustable Foot



Anodized Aluminium Door Stopper Channel

HARDWARE COLOUR RANGE



Black



Grey



Cream

EU-ENCLOSED UNIT

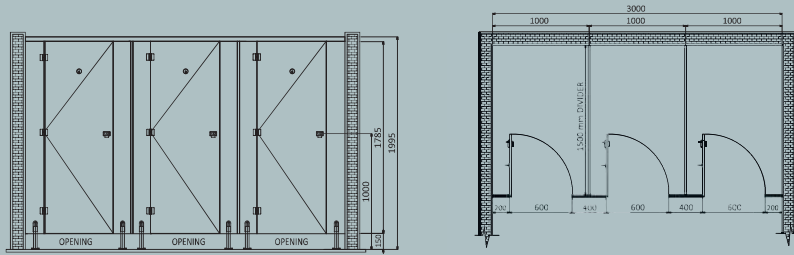

FRONT VIEW (EU)

TOP VIEW (EU)

CU-CORNER UNIT

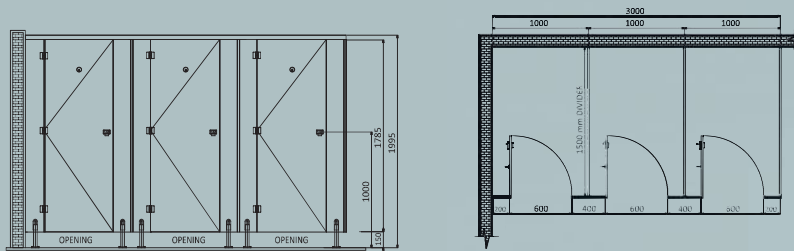

FRONT VIEW (CU)

TOP VIEW (CU)

HARDWARE FIXING DETAILS

The adjustable foot that supports the pilasters is made from corrosion resistant nylon (Polyamide 6) and its base is anchored to the floor with nylon plug inserted into ground with stainless steel screws. There is a ground clearance of 150 mm. Aluminum U-channels are used to attach the divider panel with stainless steel (Grade 304) screw inserts to the wall as well as the mid panel. Aluminum top rail (Grade 6063-T5 Alloy) is used to fix the pilasters at the top. Door stopper channel provides the non-rebating doors and connecting panels with extra ordinary look. Further the doors are incorporated with the noise deafening tape to reduce the noise effect.

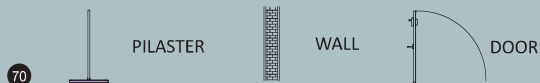

HARDWARE DETAILING

Each restroom cubicle is equipped with the following set of hardware fittings:

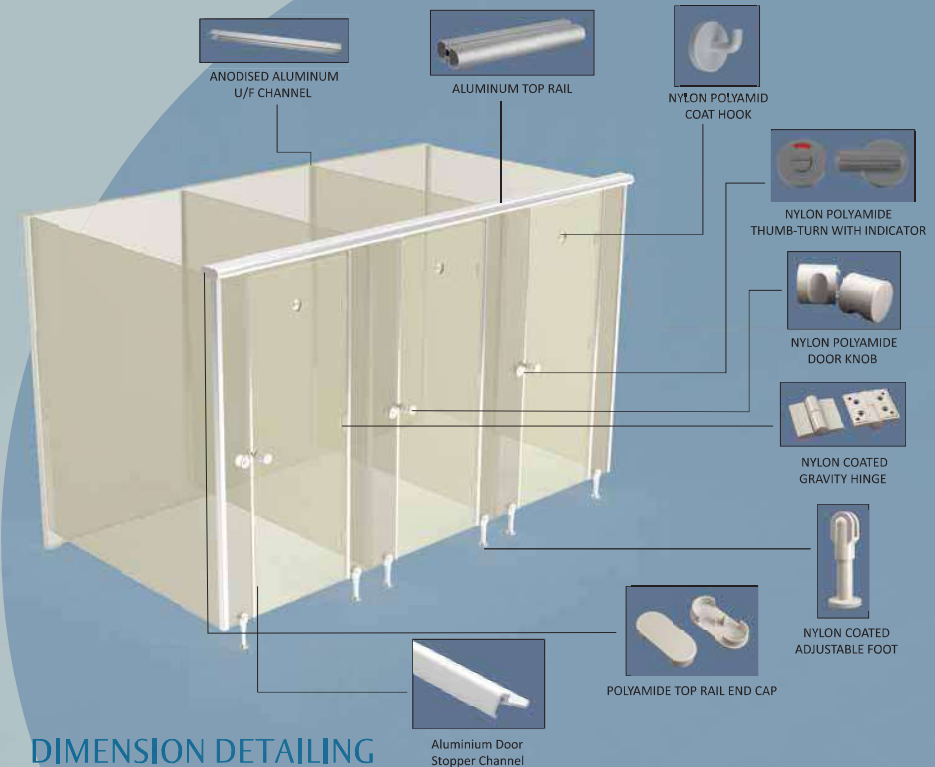

DIMENSION DETAILING

Standard Dimensions	General (mm)	Physically Challenged (mm)
Width of cubicle	1000	1500
Depth of cubicle	1500	1750
Height of entire cubicle	1995	1995
Width of door	600	900
Height of door	1785	1785
Ground clearance	150	150

VIBRANCE- ELEGANCE

When restrooms are subjected to heavy footfall and usage, the chances of damage due to extreme wear and tear become greater. Thus, add a touch of elegance and class to your restroom space with a model which offers sturdiness and durability. The core strength of this model lies in its robust aluminum pole construction which makes it suitable for heavy traffic areas and high vandal prone environment like multiplexes, commercial malls, etc. The pole construction not only provides better strength but also adds to the design by breaking the monotony of single colour usage.



Aluminum Top Rail



Nylon Polyamide Door Knob & Indicator



Nylon Coated Adjustable Foot



Aluminum Circular Pole

HARDWARE COLOUR RANGE



Black



Grey



Cream

EU-ENCLOSED UNIT

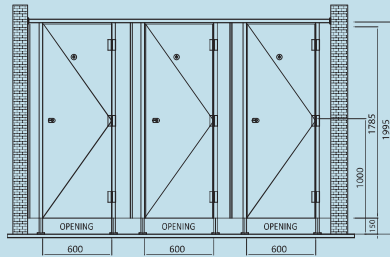

FRONT VIEW (EU)

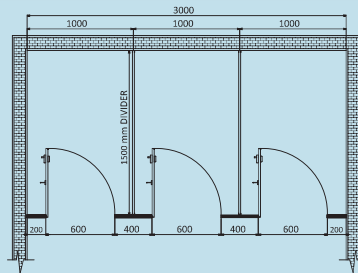

TOP VIEW (EU)

CU-CORNER UNIT

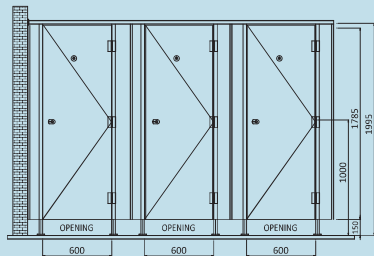

FRONT VIEW (CU)

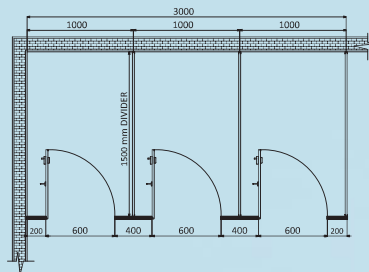

TOP VIEW (CU)

HARDWARE DETAILING

Each restroom cubicle is equipped with the following set of hardware fittings:

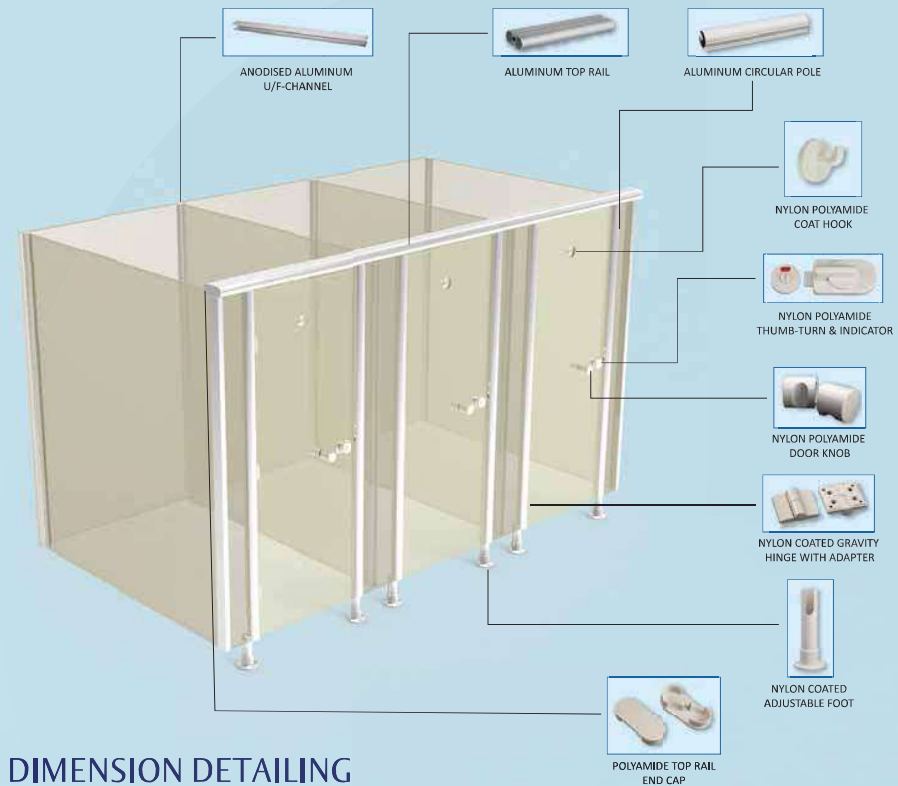

HARDWARE FIXING DETAILS

The foot that supports the pilasters is made from corrosion resistant aluminum and its base is anchored to the floor with nylon plug inserted into ground with stainless steel screws. There is a ground clearance of 150 mm. Aluminum U-channels are used to fix the divider panel onto the wall with stainless steel (Grade 304) screw inserts to the wall as well as the mid panel. Aluminum top rail (Grade 6063-T5 Alloy) is used to fix the pilasters at the top. Door stopper channel provides the non-rebating doors and connecting panels with extra ordinary look. Further the doors are incorporated with the noise deafening tape to reduce the noise effect.



DIMENSION DETAILING

Standard Dimensions	General (mm)	Physically Challenged (mm)
Width of cubicle	1000	1500
Depth of cubicle	1500	1750
Height of entire cubicle	1995	1995
Width of door	600	900
Height of door	1785	1785
Ground clearance	150	150

VIBRANCE- SPLENDID

A combination of style and stability, Vibrance's Splendid is ideal for renovation projects, using existing intermediate brick walls. With the usage of existing intermediate brick walls this model fits in perfectly as it suffices only the door requirements. Thus, Splendid replaces the traditionally used door setup with contemporary looking masonry walls. This model comes with a 12 mm thick Compact Laminate doors in varied colours and designs along with aluminum and nylon polyamide (Grade 6) fittings.



Nylon Polyamide Thumb-Turn & Indicator

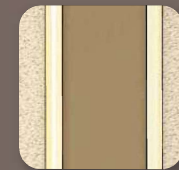

Aluminium D-Post Channel



Nylon Polyamide Coat Hook



Nylon Coated Thumb-Turn

HARDWARE COLOUR RANGE



Black



Grey



Cream

EU-ENCLOSED UNIT

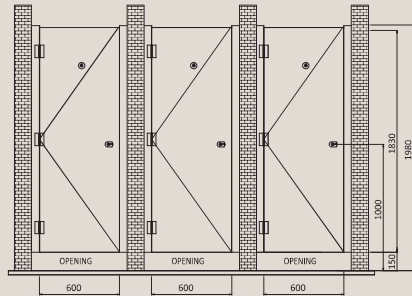

FRONT VIEW (EU)

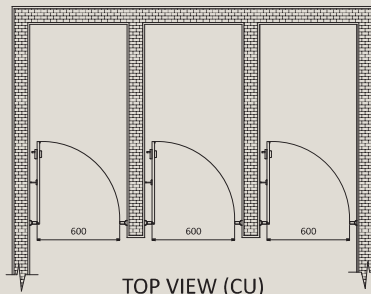

TOP VIEW (CU)

HARDWARE FIXING DETAILS

Doors are supported by a 31.1 mm diameter D-shape aluminum vertical pole. Hardware fittings are made of nylon polyamide (Grade 6) material. Aluminum D-post channels are fixed to the wall with stainless steel (Grade 304) screws and wall plugs. Aluminum vertical poles are incorporated with the noise deafening tape to reduce the noise effect. Further doors are attached to the poles by an arrangement of hinge adaptors and hinges.



HARDWARE DETAILING

Each restroom cubicle is equipped with the following set of hardware fittings:

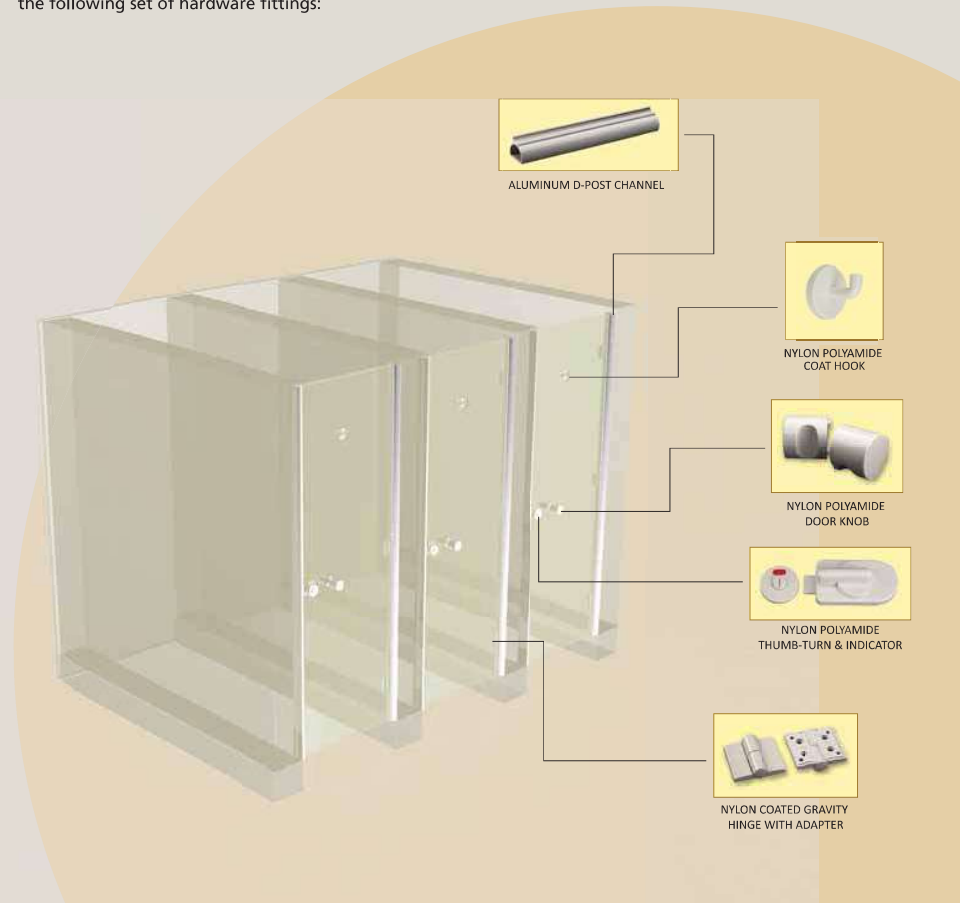

DIMENSION DETAILING

Standard Dimensions	General (mm)	Physically Challenged (mm)
Door width of cubicle	600-900	As this model only uses door applications the dimensions for physically challenged setup will depend on the site's walls
Height of entire cubicle	1980	
Height of door	1830	
Ground clearance	150	150



PRESENTING



LOCKER SYSTEMS

UNLOCKING THE WORLD'S BEST LOCKER SYSTEMS

Greenlam Sturdo lockers open up a new generation of locker rooms. A world of ultra-modern and exceptionally smart storage solutions made using Greenlam Compact laminates.

Brilliantly designed and widely durable, they are suitable for high humidity areas such as fitness clubs, sauna rooms, swimming pools, retail environments and sports centers.

Available in a wide range of styles, sizes, configurations and colors to achieve a perfect match with your services and interior designs. These systems are extra-tough, environment-friendly, easy to install and even easier to use.

What's more, they come with unique Anti-Bacterial property that makes them a superb choice for hygiene concern areas.

KEY HIGHLIGHTS

- Made using Anti-Bacterial compact laminates (3 mm and 9 mm)
- Made using heavy duty Aluminium channel
- Provision of 3 locking systems
 - Customer lock
 - Inbuilt lock
 - Keyless lock

Comes with an option of different base mechanism

- Stainless Steel leg base
- Compact Laminate base
- Concrete base





ONE LOCKER MANY BENEFITS

- Greenlam Sturdo locker systems offer excellent hygiene properties as these are made using path-breaking Anti-Bacterial Compact Laminates
- Effectively restrain the growth of bacteria
- Highly resistant to wear and tear, ideal for application where frequent cleaning is necessary
- With greater dimensional stability and flatness
- Easy to maintain, can clean stains by water or liquid detergent
- Exceptionally durable and cost-effective
- Excellent scratch resistance, acid resistance, alkali resistance, corrosion resistance and more
- Suitable for heavy-duty use
- Discoloration-resistant



LOCKERS

2 TIER

1 TIER



LOCKERS

3 TIER



4 TIER



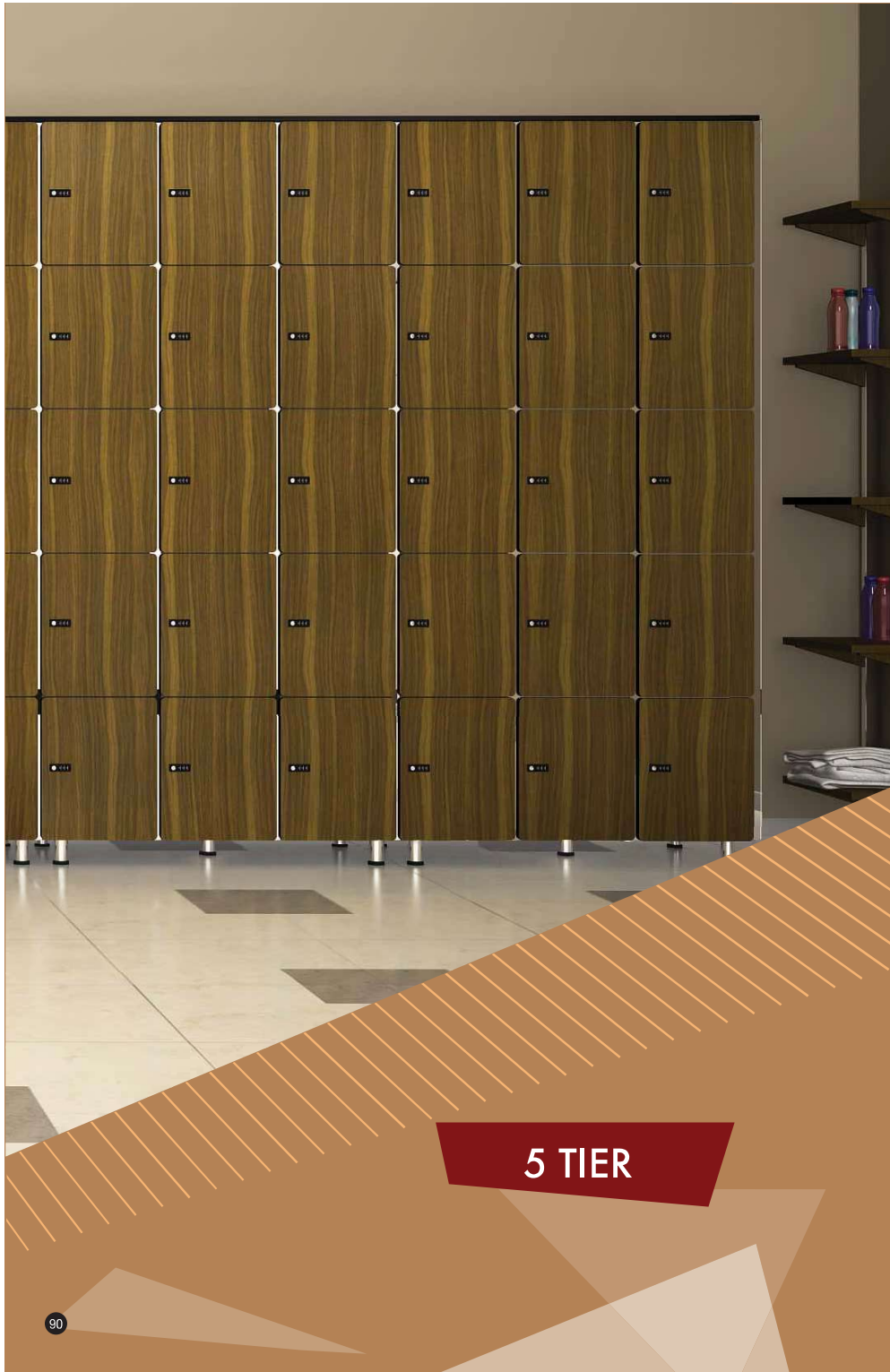

5 TIER

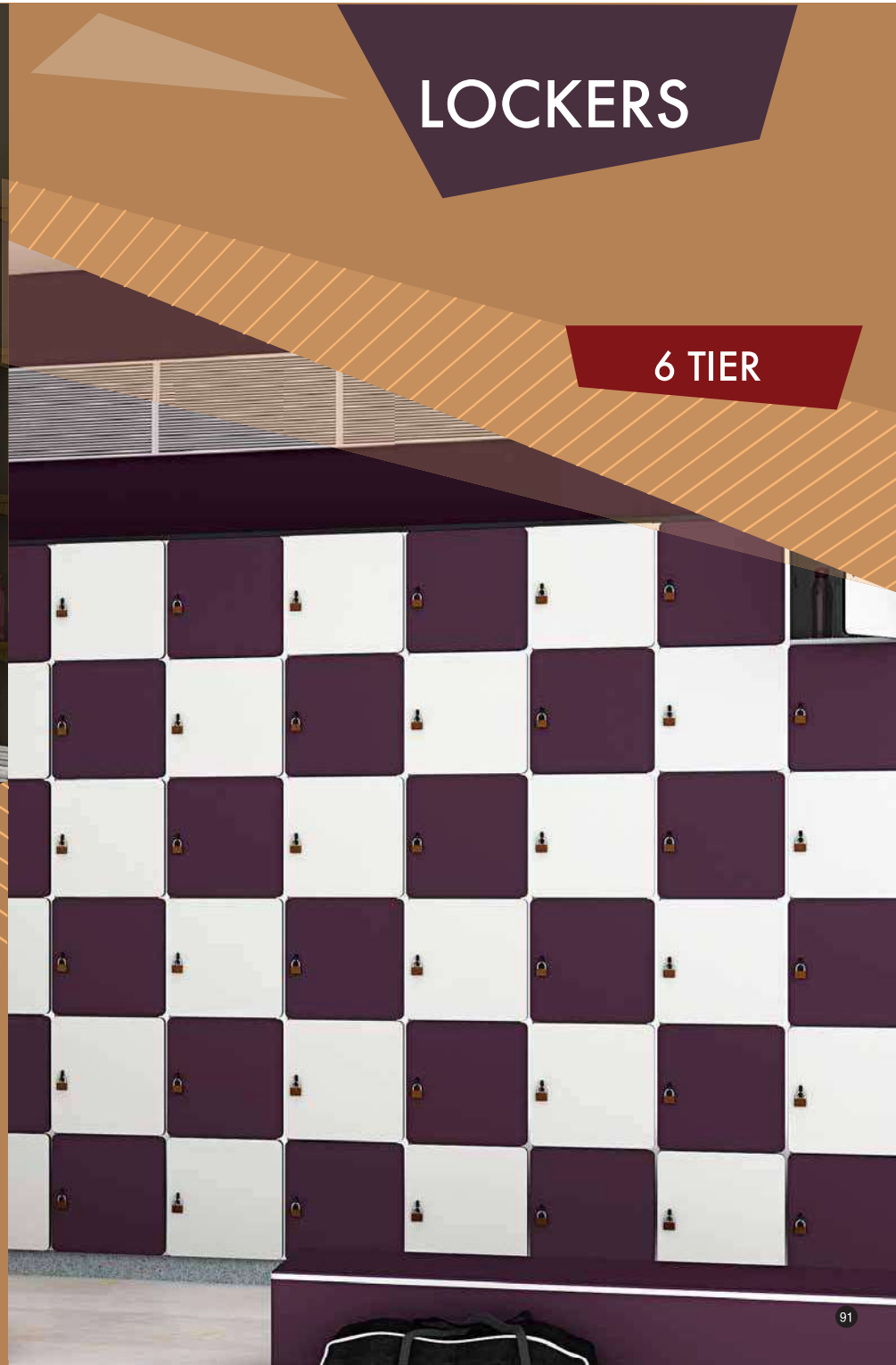

LOCKERS

6 TIER

LOCKERS

Z TYPE



LOCKER COMPONENTS

HINGES

Greenlam sturdo locker door hinges are of a patented, vandal-proof design that is integrated into the aluminum frame and carries a lifetime warranty. The door opens at a wide 175 degree angle for easy access and each locker is self-ventilated around the perimeter of the door where it meets the frame.



HINGE

DOORS, WALLS AND PARTITIONS

Greenlam sturdo locker doors, walls and partitions are made from solid phenolic HPL, an environment friendly but extremely durable material manufactured under high-pressure.

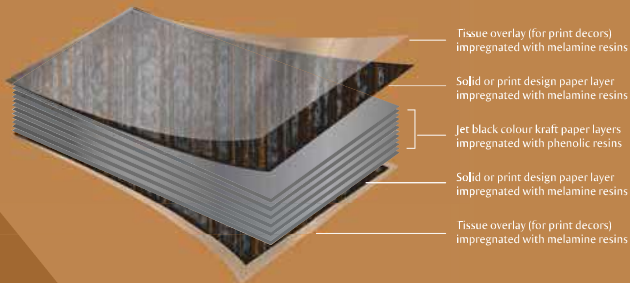

STRUCTURAL CHANNELS



Aluminum Profile

Greenlam sturdo locker systems mutually integrated frames, threaded connectors and "plug & screw" assembly eliminates the need for glue or permanent fastenings. The result is a completely modular system: less expensive to ship, easy to install, ideal for retrofit and remodel and can be easily disassembled and reassembled with no compromise to the materials.

BASE MECHANISM



STAINLESS STEEL LEGS



SKIRTING OF COMPACT LAMINATE

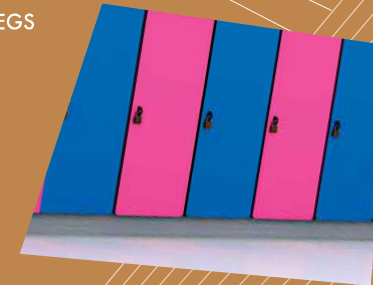

CONCRETE BASE

LOCK OPTIONS AVAILABLE



CUSTOMER LOCK



KEY LESS LOCK(NUMERIC)



KEY LOCK INBUILT

OUTLINE

1 TIER

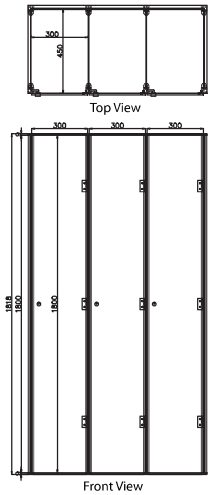

DIMENSION DETAILING

Standard Dimensions	Size (mm)
Width of Locker	300
Depth of Locker	450
Height of Locker	1800

2 TIER

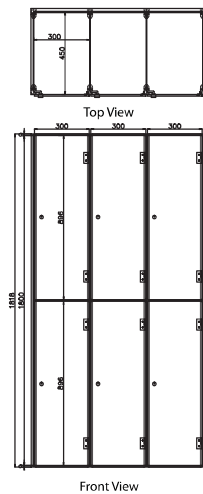

DIMENSION DETAILING

Standard Dimensions	General (mm)
Width of Locker	300
Depth of Locker	450
Height of Locker	895

3 TIER

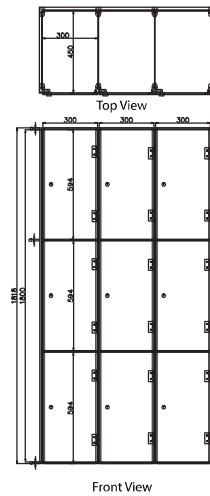

DIMENSION DETAILING

Standard Dimensions	Size (mm)
Width of Locker	300
Depth of Locker	450
Height of Locker	594

4 TIER

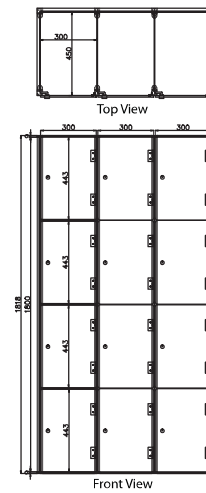

DIMENSION DETAILING

Standard Dimensions	Size (mm)
Width of Locker	300
Depth of Locker	450
Height of Locker	443

5 TIER

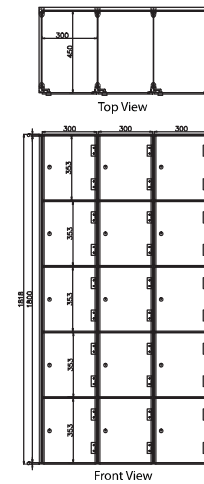

DIMENSION DETAILING

Standard Dimensions	Size (mm)
Width of Locker	300
Depth of Locker	450
Height of Locker	353

6 TIER

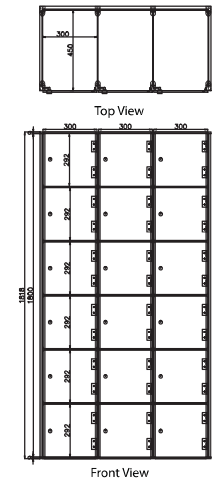

DIMENSION DETAILING

Standard Dimensions	Size (mm)
Width of Locker	300
Depth of Locker	450
Height of Locker	292

Z TYPE

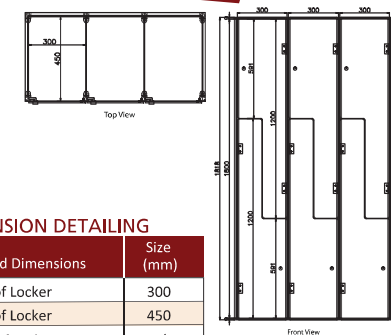

DIMENSION DETAILING

Standard Dimensions	Size (mm)
Width of Locker	300
Depth of Locker	450
Height of Locker	1200/591

PRIVY DIVIDER PANELS

Give a new meaning to your restroom space with vibrant coloured Privy Divider Panel laminates (urinal partitions) coupled with rust resistant stainless steel fittings. Composed with superior product features to provide greater privacy and hygiene to the users. The urinal partitions are manufactured using 12 mm thick Compact Laminates, in accordance to IS-2046-199/BSEN-438(1)-91. Further its product composition consists of one undivided piece, chamfered edges with no joints in between which provides a cleaner and well structured look to your restroom space. Equipped with the comprehensive series of conventional designs, Privy Divider Panels are available in exciting colours and shapes and promises to give your restroom space an exquisite yet organised look.



HAND HOLDS

Ergonomically designed, Hand Holds collection is an arrangement of flexible tubes and connectors that provides customised and creative designs for guide railings, support bars, handrails and stairways. These products are produced of anti-corrosive nylon fixtures along with high quality aluminum fittings. To provide extra support and safety, vertical and horizontal application options along with left and right handed product versions are made available. It gives utmost advantages like hygiene, easy maintenance, anti-static surface and durability.

These heavy duty grab bars are manufactured in accordance to ADA (Americans with Disabilities Act, 1990) guidelines for providing stability and the extra assistance to the physically disabled. They can be adjusted as per your needs and are available in three standard colours-black, grey and cream and in five distinct models.

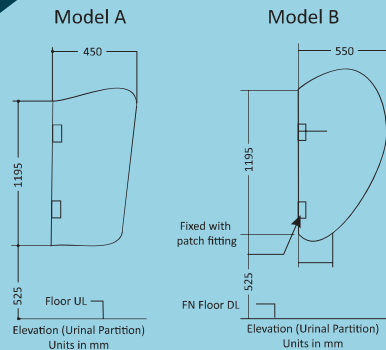

DIMENSIONS

- Total Height: 1000-1200 mm
- Depth: 450-550 mm
- Gap from ground floor: 500-600 mm

HARDWARE DETAILING

Each divider panel is equipped with the following hardware fittings:

- Stainless steel L-clamp is used to attach the divider to the wall

HARDWARE FIXING DETAILS

Stainless steel L-clamp hardware fittings along with SU-304 screws are used to fix the urinal partitions on the wall.



Hardware detailing

- Wall plugs
- Screws

Hardware fixing details

- Wall plugs and screws are provided for fixing the grab bars

Hardware Colour Options



Z Safety Support Bar



L Safety Support Bar



Horizontal & Vertical Safety Support Bar



Grab Rail with Intermediate Wall Support

Annexure

KIDDIE WORLD

Bill of Quantities:Toilet Block Work

S. No.	ITEM DESCRIPTION	APPROVED MAKE	BASIC PRICE	REMARKS FLOOR	QUANTITY TOTAL	UNIT	RATE	AMOUNT
1.00	Partitions & Associated Works							
1.00	Toilet Cubicle							
	<p>Supplying & fixing in position GREENLAM STURDO, KIDDIE WORLD Toilet Cubicle (of following standard dimension which includes 600mm door size width) made of heat, bacteria, water, chemical, scratch and impact resistant 12mm thick solid compact laminate panels including doors, pilasters & intermediate panels finished with approved texture/shade as per the detail drawings & as per IS 2046 (Indian Standard). The compact lam should have Green Guard Certificate.It should be anti bactrial (certified by Shri Ram Test House)</p> <p>This also includes providing and fixing in position necessary hardware made out of Stainless steel304 GRADE: (1) Door Knob, (2) Gravity hinges, (3) Thumb turn indicators, (4) Coat Hooks, (5) U-Channels, (6) Shoe box (7) Shoe box side cover (8) L bracket (Floor anchor) (9) Noise Deafening Tape etc. (9) Screws (stainless steel in 304 Grade with satin finish) & wall Plugs.</p> <p>The all pilaster are supported by L bracket with floor anchor bolt, The L bracket is concealed with stainless steel flat box up of up to 100 mm height. The stainless steel shoe box is available in SS 304 & 316 Grade options. The divider panels are fixed on to the wall with stainless steel U channel section and SS Grade 304 screw inserts..</p>	Kiddie World model of Greenlam Sturdo						
1.01	Toilet Cubicle with standard dimension Front 12mm thick with 1500mm Height x 1000mm Width (Door Size 600mmx1250mm) ,Partition 12mm thick 1500mm Depth x 1300mm height (Including gap of 100mm), which includes 600mm door size width). L type					Nos		
1.02	Toilet Cubicle I-Shape (Front Partition) with standard dimension of 12mm thick ,1500mm Height x 1000mm Width which includes 600 mm x 1250mm door size width).					Nos		
	All aspects specified by the manufactures, Greenlam Sturdo Classique Invincible Series.					Nos		
	* Raw silk finish is available on special demand.							

Annexure

CRAZY BALLS

Bill of Quantities:Toilet Block Work

S. No.	ITEM DESCRIPTION	APPROVED MAKE	BASIC PRICE	REMARKS FLOOR	QUANTITY TOTAL	UNIT	RATE	AMOUNT
1.00	Partitions & Associated Works							
1.00	Toilet Cubicle							
	<p>Supplying & fixing in position GREENLAM STURDO, CRAZY BALLS Toilet Cubicle (of following standard dimension which includes 600mm door size width) made of heat, bacteria, water, chemical, scratch and impact resistant 12mm thick solid compact laminate panels including doors, pilasters & intermediate panels finished with approved texture/shade as per the detail drawings & as per IS 2046 (Indian Standard). The compact lam should have Green Guard Certificate.It should be anti bactrial (certified by Shri Ram Test House)</p> <p>This also includes providing and fixing in position necessary hardware made out of Stainless steel304 GRADE : (1) Door Knob, (2) Gravity hinges, (3) Thumb turn indicators, (4) Coat Hooks, (5) U-Channels, (6) Shoe box (7) Shoe box side cover (8) L bracket (Floor anchor) (9) Noise Deafening Tape etc. (9) Screws (stainless steel in 304 Grade with satin finish) & wall Plugs.</p> <p>The all pilaster are supported by L bracket with floor anchor bolt, The L bracket is concealed with stainless steel flat box up of up to 100 mm height. The stainless steel shoe box is available in SS 304 & 316 Grade options. The divider panels are fixed on to the wall with stainless steel U channel section and SS Grade 304 screw inserts..</p>	Crazy Balls model of Greenlam Sturdo						
1.01	Toilet Cubicle with standard dimension Front 12mm thick with 1500mm Height x 1000mm Width (Door Size 600mmx1250mm) ,Partition 12mm thick 1500mm Depth x 1300mm height (Including gap of 100mm), which includes 600mm door size width). L type					Nos		
1.02	Toilet Cubicle I-Shape (Front Partition) with standard dimension of 12mm thick ,1500mm Height x 1000mm Width which includes 600 mm x 1250mm door size width).					Nos		
	All aspects specified by the manufactures, Greenlam Sturdo Classique Invincible Series.					Nos		
	* Raw silk finish is available on special demand.							

PICKET FENCE

Bill of Quantities:Toilet Block Work

S. No.	ITEM DESCRIPTION	APPROVED MAKE	BASIC PRICE	REMARKS FLOOR	QUANTITY TOTAL	UNIT	RATE	AMOUNT
1.00	Partitions & Associated Works							
1.00	Toilet Cubicle							
	<p>Supplying & fixing in position GREENLAM STURDO, PICKET FENCE Toilet Cubicle (of following standard dimension which includes 600mm door size width) made of heat, bacteria, water, chemical, scratch and impact resistant 12mm thick solid compact laminate panels including doors, pilasters & intermediate panels finished with approved texture/shade as per the detail drawings & as per IS 2046 (Indian Standard). The compact lam should have Green Guard Certificate.It should be anti bactrial (certified by Shri Ram Test House)</p> <p>This also includes providing and fixing in position necessary hardware made out of Stainless steel304 GRADE : (1) Door Knob, (2) Gravity hinges, (3) Thumb turn indicators, (4) Coat Hooks, (5) U-Channels, (6) Shoe box (7) Shoe box side cover (8) L bracket (Floor anchor) (9) Noise Deafening Tape etc. (9) Screws (stainless steel in 304 Grade with satin finish) & wall Plugs.</p> <p>The all pilaster are supported by L bracket with floor anchor bolt, The L bracket is concealed with stainless steel flat box up of up to 100 mm height. The stainless steel shoe box is available in SS 304 & 316 Grade options. The divider panels are fixed on to the wall with stainless steel U channel section and SS Grade 304 screw inserts,</p>	Picket Fence model of Greenlam Sturdo						
1.01	Toilet Cubicle with standard dimension Front 12mm thick with 1600mm Height x 1000mm Width (Door Size 600mmx1250mm) ,Partition 12mm thick 1500mm Depth x 1300mm height (Including gap of 100mm), which includes 600mm door size width). L type					Nos		
1.02	Toilet Cubicle I-Shape (Front Partition) with standard dimension of 12mm thick ,1600mm Height x 1000mm Width which includes 600 mm x 1250mm door size width).					Nos		
	All aspects specified by the manufactures, Greenlam Sturdo Classique Invincible Series.					Nos		
	* Raw silk finish is available on special demand.							

ARCS

Bill of Quantities:Toilet Block Work

S. No.	ITEM DESCRIPTION	APPROVED MAKE	BASIC PRICE	REMARKS FLOOR	QUANTITY TOTAL	UNIT	RATE	AMOUNT
1.00	Partitions & Associated Works							
1.00	Toilet Cubicle							
	<p>Supplying & fixing in position GREENLAM STURDO, ARCS Toilet Cubicle (of following standard dimension which includes 600mm door size width) made of heat, bacteria, water, chemical, scratch and impact resistant 12mm thick solid compact laminate panels including doors, pilasters & intermediate panels finished with approved texture/shade as per the detail drawings & as per IS 2046 (Indian Standard). The compact lam should have Green Guard Certificate.It should be anti bactrial (certified by Shri Ram Test House)</p> <p>This also includes providing and fixing in position necessary hardware made out of Stainless steel 304 GRADE : (1) Door Knob, (2) Gravity hinges, (3) Thumb turn indicators, (4) Coat Hooks, (5) U-Channels, (6) Shoe box (7) Shoe box side cover (8) L bracket (Floor anchor) (9) Noise Deafening Tape etc. (9) Screws (stainless steel in 304 Grade with satin finish) & wall Plugs.</p> <p>The all pilaster are supported by L bracket with floor anchor bolt, The L bracket is concealed with stainless steel flat box up of up to 100 mm height. The stainless steel shoe box is available in SS 304 & 316 Grade options. The divider panels are fixed on to the wall with stainless steel U channel section and SS Grade 304 screw inserts,</p>	Arcs model of Greenlam Sturdo						
1.01	Toilet Cubicle with standard dimension Front 12mm thick with 1930mm Height x 1000mm Width (Door Size 600mmx1830mm) ,Partition 12mm thick 1550mm Depth x 1930mm height (Including gap of 100mm), which includes 600mm door size width). L type					Nos		
1.02	Toilet Cubicle I-Shape (Front Partition) with standard dimension of 12mm thick, 1930mm Height x 1000mm Width which includes 600 mm x 1250mm door size width).					Nos		
	All aspects specified by the manufactures, Greenlam Sturdo Arcs.					Nos		
	* Raw silk finish is available on special demand.							

ALP

Bill of Quantities:Toilet Block Work

S. No.	ITEM DESCRIPTION	APPROVED MAKE	BASIC PRICE	REMARKS FLOOR	QUANTITY TOTAL	UNIT	RATE	AMOUNT
1.00	Partitions & Associated Works							
1.00	Toilet Cubicle							
	<p>Supplying & fixing in position GREENLAM STURDO,ALP Toilet Cubicle (of following standard dimension which includes 600mm door size width) made of heat, bacteria, water, chemical, scratch and impact resistant 12mm thick solid compact laminate panels including doors, pilasters & intermediate panels finished with approved texture/shade as per the detail drawings & as per IS 2046 (Indian Standard). The compact lam should have Green Guard Certificate.It should be anti bactrial (certified by Shri Ram Test House)</p> <p>This also includes providing and fixing in position necessary hardware made out of Alluminium (Grade-6063- T6) & SS 304 GRADE With Alluminium Supporting systems (1) Door Knob, (2) Gravity hinges, (3) Latchlock indicators, (4)Top rail , (5) Coat Hooks, (6) U-Channels, (7) Door stopper channel (8) SS Adjustable foot (9)Noise Deafening Tape etc, (10) Screws (stainless steel in 304 Grade with satin finish) & wall Plugs.</p> <p>The adjustable foot support the pilaster and its based is anchored to the floor with stainless stell & nylon plug fixed in to ground, there U channel are used to attached the divider pannels to the wall. the alluminium toprail coated in natural anodised color to used to fix the pilaster at the top.</p>	ALP model of Greenlam Sturdo						
1.01	Toilet Cubicle with standard dimension Front 12mm thick with 2145mm Height x 1000mm Width (Door Size 600mmx1830mm) ,Partition 12mm thick 1550mm Depth x 1980mm height (Including gap of 150mm), which includes 600mm door size width L type.					Nos		
1.02	Toilet Cubicle I-Shape (Front Partition) with standard dimension of 12mm thick ,2145mm Height x 1000mm Width which includes 600 mm x 1830mm door size width).					Nos		
	All aspects specified by the manufactures, Greenlam Sturdo ALP.					Nos		
	* Raw silk finish is available on special demand.							

CLASSIQUE FLOATER

Bill of Quantities:Toilet Block Work

S. No.	ITEM DESCRIPTION	APPROVED MAKE	BASIC PRICE	REMARKS FLOOR	QUANTITY TOTAL	UNIT	RATE	AMOUNT
1.00	Partitions & Associated Works							
1.00	Toilet Cubicle							
	<p>Supplying & fixing in position GREENLAM STURDO,Classique Floater Toilet Cubicle (of following standard dimension which includes 600mm door size width) made of heat, bacteria, water, chemical, scratch and impact resistant 12mm thick solid compact laminate panels including doors, pilasters & intermediate panels finished with approved texture/shade as per the detail drawings & as per IS 2046 (Indian Standard), The compact lam should have Green Guard Certificate.It should be anti bactrial (certified by Shri Ram Test House)</p> <p>This also includes providing and fixing in position necessary hardware made out of Alluminium (Grade-6063- T6) & SS 304 GRADE With Alluminium Supporting systems (1) Door Knob, (2) Gravity hinges, (3) Latchlock indicators, (4)Top rail , (5) Coat Hooks, (6) U-Channels, (7) Door stopper channel (8) SS Adjustable foot (9)Noise Deafening Tape etc, (9) Screws (stainless steel in 304 Grade with satin finish) & wall Plugs.</p> <p>The top Supporting system will run on the concrete wall to Strengthen &support the systems,it will be sattled on end wall with MS 'L' angles Mid & End pilasters will be fixed with the top support..</p>	Classique Floater model of Greenlam Sturdo						
1.01	Toilet Cubicle with standard dimension Front 12mm thick with 2015 Height x 1000mm Width (Door Size 600mmx1760mm) , Partition 12mm thick 1550mm Depth x 1930mm height (Including gap of 150mm), which includes 600mm door size width). L type					Nos		
1.02	Toilet Cubicle I-Shape (Front Partition) with standard dimension of 12mm thick, 2015mm Height x 1000mm Width which includes 600 mm x 1760mm door size width).					Nos		
	All aspects specified by the manufactures, Greenlam Sturdo Classique Floater Series.					Nos		
	* Raw silk finish is available on special demand.							

CLASSIQUE'S WINGS

Bill of Quantities:Toilet Block Work

S. No.	APPROVED MAKE	BASIC PRICE	REMARKS FLOOR	QUANTITY TOTAL	UNIT	RATE	AMOUNT
1.00							
1.00							
			Classique-Wings model of Greenlam Sturdo				
			<p>Supplying & fixing in position Greenlam Sturdo Classique Wings Toilet Cubicle (of following standard dimension which includes 600mm door size width) made of heat, bacteria, water, chemical, scratch, impact and anti bacterial resistant 12mm & 8mm thick solid compact laminate panels tested by Shriram Test House. Finish of the compact laminate should be Suede / *Raw Silk, which includes doors, pilasters & intermediate panels finished with approved texture/shade as per the detail drawings & as per IS 2046 (Indian Standard) and as per fire retardant BS-476/97 standard. The product should have Green Guard Certificate.</p> <p>This also includes providing and fixing in position necessary hardware made out of Stainless steel (Grade 304) & With MS Supporting systems (1) SS Door Knob, (2) SS Gravity hinges, (3) SS Thumbturn lock indicator, (4) MS Top Support, (5) SS- Coat Hook, (6) SS U-Channels, (7) SS shoe box (8) Shoe box side cover, (9) Noise Deafening Tape etc, (10) Screws & wall Plugs.</p> <p>The top supporting system will run above the ceiling to Strengthen & support the systems,it will be settled on end wall with MS 'L' angles Mid & End pilasters will be fixed with the top support..</p> <p>All other hardware & screws will of stainless steel in 304 Grade with satin finish.</p>				
1.01			Toilet Cubicle with standard dimension Front 18mm thick with 2400 Height x 1000mm Width (Door Size 600mmx1830mm), Partition 12mm thick 1550mm Depth x 1930mm height (Including gap of 100mm).		Nos		
1.02			Toilet Cubicle I-Shape (Front Partition) with standard dimension of 18mm thick, 2400mm Height x 1000mm Width which includes 600 mm x 1830mm door size width).		Nos		
			All aspects specified by the manufactures, Greenlam Sturdo Classique Wings Model or equivalent.				
			*Raw silk finish is available on special demand.				
			** This model is specially recommended for endosed type units for better performance.				

CLASSIQUE'S EVERGREEN

Bill of Quantities:Toilet Block Work

S. No.	ITEM DESCRIPTION	APPROVED MAKE	BASIC PRICE	REMARKS FLOOR	QUANTITY TOTAL	UNIT	RATE	AMOUNT
1.00								
1.00								
				Classique-Evergreen model of Greenlam Sturdo				
			<p>"Providing & fixing Greenlam Sturdo Classique Evergreen Toilet Cubicle (of following standard dimension which includes 600mm door size width) made of heat, bacteria, water, chemical, scratch, impact and anti bacterial resistant 12mm thick solid compact laminate panels tested by Shriram Test House. Finish of the compact laminate should be Suede / *Raw silk, which includes doors, pilasters & intermediate panels finished with approved texture/shade as per the detail drawings & as per IS 2046 (Indian Standard) and as per fire retardant BS-476/97 standard. The product should have Green Guard Certificate.</p> <p>This also includes providing and fixing in position necessary hardware made out of Stainless steel (Grade 304) as per manufacturer's specifications & Architects instructions like (1) Door Knob, (2) Gravity Hinges, (3) Thumb turn lockset with Occupancy indicators, (4) Coat hooks with Door stopper (5) U-Channels, (6) Adjustable foot/pedestal, (7) Top rail with Corner connector (8) Rubber noise deafening tape, (9) Screws & wall Plugs.</p> <p>The top fitting should consist of SS round top rail which will get fixed with pilasters, with SS panel tube holder, SS corner bend (connected with top rail) will be used on the corner of cubicle in absence of brick wall, SS wall fixing is used only on the wall which will hold the ss top rail.</p> <p>All screws will of 304 Grade in stainless steel with satin finish. All pilasters are supported by stainless steel Bottom Cladding. The base of the stainless steel bottom cladding will be anchored to the floor with a clearance height upto 150mm. "</p>					
1.01			Toilet Cubicle with standard dimension of 2025mm Height x 1000mm Width x 1550mm Depth, which includes 600mm door size width).			Nos		
1.02			Toilet Cubicle I-Shape (Front Partition) with standard dimension of 2025mm Height x 1000mm Width which includes 600mm door size width).			Nos		
			All aspects specified by the manufactures, Greenlam Sturdo Classique Evergreen Model or equivalent.					
			*Raw silk finish is available on special demand.					

CLASSIQUE'S INVINCIBLE

Bill of Quantities: Toilet Block Work

S. No.	ITEM DESCRIPTION	APPROVED MAKE	BASIC PRICE	REMARKS FLOOR	QUANTITY TOTAL	UNIT	RATE	AMOUNT
1.00	Partitions & Associated Works							
1.00	Toilet Cubicle							
	<p>Providing & fixing Greenlam Sturdo Classique Invincible Toilet Cubicle (of following standard dimension which includes 600mm door size width) made of heat, bacteria, water, chemical, scratch, impact and anti bacterial resistant 12mm thick solid compact laminate panels tested by Shriram Test House. Finish of the compact laminate should be Suede / *Raw Silk, which includes doors, pilasters & intermediate panels finished with approved texture/shade as per the detail drawings & as per IS 2046 (Indian Standard) and as per fire retardant BS-476/97 standard. The product should have Green Guard Certificate.</p> <p>This also includes providing and fixing in position necessary hardware made out of Stainless steel (Grade 304) as per manufacturer's specifications & Architects instructions like (1) Door Knob, (2) Gravity Hinges, (3) Thumb turn lockset indicators, (4) Coat hooks, (5) U-Channels, (6) SS-Shoe Box Plate (7) MS-Base Plate, (8) Top rail with Corner connector (9) Rubber noise deafening tape (10) Screws & wall Plugs.</p> <p>The top fitting should consist of SS round top rail which will get fixed with pilasters, with SS panel tube holder, SS corner bend (connected with top rail) will be used on the corner of cubicle in absence of brick wall, SS wall fixing is used only on the wall which will hold the ss top rail.</p> <p>All screws will of 304 Grade in stainless steel with satin finish. All pilasters are supported by stainless steel Bottom Cladding. The base of the stainless steel bottom cladding will be anchored to the floor with a clearance height upto 110mm.</p>	Classique-Invincible model of Greenlam Sturdo						
1.01	Toilet Cubicle with standard dimension of 1885mm Height x 1000mm Width x 1550mm Depth, which includes 600mm door size width).					Nos		
1.02	Toilet Cubicle I-Shape (Front Partition) with standard dimension of 1885mm Height x 1000mm Width which includes 600mm door size width).					Nos		
	All aspects specified by the manufactures, Greenlam Sturdo Classique Invincible Model or equivalent.							
	* Raw silk finish is available on special demand.							

CLASSIQUE'S GRANDEUR

Bill of Quantities: Toilet Block Work

S. No.	ITEM DESCRIPTION	APPROVED MAKE	BASIC PRICE	REMARKS FLOOR	QUANTITY TOTAL	UNIT	RATE	AMOUNT
1.00	Partitions & Associated Works							
1.00	Toilet Cubicle							
	<p>Providing & fixing Greenlam Sturdo Classique Grandeur Toilet Cubicle (of following standard dimension which includes 600mm door size width) made of heat, bacteria, water, chemical, scratch, impact anti bacterial resistant 18mm thick solid compact laminate panels tested by Shriram Test House. Finish of the compact laminate should be Suede / *Raw Silk, which includes doors, pilasters & intermediate panels finished with approved texture/shade as per the detail drawings & as per IS 2046 (Indian Standard) and as per fire retardant BS-476/97 standard. The product should have Green Guard Certificate.</p> <p>This also includes providing and fixing in position necessary hardware made out of Stainless steel (Grade 304) as per manufacturer's specifications & Architects instructions like (1) Door Knob, (2) Gravity Hinges, (3) Thumb turn lockset indicators, (4) Coat hooks, (5) U-Channels, (6) SS-Shoe Box Plate (7) MS-Base Plate, (8) Rubber noise deafening tape (9) Screws & Wall Plugs.</p> <p>All screws will of 304 Grade in stainless steel with satin finish, All pilasters are supported by MS-Base steel Bottom Cladding with Stainless Steel Shoe Box Plate. The base of the stainless steel shoe box will be anchored to the floor with a clearance height upto 110mm. Fixing of intermediate panels to the wall shall be stainless steel 'L' – Bracket or stainless U-Channel section are fixed into wall with screw inserts.</p>	Classique-Grandeur model of Greenlam Sturdo						
1.01	Toilet Cubicle with standard dimension of 1840mm Height x 1000mm Width x 1550mm Depth, which includes 600mm door size width).					Nos		
1.02	Toilet Cubicle I-Shape (Front Partition) with standard dimension of 1840mm Height x 1000mm Width which includes 600mm door size width).					Nos		
	All aspects specified by the manufactures, Greenlam Sturdo Classique Grandeur Model or equivalent.							
	* Raw silk finish is available on special demand.							

CLASSIQUE'S VERSATILE

Bill of Quantities:Toilet Block Work

S. No.	ITEM DESCRIPTION	APPROVED MAKE	BASIC PRICE	REMARKS FLOOR	QUANTITY TOTAL	UNIT	RATE	AMOUNT
1.00	Partitions & Associated Works							
1.00	Toilet Cubicle							
	<p>Providing & fixing Greenlam Sturdo Classique Versatile Toilet Cubicle (of following standard dimension which includes 600mm door size width) made of heat, bacteria, water, chemical, scratch, impact and anti bacterial resistant 12mm thick solid compact laminate panels tested by Shriram Test House. Finish of the compact laminate should be Suede / *Raw Silk, which includes doors, pilasters & intermediate panels finished with approved texture/shade as per the detail drawings & as per IS 2046 (Indian Standard) and as per fire retardant BS-476/97 standard. The product should have Green Guard Certificate.</p> <p>This also includes providing and fixing in position necessary hardware made out of Stainless steel (Grade 304) & Aluminium powder coated top rail as per manufacturer's specifications & Architects instructions like (1) SS Door Knob, (2) SS Gravity hinges, (3) SS Thumb turn lockset indicators, (4) Aluminium Powder Coated Top Rail, (5) SS Coat Hooks, (6) SS U-Channels, (7) SS Adjustable Foot, (8) Noise Deafening Tape etc. (9) Screws & wall Plugs.</p> <p>The top fitting should consist of Aluminium Powder Coated top rail which will get fixed with Mid & End pilasters.</p> <p>All other hardware & screws will of stainless steel in 304 Grade with satin finish, Top rail is extruded Aluminium will be powder coated or anodized (Grade 6063 Micron Aluminium). All pilasters are supported by stainless steel adjustable footing with non corrosive steel inserts.</p>	Classique-Versatile model of Greenlam Sturdo						
1.01	Toilet Cubicle with standard dimension of 1955mm Height x 1000mm Width x 1550mm Depth, which includes 600mm door size width).					Nos		
1.02	Toilet Cubicle I-Shape (Front Partition) with standard dimension of 1955mm Height x 1000mm Width which includes 600mm door size width).					Nos		
	All aspects specified by the manufactures, Greenlam Sturdo Classique Versatile Model or equivalent.							
	* Raw silk finish is available on special demand.							

VIBRANCE'S RAGE

Bill of Quantities:Toilet Block Work

S. No.	ITEM DESCRIPTION	APPROVED MAKE	BASIC PRICE	REMARKS FLOOR	QUANTITY TOTAL	UNIT	RATE	AMOUNT
1.00	Partitions & Associated Works							
1.00	Toilet Cubicle							
	<p>Providing & fixing Greenlam Sturdo Vibrance Rage Toilet Cubicle (of following standard dimension which includes 600mm door size width) made of heat, bacteria, water, chemical, scratch, impact and anti bacterial resistant 12mm thick solid compact laminate panels tested by Shriram Test House. Finish of the compact laminate should be Suede / *Raw Silk, which includes doors, pilasters & intermediate panels finished with approved texture/shade as per the detail drawings & as per IS 2046 (Indian Standard) and as per fire retardant BS-476/97 standard. The product should have Green Guard Certificate.</p> <p>This also includes providing and fixing in position necessary hardware made out of aluminium & having Gun Metal finish, as per manufacturer's specifications & Architects instructions like (1) Door Knob, (2) Gravity Hinges, (3) Thumb turn lockset with Occupancy indicator, (4) Coat Hook (5) U-Channel, (6) Adjustable foot/pedestal, (7) Aluminium Powder Coated Top Rail, (8) Rubber noise deafening tape, (9) Screws & wall Plugs.</p> <p>The top fitting should consist of Aluminium Powder Coated top rail which will get fixed with Mid & End pilasters.</p> <p>All screws will of 304 Grade in stainless steel with satin finish. All pilasters are supported by stainless steel Bottom Cladding. The base of the stainless steel bottom cladding will be anchored to the floor with a clearance height upto 150mm.</p>	Vibrance's Rage model of Greenlam Sturdo						
1.01	Toilet Cubicle with standard dimension of 1995mm Height x 1000mm Width x 1550mm Depth, which includes 600mm door size width).					Nos		
1.02	Toilet Cubicle I-Shape (Front Partition) with standard dimension of 1995mm Height x 1000mm Width which includes 600mm door size width).					Nos		
	All aspects specified by the manufactures, Greenlam Sturdo Vibrancee Rage Model or equivalent.							
	* Raw silk finish is available on special demand.							

VIBRANCE'S SERENE

Bill of Quantities: Toilet Block Work

S. No.	ITEM DESCRIPTION	APPROVED MAKE	BASIC PRICE	REMARKS FLOOR	QUANTITY TOTAL	UNIT	RATE	AMOUNT
1.00	Partitions & Associated Works							
1.00	Toilet Cubicle							
	<p>Providing & fixing Greenlam Sturdo Vibrance Serene Toilet Cubicle (of following standard dimension which includes 600mm door size width) made of heat, bacteria, water, chemical, scratch, impact and anti bacterial resistant 12mm thick solid compact laminate panels tested by Shriram Test House. Finish of the compact laminate should be Suede / *Raw Silk, which includes doors, pilasters & intermediate panels finished with approved texture/shade as per the detail drawings & as per IS 2046 (Indian Standard) and as per fire retardant BS-476/97 standard. The product should have Green Guard Certificate.</p> <p>This also includes providing and fixing in position necessary hardware made out of Nylon Polyamide Grade-6 & Aluminium powder coated top rail as per manufacturer's specifications & Architects instructions like (1) Door Knob, (2) Gravity Hinges, (3) Thumb turn lockset indicators, (4) Aluminium Top Rail, (5) Coat Hooks, (6) U-Channels, (7) Adjustable Foot, (8) Noise Deafening Tape (9) Screws & wall plugs etc.</p> <p>The top fitting should consist of Aluminium Powder Coated top rail which will get fixed with Mid & End pilasters.</p> <p>All screws will of 304 Grade in stainless steel with satin finish. Top rail is extruded Aluminium will be powder coated or anodized (Grade 6063 Micron Aluminium). All pilasters are supported by grade- 6 Nylon Polyamide Thermoplastic palm design pedestal footing with non corrosive steel inserts. The base diameter 65mm and neck diameter of 33mm anchored to the floor with grade 304 satin finish stainless steel screws with push fit capping at a clearance height of 150mm. Model is Heat and Bacteria Resistant Polyamide in which aluminium U-Channel will be used for the fixing of intermediate panels to the wall.</p>	Vibrance-Serene model of Greenlam Sturdo						
1.01	Toilet Cubicle with standard dimension of 1995mm Height x 1000mm Width x 1550mm Depth, which includes 600mm door size width).					Nos		
1.02	Toilet Cubicle I-Shape (Front Partition) with standard dimension of 1995mm Height x 1000mm Width which includes 600mm door size width).					Nos		
	All aspects specified by the manufactures, Greenlam Sturdo Vibrance Serene Model or equivalent.							
	* Raw silk finish is available on special demand.							

VIBRANCE'S ELEGANCE

Bill of Quantities: Toilet Block Work

S. No.	ITEM DESCRIPTION	APPROVED MAKE	BASIC PRICE	REMARKS FLOOR	QUANTITY TOTAL	UNIT	RATE	AMOUNT
1.00	Partitions & Associated Works							
1.00	Toilet Cubicle							
	<p>Providing & fixing Greenlam Sturdo Vibrance Elegance Toilet Cubicle (of following standard dimension which includes 600mm door size width) made of heat, bacteria, water, chemical, scratch, impact and anti bacterial resistant 12mm thick solid compact laminate panels tested by Shriram Test House. Finish of the compact laminate should be Suede / *Raw Silk, which includes doors, pilasters & intermediate panels finished with approved texture/shade as per the detail drawings & as per IS 2046 (Indian Standard) and as per fire retardant BS-476/97 standard. The product should have Green Guard Certificate.</p> <p>This also includes providing and fixing in position necessary hardware made out of Nylon Polyamide Grade-6 & Aluminium powder coated top rail as per manufacturer's specifications & Architects instructions like (1) Verticle Post Door Channel (anodized), (2) Hinges Adaptors, (3) Gravity Hinges (4) Privacy Thumbturn c/w Occupancy Indicator, (5) Coat Hook, (6) Door Knob, (7) Noise Deafening Tape (8) Screws & wall Plugs.</p> <p>The Top rail should be extruded Aluminium which should be powder coated or anodized (Grade 6063 Micron Aluminium). Pilaster to be supported and frame with 50mm diameter vertical post with circular vertical poll foot and Intermediate panel is anchored to the wall with powder coating or anodized aluminium U & F Channel. Door panel should be fixed by 80mm diameter vertical post with noise deafening tape. All screws will of 304 Grade in stainless steel with satin finish.</p>	Vibrance's Elegance model of Greenlam Sturdo						
1.01	Toilet Cubicle with standard dimension of 1995mm Height x 1000mm Width x 1550mm Depth, which includes 600mm door size width).					Nos		
1.02	Toilet Cubicle I-Shape (Front Partition) with standard dimension of 1995mm Height x 1000mm Width which includes 600mm door size width).					Nos		
	All aspects specified by the manufactures, Greenlam Sturdo Vibrance Elegance Model or equivalent.							
	* Raw silk finish is available on special demand.							

Annexure

VIBRANCE'S SPLENDID

Bill of Quantities:Toilet Block Work

S. No.	ITEM DESCRIPTION	APPROVED MAKE	BASIC PRICE	REMARKS FLOOR	QUANTITY TOTAL	UNIT	RATE	AMOUNT
1.00	Partitions & Associated Works							
1.00	Toilet Cubicle							
	<p>Providing & fixing Greenlam Sturdo Vibrance Splendid Toilet Cubicle (of following standard dimension which includes 600mm door size width) made of heat, bacteria, water, chemical, scratch, impact and anti bacterial resistant 12mm thick solid compact laminate panels tested by Shriram Test House. Finish of the compact laminate should be Suede / *Raw Silk, which includes doors, pilasters & intermediate panels finished with approved texture/shade as per the detail drawings & as per IS 2046 (Indian Standard) and as per fire retardant BS-476/97 standard. The product should have Green Guard Certificate.</p> <p>This also includes providing and fixing in position necessary hardware made out of Nylon Polyamide Grade-6 & Aluminium powder coated top rail as per manufacturer's specifications & Architects instructions like (1) D Post Door Channel (anodized), (2) Hinges Adaptors, (3) Gravity Hinges (4) Privacy Thumbturn c/w Occupancy Indicator, (5) Coat Hook, (6) Door Knob, (7) Noise Deafening Tape (8) Screws & wall Plugs.</p> <p>All the hardware shall be made of polyamide-6 material. Aluminium D-Post channel of 40mm dia which should be fixed to the wall with SS-304 screws, Door is gripped with the poles by an arrangement of hinge adaptor & hinges. Aluminium poles are incorporated with the rubber strip to reduce the noise effect.</p>	Vibrance-Splendid model of Greenlam Sturdo						
1.01	Toilet Cubicle with standard dimension of 1980mm Height x 600mm to 900mm Width.					Nos		
	All aspects specified by the manufactures, Greenlam Sturdo Vibrance Splendid model or equivalent.							
	* Raw silk finish is available on special demand.							

Annexure

LOCKERS

Bill of Quantities:Toilet Block Work

S. No.	ITEM DESCRIPTION	APPROVED MAKE	BASIC PRICE	REMARKS FLOOR	QUANTITY TOTAL	UNIT	RATE	AMOUNT
1.00	Partitions & Associated Works							
1.00	Toilet Cubicle							
	<p>Supplying & fixing in position GREENLAM LOCKER ,Locker made of heat, bacteria, water, chemical, scratch and impact resistant 03mm & 09mm thick solid compact laminate panels including doors, self, side pannel, Top & Bottom panels finished with approved texture/shade as per the detail drawings & as per IS 2046 (Indian Standard). The compact lam should have Green Guard Certificate.It should be anti bactrial (certified by Shri Ram Test House)</p> <p>This also includes providing and fixing in position necessary hardware made out of Alluminium (Grade-6063- T6) & Stailless steel (grade- 304) (1) Cam lock (2) Hinges, (3) Front section (4) Back section , (5) Infill section (6) Rubber lining (9) Screws & Nut bolt</p> <p>Locker shall be constructed with 4 alluminium interlocking supporting frame work, making it strong and rigid.</p>	Locker model of Greenlam Sturdo						
1.01	Standard dimension of locker unit shall be: Width 300mm x Depth 450mm x Height 1800mm Locker 1 Tier - Locker 5 Tier - Locker 2 Tier - Locker 6 Tier - Locker 3 Tier - Locker Z Shaped - Locker 4 Tier					Nos		
	All aspects specified by the manufactures, Greenlam Sturdo Locker Series					Nos		