

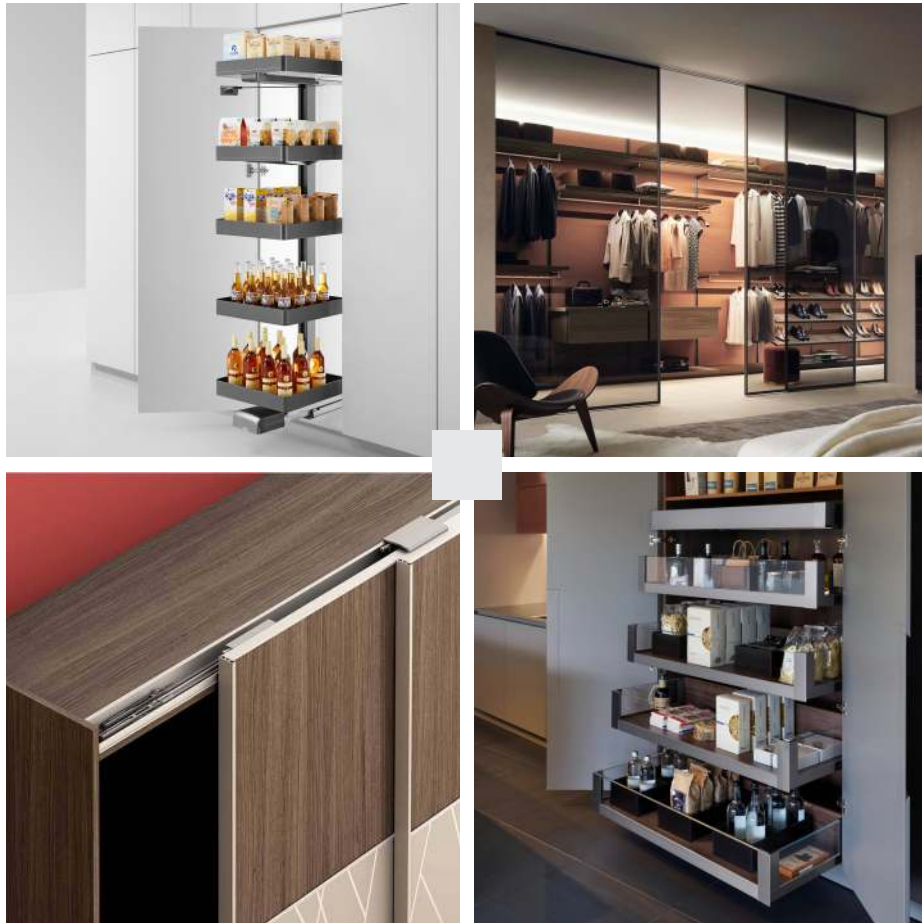

PRICE LIST

W. E. F. 25/08/2022

I N S P I R I N G - E X P R E S S I V E - F U N C T I O N A L



CONTENTS

MORTISE HANDLES

Page 04

LOCK BODY & CYLINDER

Page 07

PULL HANDLES

Page 08

CABINET HANDLES

Page 12

KIDS HANDLES & KNOBS

Page 15

CONCEALED HANDLES

Page 16

SLIDING SYSTEMS / PROFILES

Page 18

PROFILES ACCESSORIES

Page 29

DECORATIVE U, L & T CHANNEL

Page 30

FURNITURE LIGHTING

Page 30

WARDROBE ACCESSORIES

Page 32

HIGH END KITCHEN STORAGE

Page 33

DRAWERS

Page 35

NON-SLIP DRAWER MAT

Page 36

SLIDING FITTINGS

Page 36

BATHROOM ACCESSORIES

Page 40

CLOTH HOOKS

Page 41

SS PIPES

Page 42

HINGES

Page 42

DRAWER SLIDES

Page 44

WARDROBE & DRAWER LOCKS

Page 45

FURNITURE FITTINGS

Page 45



SMH-12

Material : SS 304

Finish	MRP
Satin+CP	2300
Black M.+Rose Gold	2300
CRG Matt+Black	2300

Rate Per Pair



Satin+CP



Black M.+Rose Gold



CRG Matt+Black



SMH-13

Material : Zinc

Finish	MRP
SS Matt+CP	2840
RG-PVD+Grey	3700
Grey+Gold-PVD	3700

Rate Per Pair



SS Matt+CP



RG-PVD+Grey



Grey+Gold-PVD



SMH-14

Material : Zinc

Finish	MRP
CP+SS Matt	2840
RG-PVD+Grey	3700
Grey+Gold-PVD	3700

Rate Per Pair



CP+SS Matt



RG-PVD+Grey



Grey+Gold-PVD



SMH-15

Material : Zinc

Finish	MRP
CP+SS Matt	3140
Matt Antique + Grey	3140
PVD-RG + Grey Matt	3840
PVD- Grey + Grey Matt	3840

Rate Per Pair



CP+SS Matt



Matt Antique+Grey



PVD-RG+Grey Matt



PVD-Grey+Grey Matt



SS+Grey



Black+Gold-PVD



Grey+Rose Gold-PVD

SMH-16

Material : Zinc

Finish	MRP
SS+Grey	3140
Black+Gold-PVD	3140
Grey+Rose Gold-PVD	3140

Rate Per Pair



SS+CP



Antique+Grey



Rose Gold PVD+Wood



Black+Black PVD

SMH-17

Material : Zinc

Finish	MRP
SS+CP	3040
Antique+Grey	3040
Rose Gold PVD+Wood	4040
Black+Black PVD	3640

Rate Per Pair



SS+CP



Antique+Gold PVD



Black+Black PVD



Rose Gold PVD+Black

SMH-18

Material : Zinc

Finish	MRP
SS+CP	3625
Antique+Gold PVD	3625
Black+Black PVD	3625
Rose Gold PVD+Black	4025

Rate Per Pair



SS+Grey



Black+Gold PVD



Grey+Rose Gold PVD

SMH-16

(10" Plate)

Material : Zinc

Finish	MRP
SS+Grey	3140
Black+Gold PVD	3140
Grey+Rose Gold PVD	3140

Rate Per Pair



SS+CP



Black+Black PVD



Antique+Grey

SMH-17 (10" Plate)

Material : Zinc

Finish

SS+CP
Black+Black PVD
Antique+Grey

MRP

3040
3640
3040

Rate Per Pair



SS+CP



Black+Black PVD



Antique+GoldPVD

SMH-18 (10" Plate)

Material : Zinc

Finish

SS+CP
Black+Black PVD
Antique+Gold PVD

MRP

3625
3625
3625

Rate Per Pair

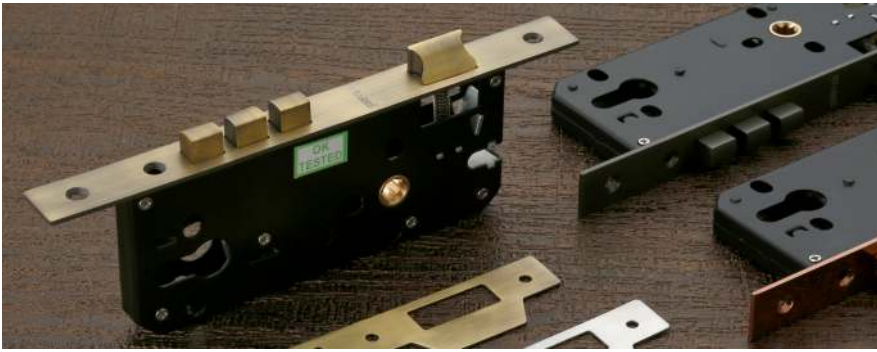

SLB-10"

45mm Backset
85mm Centre Distance

Material : Brass

Finish MRP

SS	975
Antique	1075
Rose Gold	1075
Grey	1075
Black	1075

Rate Per Pc.



SLB-20"

45mm Backset
85mm Centre Distance

Material : Brass

Finish MRP

SS	900
----	-----

Rate Per Pc.

SILENT LOCK BODY



SLB-30"

60mm Backset
85mm Centre Distance

Finish MRP

SS	1125
Antique	1225
Rose Gold	1225
Grey	1225
Black	1225

Rate Per Pc.



Brass Cylinder

Material : Brass

Rate Per Pc.

Both Side Key (BSK)

Finish	MRP 60mm	MRP 70mm	MRP 80mm
SS	1050	1150	1250
Antique	1150	1250	1350
Rose Gold	1150	1250	1350
Grey	1150	1250	1350
Black	1150	1250	1350

1 Side Knob+ 1 Side Key (OSK)

MRP 60mm	MRP 70mm	MRP 80mm
1150	1250	1350
1250	1350	1450
1250	1350	1450
1250	1350	1450
1250	1350	1450

1 Side Coin + 1 Side Knob

MRP 60mm	MRP 70mm	MRP 80mm
1050	1150	1250
1150	1250	1350
1150	1250	1350
1150	1250	1350
1150	1250	1350

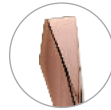

Rose Gold



Gold

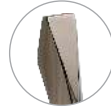

Black

ST-1401

Material : Zinc

Size	MRP
C/C 200	4150
C/C 300	5750
C/C 450	8350

Rate Per Pair



Rose Gold



Gold



Black

ST-1402

Material : Zinc

Size	MRP
C/C 200	5050
C/C 300	7550

Rate Per Pair



CRG Matt+Black



Black Matt+RG



Satin+CP

ST-1403

Material : SS 304

Size (mm)	MRP
C/C 200 (22mm Dia)	3150
C/C 300 (22mm Dia)	4050
C/C 450 (25mm Dia)	6250

Rate Per Pair



CRG Matt+Black

ST-1404

Material : SS 304

Size	MRP
C/C 300	3750
C/C 450	4850
C/C 600	6050

Rate Per Pair

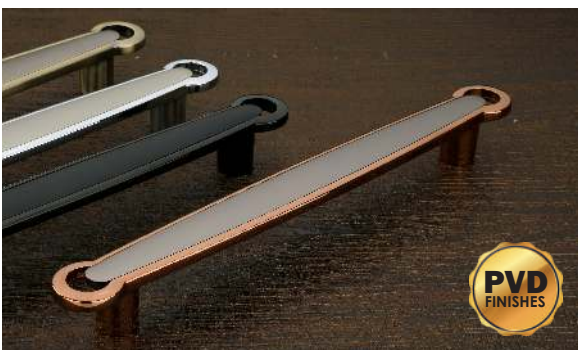

SS+CP



Black+
Black-PVD



Matt Antique+
Antique



Grey+
Rose Gold-PVD

ST-1405

Material : Zinc

Size	C/C 300	C/C 450
SS+CP	6950	9850
Matt Atq.+Atq.	6950	9850
Blk+Blk-PVD	7850	11350
Grey+RG-PVD	7850	11350

Rate Per Pair



SS+Grey



Grey+
Rose Gold-PVD



Black+
Gold-PVD

ST-1406

Material : Zinc

Size (mm) MRP
C/C 300 6650
C/C 450 8750

Rate Per Pair



Rose Gold+
Black



Antique+Gold



Gold+Black

ST-1501

Material : Zinc

Size MRP
C/C 300 8700
C/C 450 16200

Rate Per Pair



Grey Matt+Gloss



RG Matt+Gloss



Antique



Gold Matt+Gloss

ST-1502

Material : Zinc

Size MRP
C/C 300 9450
C/C 450 17550

Rate Per Pair



Antique
+Grey



Grey+
Rose Gold PVD



Matt Rose Gold
+Black PVD

ST-1407

Material : Zinc

Size	C/C 300	C/C 450
Atq.+Grey	6850	9650
Grey+RG PVD	7350	10650
Matt RG+Blk-PVD	7350	10650

Rate Per Pair



ST-1304

Material : Zinc
Finish : Matt Ant. Brushed

Size (mm)	MRP
C/C 310 E/E 471	7000 Per Pc.



ST-1306

Material : Zinc
Finish : Matt Ant. Brushed

Size (mm)	MRP
C/C 500 E/E 560	12000 Per Pc.



ST-1204

Material : Zinc
Finish : SS, Antique

Size (mm)	MRP
C/C 200	3950
C/C 300	5450 Per Pair



ST-1012

Material : Aluminum
Finish : Chrome+White Lip Seashell

Size (mm)	MRP
C/C 300 E/E 450	11000
C/C 450 E/E 600	15500 Per Pair



ST-1013

Material : Aluminum
Finish : Chrome+Black Lip Seashell

Size (mm)	MRP
C/C 300 E/E 450	11000 Per Pair



ST-1102

Material : SS 304
Finish : S/S + Mirror Finish

Size (mm)	MRP
C/C 550 E/E 600	18500
C/C 850 E/E 900	23000
C/C 1150 E/E 1200	30000 Per Pair



ST-1101

Material : SS 304
Finish : Ant. Bronze+Green Seashell

Size (mm)	MRP
C/C 800 E/E 1000	73500 Per Pair



ST-1203

Material : Zinc
Finish : Chrome

Size (mm)	MRP
C/C 300	3200
C/C 450	5000 Per Pair



ST-909

Material : Aluminum
Finish : Brushed Satin Nickel

Size (mm)	MRP
C/C 350 E/E 400	4150 Per Pair



ST-910

Material : Aluminum
Finish : Brushed Satin Nickel

Size (mm)	MRP
C/C 300 E/E 350	3000
C/C 350 E/E 400	4150 Per Pair



STML-005

Material : Zinc
Finish : Satin Nickel

MRP : 9500 Per Set



Rose Gold



Antique



SS Matt

EM-101

Material : Zinc

Size (mm)	MRP
C/C 96	280
C/C 160	425
C/C 224	610
C/C 288	730
C/C 448	1150

Rate Per Pc.



SS+CP



Grey+Rose Gold

EM-102

Material : Zinc

Size (mm)	MRP
C/C 96	435
C/C 160	610
C/C 224	805
C/C 288	995

Rate Per Pc.



Black



Satin

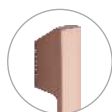

Rose Gold

EM-201

Material : Aluminum

Size (mm)	MRP
E/E 200	605
E/E 500	1395
E/E 700	1875
E/E 900	2375
E/E 1200	3075

Rate Per Pc.



Chrome



RG PVD

EM-202

Material : Zinc

Size (mm)	Chrome	RG PVD
C/C 96	210	380
C/C 160	300	560
C/C 256	485	905
C/C 320	625	1150

Rate Per Pc.





EM-203

Material : Zinc

Size (mm)	SS/Chrome	PVD
C/C 96	295	530
C/C 160	450	790
C/C 256	710	1230
C/C 320	910	1540

Rate Per Pc.



Chrome



SS Matt



Gold PVD



Grey PVD

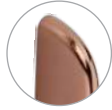

RG PVD



EM-204

Material : Aluminum

Size (mm)	MRP
E/E 200	760
E/E 320	1150
E/E 500	1840
E/E 700	2690
E/E 900	3350
E/E 1200	4450

Rate Per Pc.



Black + RG



Satin + Black



R/G + Black



EM-205

Material : Zinc

Size (mm)	SS+CP	Antique+Grey & PVD
C/C 96	380	560
C/C 160	550	850
C/C 256	790	1300
C/C 320	970	1640

Rate Per Pc.



SS+CP



Antique+Grey



PVD Black+Black



Rose Gold PVD +Wood



EM-206

Material : Zinc

Size (mm)	SS+CP	Antique+Grey & PVD
C/C 128	440	600
C/C 192	610	770
C/C 256	810	1060
C/C 320	1020	1250

Rate Per Pc.



SS+CP



Antique+Grey



Black+Black PVD



Grey+Rose Gold PVD



EM-207 (Left & Right)

Material : Aluminium+Zinc

Size (mm) Black+Black PVD

E/E 200	1130
E/E 500	2260
E/E 900	3760

Rate Per Pc.



EM-465

Material : Zinc

Finish : Chrome, Brushed S. Nickel

Size (mm)	MRP
C/C 96	165
C/C 160	270
C/C 224	375
C/C 288	500



EM-435

Material : Aluminum

Finish : Chrome

Size (mm)	MRP
C/C 128	430
C/C 192	590
C/C 256	750
C/C 320	930
C/C 480	1200
C/C 564	1570



SR-725

Material : Aluminum

Finish : Chrome

Size (mm)	MRP
C/C 224	700
C/C 352	950
C/C 448	1275
C/C 640	1625



SR-595

Material : Zinc
Finish : Chrome+Sea Shell

Size (mm)	MRP
C/C 96	650
C/C 128	785
C/C 192	1040
C/C 256	1250
C/C 320	1775



EM-402

Material : Zinc
Finish : Black Brushed With Crystal

Size (mm)	MRP
C/C 96	430
C/C 160	560
C/C 224	765
C/C 320	1025



EM-430

Material : Zinc
Finish : Grey Nickel

Size (mm)	MRP
C/C 96	250
C/C 160	375
C/C 224	550
C/C 320	875

KIDS HANDLES & KNOBS

Material : Rubber



H-11

Size (mm)	MRP
128	275



H-12

Size (mm)	MRP
96	200
128	275



K-50

MRP
110



K-51

MRP
110



K-52

MRP
110



K-64

MRP
200



K-65

MRP
200



Satin



Chrome



CRG Gloss

EM-360

Material : Zinc

Finish	MRP
Satin	320
Chrome	320
CRG Gloss	370

Rate Per Pc.

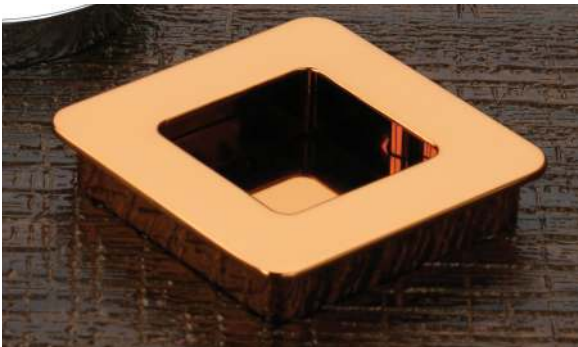

Satin



Chrome



CRG Gloss

EM-362

Material : Zinc

Finish	MRP
Satin	320
Chrome	320
CRG Gloss	370

Rate Per Pc.



SS Brushed



Rose Gold Brushed

EM-350

Material : Aluminum + Zinc

Size (mm)	MRP
C/C 96	390
C/C 160	520
C/C 224	650
C/C 320	800

Rate Per Pc.



Black

EM-355

Material : Aluminium + SS

Size (mm)	MRP
C/C 160	510
C/C 320	910

Rate Per Pc.



Black

EM-365

Material : Aluminium + SS

Size (mm)	MRP
C/C 160	510
C/C 320	910

Rate Per Pc.



SS Matt



Grey Matt



Black+
Rose Gold PVD



EM-370

Material : Zinc

Size (mm)	SS Matt	Grey Matt	Blk+RG PVD
C/C 96	380		450
C/C 160	590		770
C/C 224	850		1030
C/C 288	1000		1210

Rate Per Pc.

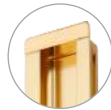

Gold



Black

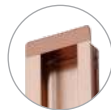

Rose Gold



SS+CP

EM-380

Material : Aluminum + Zinc

Size (mm)	MRP	Gold
C/C 96	225	295
C/C 160	310	370
C/C 224	380	450
C/C 320	490	570
C/C 448	630	720
C/C 700	950	1050



Rate Per Pc.



SS+CP



Antique+Antique



Grey+RG
PVD



Black+Black
PVD



EM-390

Material : Zinc

Size (mm)	SS+CP MRP	Atq+Atq MRP	PVD MRP
C/C 96	430	530	630
C/C 160	620	780	950
C/C 224	890	1150	1450

Rate Per Pc.



SS+CP



Antique+Antique



Grey+RG PVD



Black+Black PVD



EM-400

Material : Zinc

Size (mm)	SS+CP MRP	Atq+Atq MRP	PVD MRP
C/C 96	430	530	630
C/C 160	620	780	950
C/C 224	890	1150	1450
C/C 288	1090	1390	1710

Rate Per Pc.



EM-306

Material : Aluminum + Zinc
Finish : SS Brushed

Size (mm)	MRP
C/C 96	290
C/C 160	370
C/C 224	480
C/C 320	610
C/C 480	890



EM-310

Material : Aluminum + Zinc
Finish : AL/SL+Chrome

Size (mm)	MRP
C/C 96	310
C/C 160	440
C/C 224	550
C/C 320	680
C/C 480	1050
C/C 600	1470



EM-580

Material : Zinc
Finish : Chrome, BSN

Size (mm)	MRP
64	265
96	315

Side Profile

Product Code : SASP-01
Description : Size : 3 Mtr (With Gasket)
Material : Aluminium

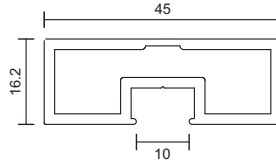

Finish : Matt Black
MRP : 3950
Per Pc.

Top & Bottom Profile

Product Code : SATBP-02
Description : Size : 3 Mtr (With Gasket)
Material : Aluminium

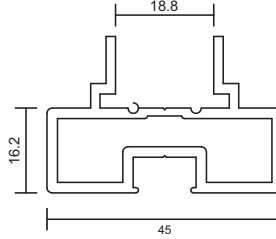

Finish : Matt Black
MRP : 4700
Per Pc.

Divider Profile

Product Code : SADP-03
Description : Size : 3 Mtr
Material : Aluminium

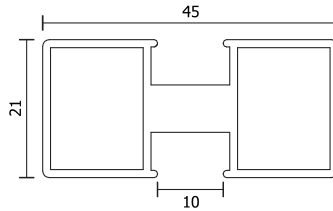

Finish : Matt Black
MRP : 3025
Per Pc.

Divider Profile

Product Code : SADP-04
Description : Size : 3 Mtr
Material : Aluminium

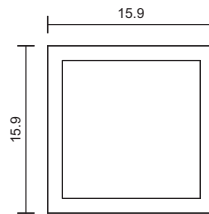

Finish : Matt Black
MRP : 1175
Per Pc.

Connector (With screws)

Product Code : SAPC-07
Material : Zinc



MRP : 1950
1 Set
(4 Pcs.)

Divider Profile Connector (With screws)

Product Code : SADPC-08
Material : Aluminium



MRP : 95
1 Set
(2 Pcs.)

Handle

Product Code : SAH-05
Material : Aluminium



MRP : 1060
Per Pc.

Handle + Lock

Product Code : SAHL-06
Material : Aluminium



MRP : 2125
Per Pc.

Fixed Door Fitting

Product Code : SFDF-10
Material : SS



MRP : 1175
Per Set

Sliding Channel

Product Code : SSC-14
Finish : Matt Black

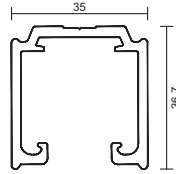

Size	MRP
3 Mtr	4500
3.97 Mtr	5850
	Per Pc.

Track Cover

Product Code : SSTC-14
Finish : Matt Black

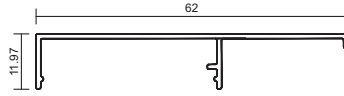

Size	MRP
3 Mtr	1500
3.97 Mtr	1950
	Per Pc.

Heavy Sliding Channel

Product Code : SSC-12
Finish : Matt Black

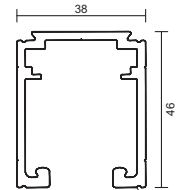

Size	MRP
3 Mtr	5500
3.97 Mtr	7150
	Per Pc.

Track Cover

Product Code : SSTC-12
Finish : Matt Black

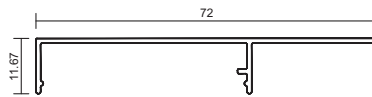

Size	MRP
3 Mtr	1750
3.97 Mtr	2275
	Per Pc.

Sliding Fitting

Product Code : SSR-14
Description : Both Side Soft Close
Weight Cap. : 80 Kg.

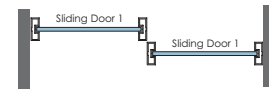

MRP
5850
Per Pair

Heavy Sliding Fitting

Product Code : SSR-15
Description : Both Side Soft Close
Weight Cap. : 120 Kg.

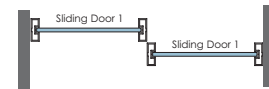
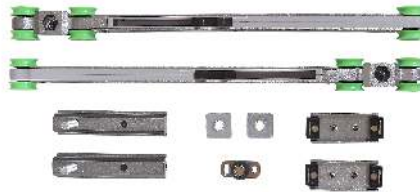

MRP
8050
Per Pair

Telescopic Sliding Roller

Product Code : SSR-114 (1+2)
Product Code : SSR-114 (1+3)
Description : Both Side Soft Close
Weight Cap. : 80 Kg.

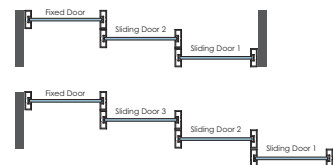

MRP
(1+2) 18250
(1+3) 23250
Per Pair

Telescopic Sliding Roller

Product Code : SSR-115 (1+2)
Product Code : SSR-115 (1+3)
Description : Both Side Soft Close
Weight Cap. : 120 Kg.

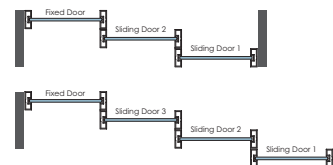

MRP
(1+2) 23250
(1+3) 28250
Per Pair

Synchronize Roller

Product Code : SSR-214
Description : Both Side Soft Close
Weight Cap. : 80 Kg.

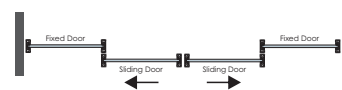

MRP
18250
Per Pair

Synchronize Roller

Product Code : SSR-215
Description : Both Side Soft Close
Weight Cap. : 120 Kg.

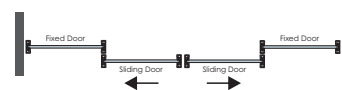

MRP
23250
Per Pair

Side Profile

Product Code : SCSP-01

Description : Size : 3 Mtr (With Gasket)
Material : Aluminium

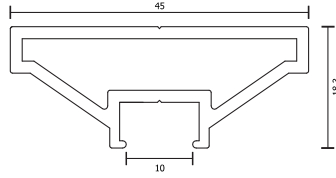

Finish	MRP
Matt Black	3950
	Per Pc.

Top & Bottom Profile

Product Code : SCTBP-02

Description : Size : 3 Mtr (With Gasket)
Material : Aluminium

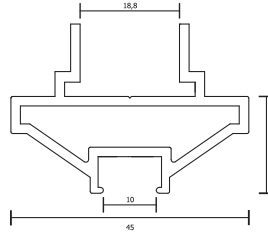

Finish	MRP
Matt Black	4700
	Per Pc.

Connector (With screws)

Product Code : SCPC-03

Material : Zinc



MRP
690
1 Set
(4 Pcs.)

Fixed Door Fitting

Product Code : SFDF-10

Material : SS



MRP
1175
Per Set

Sliding Channel

Product Code : SSC-14
Finish : Matt Black

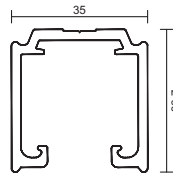

Size	MRP
3 Mtr	4500
3.97 Mtr	5850
	Per Pc.

Track Cover

Product Code : SSTC-14
Finish : Matt Black

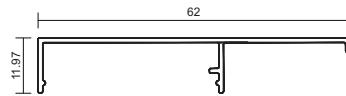

Size	MRP
3 Mtr	1500
3.97 Mtr	1950
	Per Pc.

Heavy Sliding Channel

Product Code : SSC-12
Finish : Matt Black

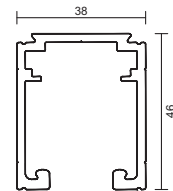

Size	MRP
3 Mtr	5500
3.97 Mtr	7150
	Per Pc.

Track Cover

Product Code : SSTC-12
Finish : Matt Black

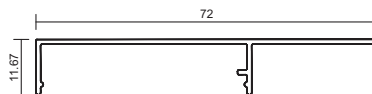

Size	MRP
3 Mtr	1750
3.97 Mtr	2275
	Per Pc.

Sliding Fitting

Product Code : SSR-14
Description : Both Side Soft Close
Weight Cap. : 80 Kg.

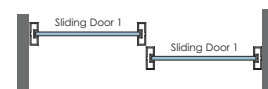

MRP
5850
Per Pair

Heavy Sliding Fitting

Product Code : SSR-15
Description : Both Side Soft Close
Weight Cap. : 120 Kg.

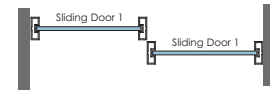
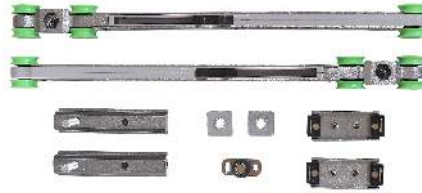

MRP
8050
Per Pair

Telescopic Sliding Roller

Product Code : SSR-114 (1+2)
Product Code : SSR-114 (1+3)
Description : Both Side Soft Close
Weight Cap. : 80 Kg.

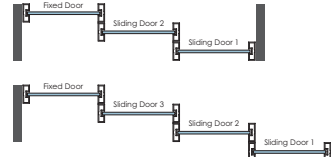

MRP
(1+2) 18250
(1+3) 23250
Per Pair

Telescopic Sliding Roller

Product Code : SSR-115 (1+2)
Product Code : SSR-115 (1+3)
Description : Both Side Soft Close
Weight Cap. : 120 Kg.

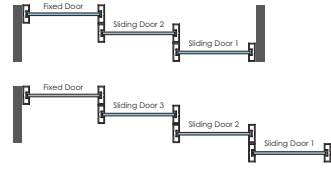

MRP
(1+2) 23250
(1+3) 28250
Per Pair

Synchronize Roller

Product Code : SSR-214
Description : Both Side Soft Close
Weight Cap. : 80 Kg.

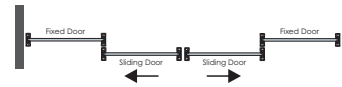

MRP
18250
Per Pair

Synchronize Roller

Product Code : SSR-215
Description : Both Side Soft Close
Weight Cap. : 120 Kg.

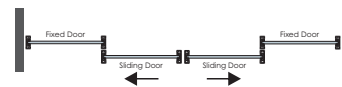

MRP
23250
Per Pair

UNICO / FORTE SLIDING DOOR PROFILE

Unico Handle Profile

Product Code : SUHP-01
Material : Aluminium

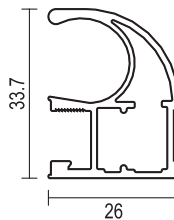

Finish	MRP 2.5 Mtr	MRP 3 Mtr
Matt Black	2950	3540
Champagne	2950	3540
Matt Iron Grey	2950	3540
	Per Pc.	Per Pc.

Forte Handle Profile

Product Code : SFHP-01
Material : Aluminium

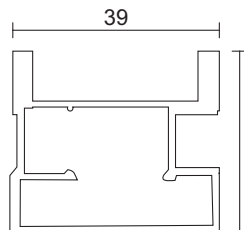

Finish	MRP 2.5 Mtr	MRP 3 Mtr
Matt Black	4350	5220
Champagne	4350	5220
Matt Iron Grey	4350	5220
	Per Pc.	Per Pc.

Bottom Profile

Product Code : SBP-02
Description : 3 Mtr
Material : Aluminium

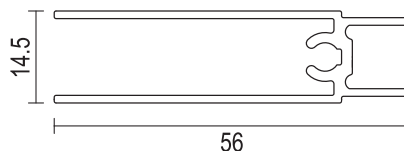

Finish	MRP
Matt Black	3150
Champagne	3150
Matt Iron Grey	3150

Per Pc. 21

Top Profile

Product Code : STP-03

Description : 3 Mtr
Material : Aluminium

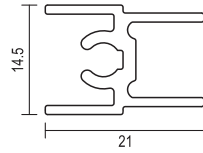

Finish	MRP
Matt Black	1650
Champagne	1650
Matt Iron Grey	1650
	Per Pc.

Divider Profile

Product Code : SDP-04

Description : 3 Mtr
Material : Aluminium

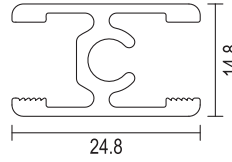

Finish	MRP
Matt Black	2190
Champagne	2190
Matt Iron Grey	2190
	Per Pc.

Gasket

Product Code : SGK-05
Description : Use for 5mm Glass



Size	MRP
15 Mtr	1240
	Per Box

Brush Seal

Product Code : SBS-06
Description : 9mm(W) x 8mm(D)
Finish : Dark Grey



Size	MRP
10 Mtr	495
	Per Box

Forte Sliding Lock

Product Code : SFSL-07



MRP
1125
Per Pc.

Sliding Channel

Product Code : SSC-609

Description : Top & Bottom
Material : Aluminium

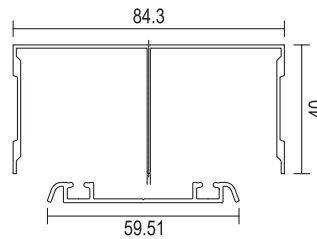

Finish	MRP 2.5 Mtr	MRP 3.97 Mtr
Matt Black	4380	6950
Champagne	4380	6950
Matt Iron Grey	4380	6950
	Per Set	Per Set

Soft Close Sliding Roller

Product Code : SSR-809
Description : Both Side Soft Close
Weight Cap. : 50 kg (one door)



MRP
2775
Per Set (1 Door)

Vertical Profile

Product Code : SCDP-01

Description : 3 Mtr
Material : Aluminium

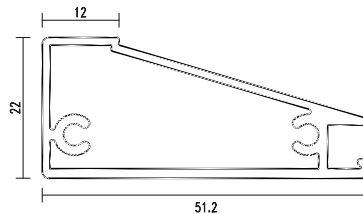

Finish	MRP
Matt Black	3425
Matt Gold Brushed	3425
	Per Pc.

Top & Bottom Profile

Product Code : SCDP-02

Finish : Matt Black, Matt Gold Brushed
Material : Aluminium

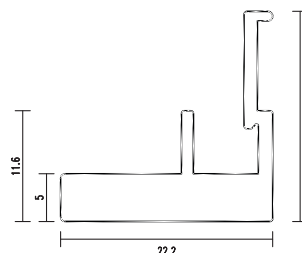

Size	MRP
300mm	960
350mm	1060
400mm	1160
450mm	1260
500mm	1360
600mm	1560
	Per Pc.

Curve Door Profile Handle

Product Code : SCDPH-03

Description : Use with SCDP-01
Material : Aluminium

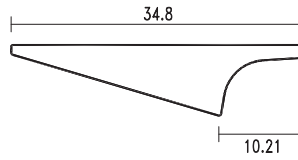

Finish	MRP 200mm	MRP 1200mm
Matt Black	690	2020
Matt Gold Brushed	690	2020
	Per Pc.	Per Pc.

Connector

Product Code : SCDPC-04

Description : With screws

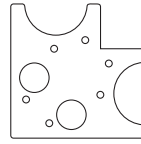

MRP
190
Per Set
(4 Pcs.)

SLIM PROFILE OPENABLE WARDROBE

Frame Profile

Product Code : SFP-25

Description : Width : 25mm Size : 3 Mtr.
Material : Aluminum

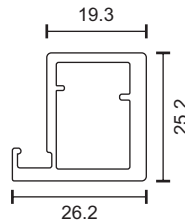

Finish	MRP
Matt Black	3175
Matt Gold Brushed	3175
	Per Pc.

Handle Frame Profile

Product Code : SHFP-25

Description : Use with SFP-25 Size : 3 Mtr.
Material : Aluminum

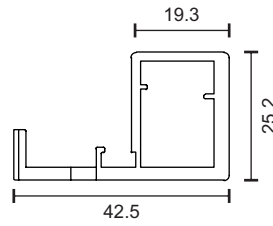

Finish	MRP
Matt Black	4175
Matt Gold Brushed	4175
	Per Pc.

Handle Frame Profile

Product Code : SHFP-26

Description : Use with SFP-25 Size : 3 Mtr.
Material : Aluminum

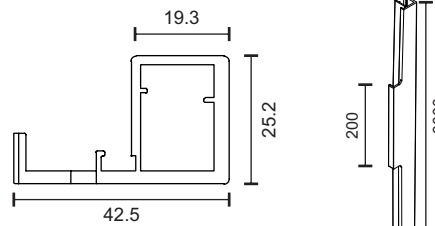

Finish	MRP
Matt Black	5850
Matt Gold Brushed	5850
	Per Pc.

Handle

Product Code : SFH-27

Description : Use with SFP-25
Material : Aluminium



Finish	MRP
Matt Black	2525
Matt Gold Brushed	2525
	Per Pc.

Air Concealed Soft Close Hinge

Description : One set 2 Pcs (R & L)
Weight Cap. : 20 kg.



MRP
4500
Per Set

Air Hinge Connector

Description : Use for SFP-25, SHFP-25, SHFP-26 Profile



MRP
675
Per Set
(4 Pcs.)

Soft Close Hinge

Product Code : HSC-26

Description : 3D Adjustment
Use for (25mm) Aluminium Profile



MRP
510
Per Set

Wardrobe Aluminum Pipe

Product Code : SAP-01

Description : with Gasket Size : 3 Mtr.
Material : Aluminum



Finish	MRP
Matt Black	1350

Edge Handle Profile

Product Code : SEP-08

Description : Size : 2.5 Mtr.
Material : Aluminum

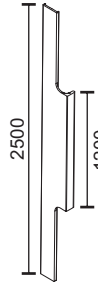
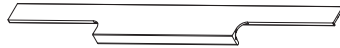

Finish	MRP
Matt Black	3350
Matt Rose Gold	3350

Edge Handle Profile

Product Code : SEP-09

Description : Left / Right, Size : 2.7 Mtr.
Material : Aluminum

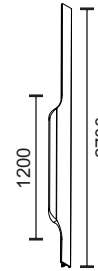
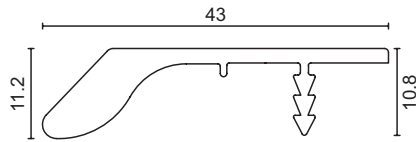

Finish	MRP
Matt Black	3550
Champagne	3550
Matt Gold Brushed	3550

Shutter Divider Profile

Product Code : Divider Profile

Description :
Front View 18.5mm, Size : 3 Mtr.
(use with SFP-45 & SHFP-45)

Material : Aluminum

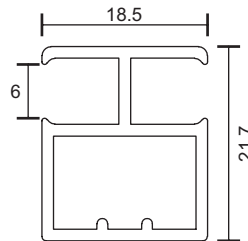

Finish	MRP
Matt Black	2060
Champagne	2060
Iron Grey	2060

J-End Cap Profile

Product Code : SEJP-38

Description : Use for Wooden Shutter Size : 3 Mtr.
Material : Aluminum

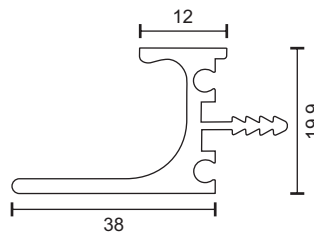

Finish	MRP
Matt Black	2450
Champagne	2450

G-Profile

Product Code : SGP-35

Description : Width : 35mm, Size : 3 Mtr.
Material : Aluminum

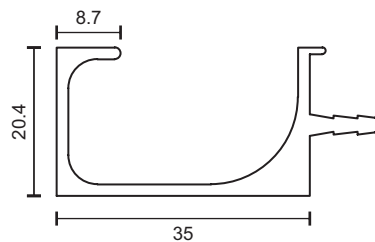

Finish	MRP
Aluminum	1950
Mirror	2450
Champagne	2450
Iron Grey	2450
Satin	2450
Matt Black	2450
Matt Rose Gold	2450
Gold	2450
Matt Gold Brushed	2450

G-End Cap Profile

Product Code : SGEP-35

Description : Width : 35mm, Size : 3 Mtr.
Material : Aluminum

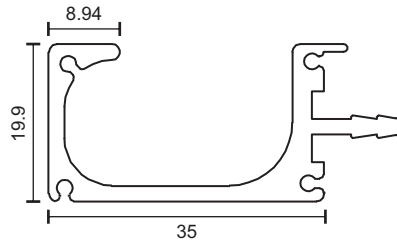

Finish	MRP
Aluminum	2490
Mirror	3090
Champagne	3090
Iron Grey	3090
Satin	3090
Matt Black	3090
Matt Rose Gold	3090

J-Profile

Description : Width : 38.5mm
Size : 3 Mtr.

Material : Aluminum

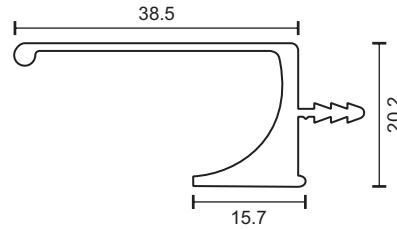

Finish	MRP
Mirror	2390
Champagne	2390
Iron Grey	2390

Frame Profile

Product Code : SFP-45

Description : width 45mm,
Inclusive of Gasket
Size : 3 Mtr.

Material : Aluminum

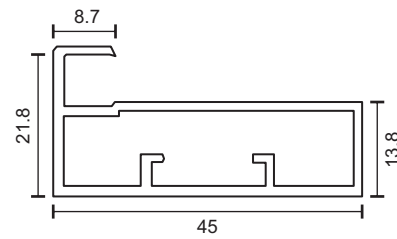

Finish	MRP
Aluminum	2075
Mirror	2575
Champagne	2575
Iron Grey	2575
Satin	2575
Matt Black	2575
Matt Rose Gold	2575
Gold	2575
Matt Gold Brushed	2575

Handle Frame Profile

Product Code : SHFP-45

Description : width 67.2mm,
Inclusive of Gasket (Use with SFP-45)
Size : 3 Mtr.

Material : Aluminum

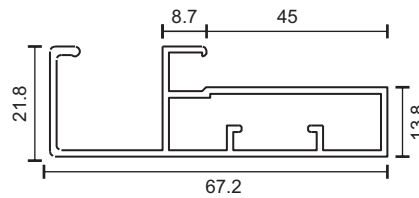

Finish	MRP
Aluminum	2875
Mirror	3425
Champagne	3425
Iron Grey	3425
satin	3425
Matt Black	3425
Matt Rose Gold	3425
Matt Gold Brushed	3425

Handle Frame Profile

Product Code : SHFP-65

Description : width 45mm,
Inclusive of Gasket (Use with SFP-45)
Size : 3 Mtr.

Material : Aluminum

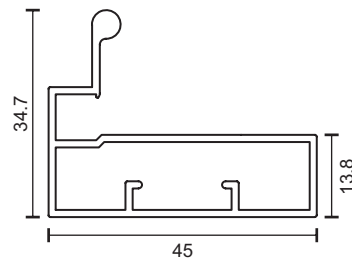

Finish	MRP
Champagne	3425
Iron Grey	3425
Matt Black	3425
Gold	3425

Rate Per Pc.

Handle Frame Profile

Product Code : SHFP-75

Description : Left / Right
Size : 3 Mtr.

Material : Aluminum

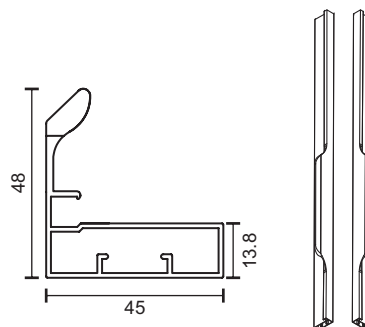

Finish	MRP
Matt Gold Brushed	4775
Matt Black	4775

Edge Handle Profile

Product Code : SP-021

Description : 35mm, Size : 3 Mtr.
Material : Aluminum

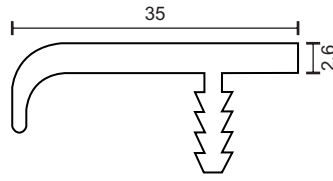

Finish	MRP
Aluminum	1725
Mirror	2125
Champagne	2125
Iron Grey	2125
Gold	2125

Edge Handle Profile

Product Code : SP-040

Description : 40mm, Size : 3 Mtr.
Material : Aluminum

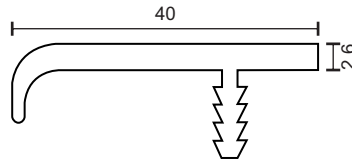

Finish	MRP
Satin	2225
Antique	2225

Edge Handle Profile

Product Code : SP-025

Description : Size : 3 Mtr.
Material : Aluminum

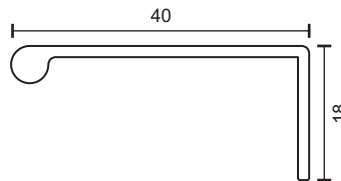

Finish	MRP
Champagne	1775
Iron Grey	1775

T-Profile

Product Code : STP-20

Description : Size : 3 Mtr.
Material : Aluminum

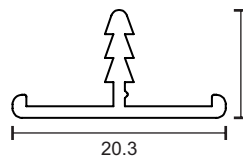

Finish	MRP
Champagne	560
Iron Grey	560

T-Profile

Product Code : STP-22

Description : Size : 3 Mtr.
Material : Aluminum

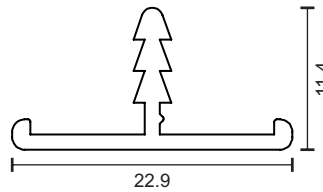

Finish	MRP
Aluminum	675
Mirror	925
Champagne	925
Iron Grey	925
Satin	925
Anthracite Grey	925
Antique	925
Matt Black	925
Matt Rose Gold	925
Gold	925

T-Profile

Product Code : STP-25

Description : Size : 3 Mtr.
Material : Aluminum

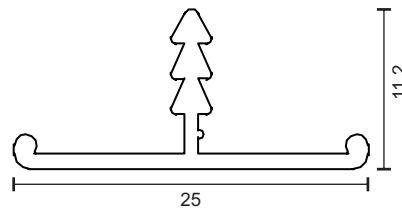

Finish	MRP
Aluminum	725
Mirror	975
Champagne	975
Iron Grey	975
Matt Black	975
Matt Rose Gold	975

Inlay

Product Code : INLAY 8MM

Description : 8mm, Size : 3 Mtr.
Material : Aluminum

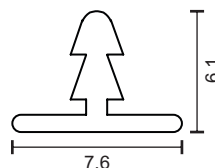

Finish	MRP
Champagne	310
Iron Grey	310
Matt Black	310
Gold	310

Inlay

Product Code : INLAY 12MM

Description : 12mm, Size : 3 Mtr.
Material : Aluminum

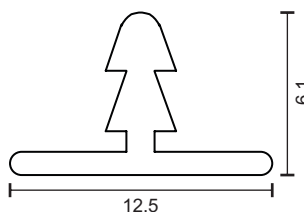

Finish	MRP
Champagne	410
Iron Grey	410
Matt Black	410
Gold	410

Edge Handle Profile

Product Code : SEP-10

Description : Size : 2.7 Mtr.
Material : Aluminum

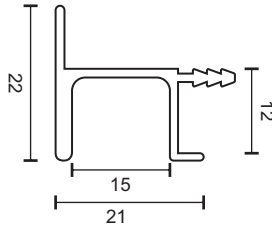

Finish	MRP
Champagne	1525
Iron Grey	1525
Matt Black	1525

J-Gola Profile

Product Code : J-Gola Profile

Description :
Use for Handle Less Doors & Shutters
Size : 3 Mtr.

Material : Aluminum

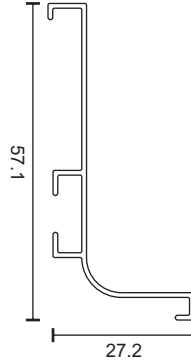

Finish	MRP
Matt Black	1760
Champagne	1760
Iron Grey	1760
Matt Rose Gold	1760

C-Gola Profile

Product Code : C-Gola Profile

Description :
Use for Handle Less Doors & Shutters
Size : 3 Mtr.

Material : Aluminum

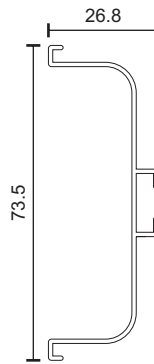

Finish	MRP
Matt Black	2110
Champagne	2110
Iron Grey	2110
Matt Rose Gold	2110

Overhead Cabinet Profile

Product Code : Overhead Cabinet Profile

Description :
Use for Handle Less Doors & Shutters
(Inclusive of Gasket)
Size : 3 Mtr.

Material : Aluminum

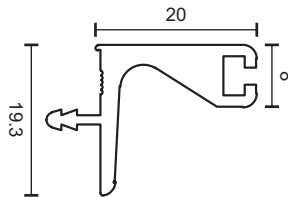

Finish	MRP
Matt Black	2440
Champagne	2440
Iron Grey	2440
Matt Rose Gold	2440

SMART MODULAR SHELVING PROFILES

Lateral Profile

Product Code : SMSPL-01

Description : Size : 3 Mtr.
Material : Aluminum

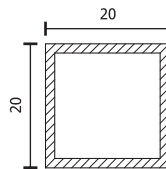

Finish	MRP
Matt Black	1450
Matt Gold Brushed	1450
	Per Pc.

Universal Profile

Product Code : SMSPU-02

Description : Size : 3 Mtr. inclusive of gasket
(Use for glass shelf)

Material : Aluminum

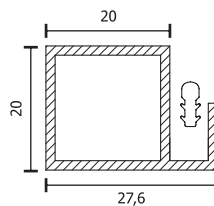

Finish	MRP
Matt Black	2250
Matt Gold Brushed	2250
	Per Pc.

Universal Profile

Product Code : SMSPU-03

Description : Size : 3 Mtr. (Use for wooden shelf)
Material : Aluminum

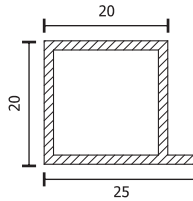

Finish	MRP
Matt Black	1550
Matt Gold Brushed	1550
	Per Pc.

Vertical Profile

Product Code : SMSPV-04

Description : Size : 3 Mtr.
Material : Aluminum

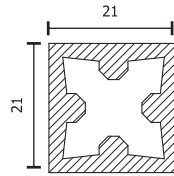

Finish	MRP
Matt Black	3150
Matt Gold Brushed	3150
	Per Pc.

Connector

Product Code : SMSPC-05

Description : Use with SMSPL-01, SMSPU-02,
SMSPU-03, SMSPV-04 (with Screw)
Material : Zinc

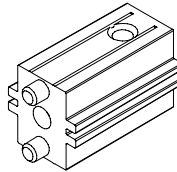

MRP
270
Per Set
(2 Pcs.)

Screw

Product Code : SMSPS-06

Description : 4 x 10mm
Material : S/S

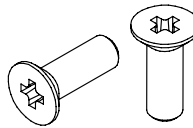

Finish	MRP
Matt Black	6
Matt Gold	6
	Per Pc.

PVC End Cap

Product Code : SMSPEC-07

Description : Use with SMSPV-04
Material : PVC

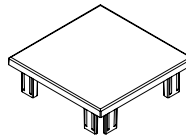

Finish	MRP
Matt Black	60
Matt Gold	60
	Per Set
	(2 Pcs.)

L-Connector

Description :
(Use for SFP-45 Profile,
SHFP-45 Profile)
Big size with screw



MRP
175
1 Set (4 Pcs.)

Air Hinge Connector

Description :
use for
SFP-25 Profile,
SHFP-25 Profile,
SHFP-26 Profile



MRP
675
1 Set (4 Pcs.)

Gola Profile Connector

Description :
use for
J-Gola Profile,
C-Gola Profile
(with screw)



MRP
135
1 Set (4 Pcs.)

Zinc End Cap

Description :
use for SGEP Profile



Finish **MRP**
CP 185
1 Set (2 Pcs.)

PVC End Cap

Description :
use for SGEP Profile



Finish **MRP**
Anodized 55
Rose Gold 65
Grey 65
Chrome 65
Satin 65
Antique 65
Black 65
1 Set (2 Pcs.)

J-End Cap

Description :
use for SEJP-38 Profile

Material : Zinc



Finish **MRP**
Matt Black 170
Matt Rose Gold 170
1 Set (2 Pcs.)

Divider Profile Connector

Description :
(Use for Divider Profile) with Screw



MRP
155
1 Set (2 Pcs.)

SAPB-01

Description :
Pipe Bracket (Use for SAP-01)



Finish **MRP**
Matt Black 350
1 Set (2 Pcs.)

Centre Support

Description :
Use for SAP-01



Finish **MRP**
Black 165
Per Pc.

U-Type Channel

Material : **S.S. 304**
Size : 2.5 Mtr.
Edge : 90° V-Cut
Finish : Rose Gold PVD, Gold PVD

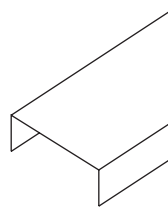

Size (mm)	MRP
10 x 5 x 10	1075
10 x 10 x 10	1075
10 x 20 x 10	1075
10 x 40 x 10	1525

T-Type Channel

Material : **S.S. 304**
Size : 2.5 Mtr.
Edge : 90° V-Cut
Finish : Rose Gold PVD, Gold PVD

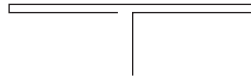

Size	MRP
8mm	1125
12mm	1325
19mm	1525

L-Type Channel

Material : **S.S. 304**
Size : 2.5 Mtr.
Edge : 90° V-Cut
Finish : Rose Gold PVD, Gold PVD

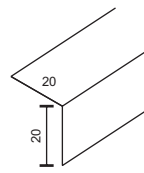

Size (mm)	MRP
20mm x 20mm	950

FURNITURE LIGHTING

LED Profile-01

Profile With Diffuser
Finish : Aluminum Matt
Size : 3 Mtr.

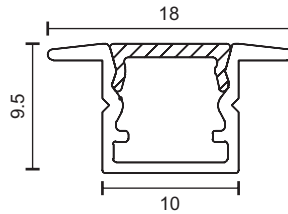

Size (mm)	MRP
18 x 9.5	775 Per Pc.

LED Profile-02

Profile With Diffuser
Finish : Aluminum Matt
Size : 3 Mtr.

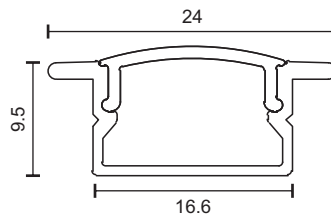

Size (mm)	MRP
24 x 9.5	975

LED Profile-03

Profile With Diffuser
Finish : Aluminum Matt
Size : 3 Mtr.

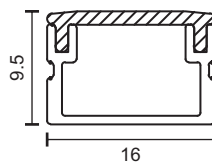

Size (mm)	MRP
16 x 9.5	975

LED Profile-04

Profile With Diffuser
Finish : Aluminum Matt
Size : 3 Mtr.

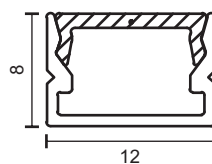

Size (mm)	MRP
12 x 8	690

LED Profile-05

Profile With Diffuser

Finish : Aluminum Matt
Size : 3 Mtr.

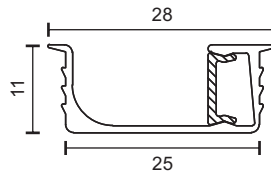

Size (mm)
28 x 11

MRP
850

LED Profile-06

Profile With Diffuser

Finish : Aluminum Matt
Size : 3 Mtr.

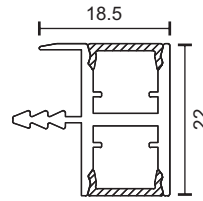

Size (mm)
18.5 x 22

MRP
1650

Switch

Finish : White



MRP
270
Per Pc.

Plug

Size : 1.5mtr Cable
(EU-Type)



MRP
950
Per Pc.

Distributor

Size : 0.2mtr Cable



MRP
375
Per Pc.

Membrane Switch

Size : 2mtr Cable



MRP
1025
Per Pc.

Membrane Controller

Size : 0.2mtr Cable



MRP
1025
Per Pc.

Light-01
Square

Colour : Milky White
Size : 2 mtr. Cable



MRP
800
Per Pc.

Light-02
Round

Colour : Milky White
Size : 2 mtr. Cable

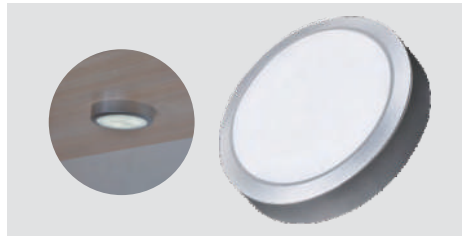

MRP
800
Per Pc.

LED Driver

Size : 1.5 mtr. Cable
EU Type
DC12V



MRP
1450
Per Pc.

WARDROBE ACCESSORIES

SWL-15KG

Soft Close Wardrobe Lifter

Size (mm) : 710 - 1160
Capacity : 15kg.



MRP
5510

SWF-05

Top Mounted Rotating Hanger

Finish : White+Chrome



MRP
4200

Pantry Roll Out

Description : 6 Basket
Finish : Upgrade Grey Glass
Type : Soft Close



Product Code	W x D x H	Carcase Size	MRP
PCPRO - 70712	405 x 500 x 1780mm	450mm	40500
PCPRO - 70713	555 x 500 x 1780mm	600mm	48500
			Per Set

Aircraft Carrier Cabin

Description : 5 Basket
Finish : Upgrade Grey Glass
Type : Soft Close



Product Code	W x D x H	Carcase Size	MRP
PCACC - 70714	(404 x 424) x 500 x 1780mm	450mm	62500
PCACC - 70715	(564 x 574) x 500 x 1780mm	600mm	72500
			Per Set

Magic Corner

Description :
Left Opening
Right Opening

Finish : Upgrade Grey Glass
Type : Soft Close



Product Code	W x D x H	Carcase Size	MRP
PCMC - 70711 (LEFT)	(860-960) x 530 x 520mm	900-1000mm	34200
PCMC - 70711 (RIGHT)	(860-960) x 530 x 520mm	900-1000mm	34200
			Per Set

Side Mounted Pullout

Description : 2 Basket
Finish : Upgrade Grey Glass
Type : Soft Close



Product Code	W x D x H	Carcase Size	MRP
PCSMP - 70716	135 x 485 x 580mm	200mm	10600
PCSMP - 70717	235 x 485 x 580mm	300mm	11600
			Per Pc.

Pantry Roll Out

Description : 6 Basket
Finish : Grey
Type : Soft Close



Product Code	W x D x H	Carcase Size	MRP
EPRO - 60612	405 x 500 x 1780mm	450mm	43500
EPRO - 60613	555 x 500 x 1780mm	600mm	51500
			Per Set

Aircraft Carrier Cabin

Description : 5 Basket
Finish : Grey
Type : Soft Close



Product Code	W x D x H	Carcase Size	MRP
EACC - 60614	(404-424) x 500 x 1780mm	450mm	64500
EACC - 60615	(554-574) x 500 x 1780mm	600mm	73500
			Per Set

Magic Corner

Description :
Left Opening
Right Opening

Finish : Grey
Type : Soft Close



Product Code	W x D x H	Carcase Size	MRP
EMC - 60611 (LEFT)	(860-960) x 530 x 520mm	900-1000mm	35500
EMC - 60611 (RIGHT)	(860-960) x 530 x 520mm	900-1000mm	35500
			Per Set

Multi Function Pullout

Description : 2 Basket
Finish : Grey
Type : Soft Close



Product Code	W x D x H	Carcase Size	MRP
EMFP - 60617	264 x 470 x 552mm	300mm	18500
			Per Pc.

Bottom Mounted Pullout

Description : 2 Basket
Finish : Grey
Type : Soft Close



Product Code	W x D x H	Carcase Size	MRP
EBMP - 60616	164 x 470 x 552mm	200mm	13500
			Per Pc.

**Oya
Cutlery Tray**

Finish : Grey



Product Code	Carcase Size	MRP
OCT - 450	450mm	2810
OCT - 600	600mm	4210

Per Pc.

S - Corner

Description : Right/Left
Finish : Grey
Type : Soft Closing



Product Code	MRP
SC - 01	15250

Per Set

DRAWERS

**Slim
Tandem Box**

Product Code : STB-01
Weight Capacity : 40 kg
Finish : Grey Matt



H x D	MRP	H x D	MRP	H x D	MRP
84 x 300mm	3425	167 x 300mm	3925	199 x 300mm	4425
84 x 350mm	3425	167 x 350mm	3925	199 x 350mm	4425
84 x 400mm	3425	167 x 400mm	3925	199 x 400mm	4425
84 x 450mm	3425	167 x 450mm	3925	199 x 450mm	4425
84 x 500mm	3425	167 x 500mm	3925	199 x 500mm	4425
84 x 550mm	3425	167 x 550mm	3925	199 x 550mm	4425

Per Set

**Glass
Tandem Box**

Product Code : GTB-02
Weight Capacity : 40 kg
Finish : Grey Matt +
Transparent Glass



H x D	MRP	H x D	MRP	H x D	MRP
84 x 400mm	4875	84 x 450mm	4875	84 x 500mm	4875
167 x 400mm	5500	167 x 450mm	5500	167 x 500mm	5500
199 x 400mm	6125	199 x 450mm	6125	199 x 500mm	6125

Per Set

**Front Connector
(L&R)**

Finish : Grey Matt



Product Code	Size	MRP
SFC-84	Height : 84mm	600
SFC-167	Height : 167mm	900
SFC-199	Height : 199mm	1025

Per Set

Front Panel

Finish : Grey Matt



Product Code	Size	MRP
SFP-1200	1200mm	1900

Per Pc.

Square Bar

Finish : Grey Matt



Product Code	Size	MRP
SSB-1200	1200mm	750

Per Pc.



Full Glass Front Connector (L&R)

Finish : Grey Matt



Product Code	Size	MRP
FG-FC-84	Height : 84mm	600
FG-FC-167	Height : 167mm	900
FG-FC-199	Height : 199mm	1025
		Per Set

Front Panel

Finish : Grey Matt



Product Code	Size	MRP
GFP-1200	1200mm	1375
		Per Pc.

Half Glass Front Connector (L&R)

Finish : Grey Matt



Product Code	Size	MRP
HG-FC-167	Height : 167mm	900
HG-FC-199	Height : 199mm	1025
		Per Set

Front Panel

Finish : Grey Matt



Product Code	Size	MRP
GFP-1200	1200mm	1375
		Per Pc.

Non-Slip Drawer Mat

Product Name : Non-Slip Drawer Mat

Colour : Dark Grey

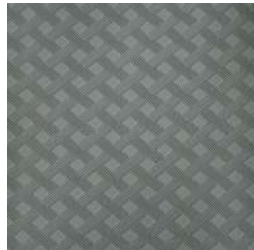

NON-SLIP DRAWER MAT

Size	MRP
10Mtrs (L) x 500mm (H)	4550
20Mtrs (L) x 500mm (H)	9100
	Per Roll

Pocket Door Sliding

Product Code : SPDS - LEFT
Product Code : SPDS - RIGHT
Weight Cap. : 50 Kg.
(One Door Max.)

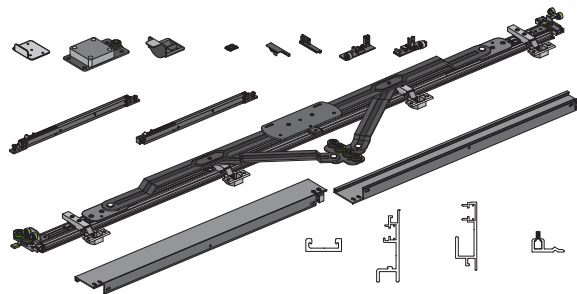

LEFT
RIGHT

MRP
112000
112000
Per Set (1 Door Fitting)

Soft Close Sliding Fitting

Product Code : SSR-609
Weight Cap. : 50 Kg.
(One Door Max.)



Type	MRP
2 Door Kit	4700
	Per Box

Soft Close Sliding Fitting

Product Code : SSR-709
Weight Cap. : 50 Kg.
(One Door Max.)



Type	MRP
2 Door Kit	6400
3 Door Kit	8300
	Per Box

Sliding Channel

Product Code : SSC-609
Description : (Top & Bottom)
(Use with SSR-609 / SSR-709)
Finish : Aluminium

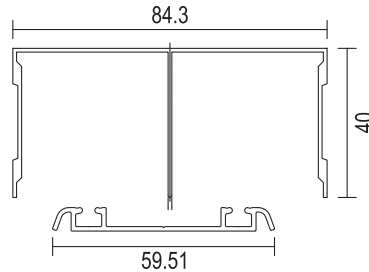

Size	MRP
2.5mtr.	3500
3.97mtr.	5525
	Per Set

Soft Close Sliding Fitting

Product Code : SSR-409
Weight Cap. : 50 Kg.
(One Door Max.)

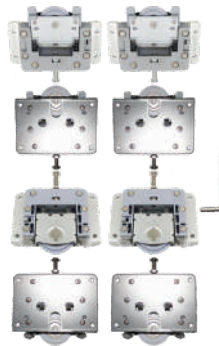

Type	MRP
2 Door Kit	2475
	Per Set

Soft Close Sliding Fitting

Product Code : SSR-509
Weight Cap. : 50 Kg.
(One Door Max.)



Type	MRP
2 Door Kit	2475
	Per Set

Soft Close Dampener

Use with SSR-409 / SSR-509



MRP
375
Per Pc.

Sliding Channel

Product Code : SSC-409
(Use with SSR-409 / SSR-509)

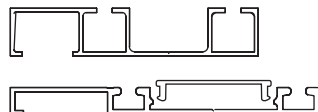

Size	Anodized	Matt black	Champagne	Iron grey
2.43mtr. (8ft)	3200	3950	3950	3950
3.66mtr. (12ft)	4800			
				Per Set



for installation video
please scan barcode

Soft Close Sliding Fitting

Product Code : SSR-602
Weight Cap. : 80 Kg.
(One Door Max.)

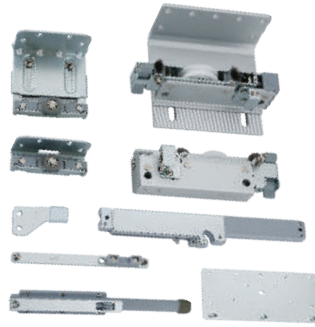

Type	MRP
2 Door Kit	12100
3 Door Kit	17250
	Per Set

Sliding Channel

Product Code : SSC-602
(Use with SSR-602)



for installation video
please scan barcode

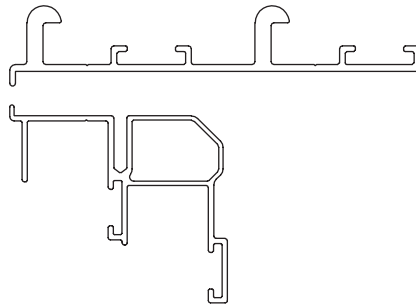

Size	Aluminium
3mtr. (10ft)	5050
3.66mtr. (12ft)	6060
	Per Set

Sliding Roller

Product Code : SSR-04/08



Size	MRP
4 Wheel	1280
8 Wheel	1720
	Per Set

Sliding Channel

Product Code : SSC-04/08
(Use with SSR-04/08)
Finish : Aluminium



Size	MRP
12 ft	4410
13 ft	4778
16 ft	5880
	Per Pc.

Sliding Roller

Product Code : SSR-01



Type	MRP
2 Door Kit	475
	Per Box

Sliding Channel

Product Code : SSC-01
(Use with SSR-01)
Finish : Aluminium



Size	MRP
10 ft	650
12 ft	780
	Per Pc.

WOODEN DOOR TELESCOPIC / SYNCHRONIZE SLIDING

Sliding Channel

Product Code : SSC-14
Finish : Matt Black

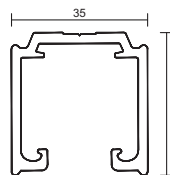

Size	MRP
3 Mtr	4500
3.97 Mtr	5850
	Per Pc.

Track Cover

Product Code : SSTC-14
Finish : Matt Black

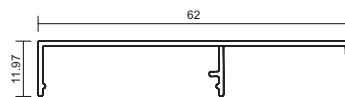

Size	MRP
3 Mtr	1500
3.97 Mtr	1950
	Per Pc.

Heavy Sliding Channel

Product Code : SSC-12
Finish : Matt Black

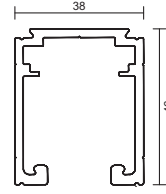

Size	MRP
3 Mtr	5500
3.97 Mtr	7150
	Per Pc.

Track Cover

Product Code : SSTC-12
Finish : Matt Black

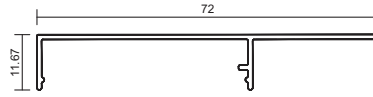

Size	MRP
3 Mtr	1750
3.97 Mtr	2275
	Per Pc.

Telescopic Sliding Roller

Product Code : SSR-314 (1+2)
Product Code : SSR-314 (1+3)
Description : Both Side Soft Close
Weight Cap. : 80 Kg.

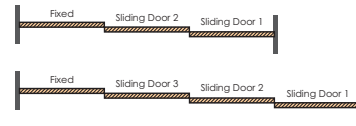

	MRP
(1+2)	18250
(1+3)	23250
	Per Pair

Telescopic Sliding Roller

Product Code : SSR-315 (1+2)
Product Code : SSR-315 (1+3)
Description : Both Side Soft Close
Weight Cap. : 120 Kg.

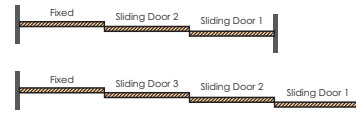

	MRP
(1+2)	23250
(1+3)	28250
	Per Pair

Synchronize Roller

Product Code : SSR-414
Description : Both Side Soft Close
Weight Cap. : 80 Kg.

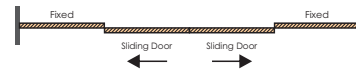

	MRP
	18250
	Per Pair

Synchronize Roller

Product Code : SSR-415
Description : Both Side Soft Close
Weight Cap. : 120 Kg.



	MRP
	23250
	Per Pair

SLIDING FITTINGS

Heavy Door Sliding Fitting

Product Code : SSR-10
Type : Without S/C
Weight Cap. : 80 - 120 Kg.
(One Door Max.)



	MRP
	2850
	Per Pair

Soft Close Heavy Door Sliding Fitting

Product Code : SSR-11
Type : 1 Side Soft Close
Weight Cap. : 80 - 120 Kg.
(One Door Max.)



	MRP
	5600
	Per Pair

Soft Close Heavy Door Sliding Fitting

Product Code : SSR-12
Type : Both Side Soft Close
Weight Cap. : 80 - 120 Kg.
(One Door Max.)



	MRP
	7050
	Per Pair

Heavy Sliding Channel

Product Code : SSC-10/11/12
Finish : Aluminium
Description : Use with SSR-10, 11, 12

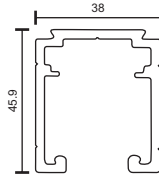

Size	MRP
2.43mtr. (8ft)	4120
3.97mtr. (13ft)	6695
	Per Pc.

Noise Less Sliding Door Fitting

Product Code : SSR-13
Type : Both Side Soft Close
Weight Cap. : 60 - 80 Kg.
(One Door Max.)



MRP
4600
Per Pair

Sliding Channel

Product Code : SSC-13
Finish : Aluminium
Description : Use with SSR-13

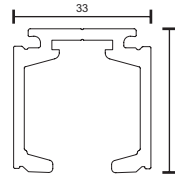

Size	MRP
2.43mtr. (8ft)	3360
3.97mtr. (13ft)	5460
	Per Pc.

BATHROOM ACCESSORIES



Product Code : SMR-01
Description : Magnifying Mirror
Material : Brass
MRP 2850



Product Code : SMR-03
Description : Magnifying Mirror with LED
Material : Brass
MRP 8500

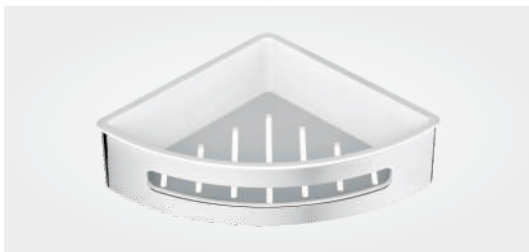

Prod. Code : 7009 Size : 206 x 206 x 56 MRP : 2475
Prod. Code : 7010 Size : 245 x 245 x 55 MRP : 2875
Description : SS Corner
Material : SS 304 + ABS



Prod. Code : 7011 Size : 290 x 123 x 56 MRP : 2475
Prod. Code : 7012 Size : 350 x 123 x 55 MRP : 2875
Description : SS Front Shelf
Material : SS 304 + ABS

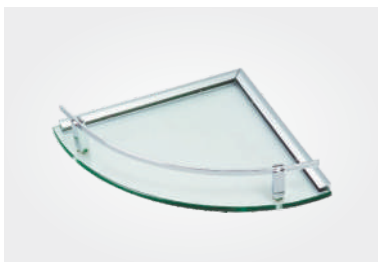

Product Name : Glass Corner
Description : Toughened
Size : 10" x 10" MRP 1750
Size : 12" x 12" MRP 1950



Product Name : Glass Shelf
Description : Toughened
Size : 16" MRP 2100
Size : 20" MRP 2300



Product Code : 7004
Description : Foot Rest with Hook
Material : Brass MRP 4250



Product Code : SCH-2003
SCH-2006
Finish : Satin Nickel

Size	MRP
3 Pin	390
6 Pin	705



Product Code : SCH-1002
SCH-1004
Finish : Satin Nickel

Size	MRP
2 Pin	390
4 Pin	705



Product Code : SCH-4006
Finish : Chrome

Size	MRP
2 Pin	350
4 Pin	700
6 Pin	1050



Product Code : SCH-5006
Finish : White+CP

Size	MRP
2 Pin	390
4 Pin	780
6 Pin	1170



Product Code : SCH-6000
Finish : Chrome

Size	MRP
4 Pin	520
6 Pin	780



Product Code : SCH-6100
Finish : Satin + Black

Size	MRP
4 Pin	640
6 Pin	960



Product Code : SCH-6200
Finish : Grey + RG PVD

Size	MRP
4 Pin	750
6 Pin	1125



Product Code : SCH-6300
Finish : SS Matt

Size	MRP
4 Pin	540
6 Pin	810

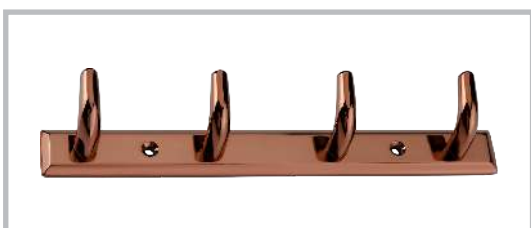

Product Code : SCH-6400
Finish : Rose Gold PVD

Size	MRP
4 Pin	920
6 Pin	1380



Product Code : SCH-6500
Finish : Antique, Black

Size	MRP
4 Pin	640
6 Pin	960



Product Code : SCH-6600
Finish : Gold PVD, Rose Gold PVD

Size	MRP
4 Pin	940
6 Pin	1410

S/S PIPES

Round Pipe 19mm

Product Code : SSP-19
Material : Stainless Steel
Finish : Chrome



Size	MRP
12 ft	900

Round Pipe 25mm

Product Code : SSP-25
Material : Stainless Steel
Finish : Chrome, Satin



Size	MRP
12 ft	1260

Oval Pipe 15 x 30mm

Product Code : SSP-30
Material : Stainless Steel
Finish : Chrome, Satin



Size	MRP
12 ft	1290

HINGES

Product Code : HSC-20
Description : Soft Close Hinge (Slide on)
Size : 0 / 8 / 15 Crank



MRP
185

Per Set

Product Code : HSC-25
Description : Soft Close Hinge, 3D Adjustment.
Use for **(20-22mm)** Aluminium Profile
Size : Full Overlay



MRP
460

Per Set

Product Code : HSC-26
Description : Soft Close Hinge, 3D Adjustment.
Use for **(25mm)** Aluminium Profile
Size : Full Overlay



MRP
510

Per Set

Product Code : HSC-30
Description : 3D Adjustment (2 way-small angle soft close)
Size : 0 / 8 / 15 Crank
Finish : Gun Black



MRP
410

Per Set

Product Code : HSC-35
Description : Soft Close Hinge, 3D Adjustment
Size : 0 / 8 / 15 Crank



MRP
360

Per Set

Product Code : HSC-40
Description : Soft Close Hinge, Thick Door (16-30mm)
Size : 0 / 8 / 15 Crank



MRP
490

Per Set

Product Code : HSC-45
Description : Blind Soft Close Hinge 45°



MRP
475

Per Set

Product Code : HSC-90
Description : Blind Soft Close Hinge 90°



MRP
475

Per Set

Product Code : Z-90
Description : Pie/Bio Hinge



MRP
280

Per Set

Product Code : HSC-165
Description : Corner Soft Close Hinge



MRP
850

Per Set

Product Code : HSC-S/S 304 (3D)
Description : 3D-S/S Soft Close Hinge
Size : 0 / 8 / 15 Crank



MRP
540

Per Set

Product Code : HSC-S/S 304A
Description : S/S Soft Close Hinge
Size : 0 / 8 / 15 Crank



MRP
425
Per Set

Product Name : Air Concealed Soft Close Hinges
Description : One Set 2 Pcs (Right & Left)
Weight Cap. : 20 kg



MRP
4500
Per Set

Product Name : Air Hinge - Cover
Description : One Set 2 Pcs (Right & Left)



MRP
1120
Per Set

Full Extension
Synchronize
Soft Close Quadro



Product Code	Size	MRP
SFSQ -10"	10" (250mm)	1665
SFSQ -12"	12" (300mm)	1715
SFSQ -14"	14" (350mm)	1765
SFSQ -16"	16" (400mm)	1815
SFSQ -18"	18" (450mm)	1865
SFSQ -20"	20" (500mm)	1915
SFSQ -22"	22" (550mm)	1965
SFSQ -24"	24" (600mm)	2065

Per Pair

DRAWER SLIDES

Telescopic Slide

Finish : Zinc



Size	MRP
8"	325
10"	325
12"	390
14"	455
16"	520
18"	585
20"	650
22"	715
24"	780

Per Pair

Black
Telescopic Slide

Finish : Black



Size	MRP
10"	325
12"	390
14"	455
16"	520
18"	585
20"	650
22"	715
24"	780

Per Pair

Heavy Duty Telescopic Slide (53mm)

Finish : Zinc



Size	MRP
14"	1260
16"	1440
18"	1620
20"	1800
22"	1980
24"	2160
28"	2520
30"	2700
32"	2880
34"	3060
36"	3240
42"	3780
Per Pair	

Soft Close Telescopic Slide

Finish : Zinc



Size	MRP
10"	660
12"	660
14"	770
16"	880
18"	990
20"	1100
22"	1210
Per Pair	

Stainless Steel Slide

Finish : S.S. (Grade : SS 201)



Size	MRP
12"	660
14"	770
16"	880
18"	990
20"	1100
Per Pair	

WARDROBE & DRAWER LOCKS

Wardrobe Lock

Product Code : WRDL

Description : Dimple key, Brass Bolt, Brass key

Finish : SS



Size	MRP
25mm	660
30mm	685
35mm	740
Per Pc.	

Drawer Lock

Product Code : DRWL

Description : Dimple key, Brass Bolt, Brass key

Finish : SS



Size	MRP
20mm	485
25mm	515
Per Pc.	

FURNITURE FITTINGS

Bio Fold Lift Up

Product Code : SBFL-121

Description : Use for Double Door

Weight Cap. : 7 - 8.5 kg



Cabinet Size (mm)	MRP
H W T	7900
700 x 900 x 18	Per Pair
700 x 1000 x 18	
800 x 800 x 18	
800 x 900 x 18	

Bio Fold Lift Up

Product Code : SBFL-125
Description : Use for Double Door
Weight Cap. : 5.5 - 7 kg



Cabinet Size (mm)

H W T
600 x 800 x 18
600 x 900 x 18
600 x 1000 x 18

MRP
7900
Per Pair

Cabinet Stay

Product Code : SHS -122
Description : Use for Single Door
Weight Cap. : 4 - 5 kg



MRP
1350
Per Pc.

Lift Up Fitting

Product Code : SSFL -126
Description : Use for Single Door
(Soft Close)
Weight Cap. : 4.5 - 6 kg



MRP
4650
Per Pair

Product Code : SHK-80/120
Description : Gas Spring for Bed
Size : 600mm



Weight Cap. MRP
80 kg 850
120 kg 850
Per Pc.

Product Code : SHK-175
Description : Gas Spring
Size : 335mm



Weight Cap. MRP
35 kg 650
Per Pc.

Product Code : SHK-167
Description : Gas Spring



Weight Cap. MRP
5kg, 10kg, 15kg, 20kg 215
Per Pc.

Product Code : SHK-150
Description : Gas Spring



Weight Cap. MRP
5kg, 10kg, 15kg, 20kg 160
Per Pc.

Product Code : SHK-155
Description : Soft Close Gas Spring



Weight Cap. MRP
5kg, 10kg, 15kg, 20kg 275
Per Pc.

Product Code : SHS -123
Description : Cabinet Stay



Weight Cap. MRP
15 kg One Set 690
Per Pair

Product Code : SHS -124
Description : Cabinet Stay



Weight Cap. MRP
15 kg One Set 690
Per Pair

Product Name : Soft Close Dampener
Description : For Telescopic Channel



MRP
270
Per Set

Product Code : SPO-131
Description : Push to Open



MRP
125
Per Pc.

Product Code : Bed Fitting 03
Description : Frame with Gas Spring
Size : 1.5 mtr.



Weight Cap.	MRP
125 kg	4450
150 kg	4450
175 kg	4450
200 kg	4450
	Per Set

Extra Gas Spring

1600
Per Set

Product Code : SFL-113
Description : Furniture Leg
Material : Aluminium
Finish : Chrome



Size	MRP
3"	475
4"	550
6"	720
	PerPc.

Product Code : SFL-114
Description : Furniture Leg
Material : Aluminium
Finish : Chrome



Size	MRP
3"	475
4"	550
6"	720
	PerPc.

Product Code : SFL-115
Description : Furniture Leg
Height : 50mm



Finish	MRP
Chrome	220
PVD Rose Gold	220
PVD Black Chrome	220
	PerPc.

Product Code : SFL-115
Description : L - Type Furniture Leg
Height : 50mm



Finish	MRP
Chrome	325
PVD Rose Gold	325
PVD Black Chrome	325
	PerPc.

Product Code : SFL-116
Description : Furniture Leg
Height : 100mm



Finish	MRP
SS Matt + CP	760
Black Matt + Gold	760
RG Matt + RG	760
	PerPc.

Product Code : SFL-117
Description : Furniture Leg



Finish	2"	3"	4"
Chrome	155	190	225
PVD Rose Gold	185	230	280
PVD Gold	185	230	280
			PerPc.

Product Code : SFL-118
Description : Furniture Leg
Material : Aluminium
Finish : Black+Gold PVD, Rose Gold PVD+Black



Size	MRP
100mm	990
150mm	1590
200mm	2120
	PerPc.

Product Code : SMDS-01
Description : Magnet Door Stopper
Material : Zinc
Finish : SS, Antique, Matt Grey



MRP
510
Per Pc.

Product Code : SMDS-02
Description : Magnet Door Stopper
Material : Zinc
Finish : SS, Antique, Matt Grey



MRP
510
Per Pc.

Product Name : Indicating Bolt
Material : Zinc
Finish : Satin Nickle



MRP
525
Per Pc.

Product Name : Baby Latch Big
Material : Zinc
Finish : Satin Nickle

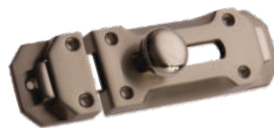

MRP
440
Per Pc.

Product Code : SCM-134
Description : Round Cable Manager
Material : Zinc
Finish : BSN



MRP
240
Per Pc.

Description : Square Cable Manager
Material : Aluminium
Finish : BSN



Product Code	Size	MRP
SCM-132	80 x 80mm	610
SCM-133	80 x 150mm	740
		Per Pc.

Product Code : D-Stopper
Material : Zinc
Finish : BSN



MRP
140
Per Pc.

Product Code : SAVF
Description : Ventilation Frame
Material : Aluminium



Size	Alu.	SS Brus.	Chrome
80 x 150	220	230	300
80 x 200	270	310	395
80 x 300	370	420	540
80 x 400	470	510	730

Product Name : Window Seal
Size : 6mtr.



Finish	MRP
White	340
Brown	340
	Per Box

Product Name : Brush Seal
Description : with 3M Tape
Size : 7 x 8mm (10mtr.)



Finish	MRP
Grey	395
	Per Box

Product Code : SDV-10
Finish : Satin Nickel, Antique
Description : Door Thickness 35-60mm



MRP
425
Per Pc.

Product Code : SDV-20
Finish : Satin Nickel, Antique
Description : Door Thickness 35-60mm



MRP
580
Per Pc.

Product Code : SPB-19/25
Description : Round Pipe Bracket
Finish : Chrome



Size	MRP
19mm	125
25mm	165
	Per Set

Product Code : SB-03
Description : Shelf Button
Finish : Chrome



MRP
22
Per Pc.

Product Code : SB-04
Description : Shelf Button
Finish : Chrome



MRP
30
Per Pc.

Product Code : SB-08
Description : Shelf Button
Finish : Chrome



MRP
45
Per Pc.

Product Code : SOB-135
Description : Oval Pipe Bracket
Finish : Chrome



MRP
45
Per Set

Product Code : SOB-140
Description : Oval Pipe Bracket
Finish : Chrome



MRP
95
Per Set





www.starrs.in

sales.starrs@gmail.com