

# ST★RRS<sup>®</sup>

Premium Hardware Fitting

I N S P I R I N G - E X P R E S S I V E - F U N C T I O N A L

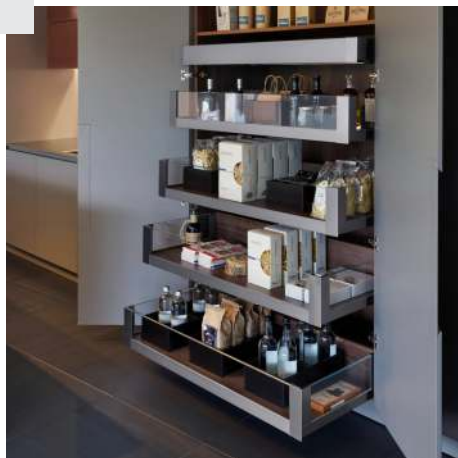

The idea to offer high quality furniture, kitchen & bathroom fittings with reliable services kicked in the year 2009, when Starrs Hardware came into being. From there on it has been a progressive climb in the graph when it comes to user reviews, customer satisfaction and of course the sales figures. Our products not only complement the beauty and functionality of your home and workplace essentials, but also add to their life.



**STARRS**<sup>®</sup>  
Premium Hardware Fitting



feel the  
confidence  
that comes from  
seeing things  
for yourself







# CONTENTS

**MORTISE HANDLES**

Page 06

**LOCK BODY & CYLINDER**

Page 12

**PULL HANDLES**

Page 14

**CABINET HANDLES**

Page 20

**KIDS HANDLES & KNOBS**

Page 24

**CONCEALED HANDLES**

Page 25

**SLIDING SYSTEMS / PROFILES**

Page 29

**PROFILES ACCESSORIES**

Page 61

**DECORATIVE U,L & T CHANNEL**

Page 62

**FURNITURE LIGHTING**

Page 64

**WARDROBE ACCESSORIES**

Page 68

**HIGH END KITCHEN STORAGE**

Page 69

**DRAWERS**

Page 81

**NON-SLIP DRAWER MAT**

Page 86

**SLIDING FITTINGS**

Page 87

**BATHROOM ACCESSORIES**

Page 97

**CLOTH HOOKS**

Page 98

**SS PIPES**

Page 100

**HINGES**

Page 101

**DRAWER SLIDES**

Page 104

**WARDROBE & DRAWER LOCK**

Page 107

**FURNITURE FITTINGS**

Page 108

## Transmission Sunlight

A bunch of sunlight is penetrated in, docked on the window decorations, the smart jumping light particles, are my most pious waiting

## MORTISE HANDLES

Our design and engineering workmanship shows through the intricate detailing all over Starrs Mortise Handles. Rich design with clean lines and subtle curves lends them an elegant look and tactile feel that effortlessly make an impression on visitors. Alluring simplicity and smart design make the collection suitable for modern as well as contemporary interiors.





Satin+CP



Black M.+Rose Gold



CRG Matt+Black

|                     |          |                    |                |  |
|---------------------|----------|--------------------|----------------|--|
| <b>PRODUCT CODE</b> | SMH-12   |                    |                |  |
| <b>MATERIAL</b>     | SS 304   |                    |                |  |
| <b>FINISH</b>       | Satin+CP | Black M.+Rose Gold | CRG Matt+Black |  |



SS Matt+CP



Rose Gold PVD+Grey



Grey+Gold-PVD

|                     |            |                    |               |  |
|---------------------|------------|--------------------|---------------|--|
| <b>PRODUCT CODE</b> | SMH-13     |                    |               |  |
| <b>MATERIAL</b>     | Zinc       |                    |               |  |
| <b>FINISH</b>       | SS Matt+CP | Rose Gold PVD+Grey | Grey+Gold-PVD |  |





CP+SS Matt



Rose Gold PVD+Grey



Grey+Gold-PVD

|                     |            |                    |               |  |
|---------------------|------------|--------------------|---------------|--|
| <b>PRODUCT CODE</b> | SMH-14     |                    |               |  |
| <b>MATERIAL</b>     | Zinc       |                    |               |  |
| <b>FINISH</b>       | CP+SS Matt | Rose Gold PVD+Grey | Grey+Gold-PVD |  |



CP+SS Matt



Matt Antique+Grey



PVD-RG+Grey Matt



PVD-Grey+Grey Matt

|                     |            |                     |                  |                    |
|---------------------|------------|---------------------|------------------|--------------------|
| <b>PRODUCT CODE</b> | SMH-15     |                     |                  |                    |
| <b>MATERIAL</b>     | Zinc       |                     |                  |                    |
| <b>FINISH</b>       | CP+SS Matt | Matt Antique + Grey | PVD-RG+Grey Matt | PVD-Grey+Grey Matt |



SS+Grey



Black+Gold-PVD



Grey+Rose Gold-PVD

|                     |         |                |                    |  |
|---------------------|---------|----------------|--------------------|--|
| <b>PRODUCT CODE</b> | SMH-16  |                |                    |  |
| <b>MATERIAL</b>     | Zinc    |                |                    |  |
| <b>FINISH</b>       | SS+Grey | Black+Gold-PVD | Grey+Rose Gold-PVD |  |



SS+CP



Antique+Grey



Rose Gold PVD+Wood



Black+Black PVD

|                     |        |              |                    |                 |
|---------------------|--------|--------------|--------------------|-----------------|
| <b>PRODUCT CODE</b> | SMH-17 |              |                    |                 |
| <b>MATERIAL</b>     | Zinc   |              |                    |                 |
| <b>FINISH</b>       | SS+CP  | Antique+Grey | Rose Gold PVD+Wood | Black+Black PVD |





SS+CP



Antique+Gold PVD



Black+Black PVD



Rose Gold PVD+Black

|                     |        |                  |                 |                     |
|---------------------|--------|------------------|-----------------|---------------------|
| <b>PRODUCT CODE</b> | SMH-18 |                  |                 |                     |
| <b>MATERIAL</b>     | Zinc   |                  |                 |                     |
| <b>FINISH</b>       | SS+CP  | Antique+Gold PVD | Black+Black PVD | Rose Gold PVD+Black |



SS+Grey



Black+Gold PVD



Grey+Rose Gold PVD

|                     |                    |                |                    |  |
|---------------------|--------------------|----------------|--------------------|--|
| <b>PRODUCT CODE</b> | SMH-16 (10" Plate) |                |                    |  |
| <b>MATERIAL</b>     | Zinc               |                |                    |  |
| <b>FINISH</b>       | SS+Grey            | Black+Gold PVD | Grey+Rose Gold PVD |  |





SS+CP



Black+Black PVD



Antique+Grey

|                     |                    |                 |              |  |
|---------------------|--------------------|-----------------|--------------|--|
| <b>PRODUCT CODE</b> | SMH-17 (10" Plate) |                 |              |  |
| <b>MATERIAL</b>     | Zinc               |                 |              |  |
| <b>FINISH</b>       | SS+CP              | Black+Black PVD | Antique+Grey |  |



SS+CP



Black+Black PVD



Antique+Gold PVD

|                     |                    |                 |                  |  |
|---------------------|--------------------|-----------------|------------------|--|
| <b>PRODUCT CODE</b> | SMH-18 (10" Plate) |                 |                  |  |
| <b>MATERIAL</b>     | Zinc               |                 |                  |  |
| <b>FINISH</b>       | SS+CP              | Black+Black PVD | Antique+Gold PVD |  |

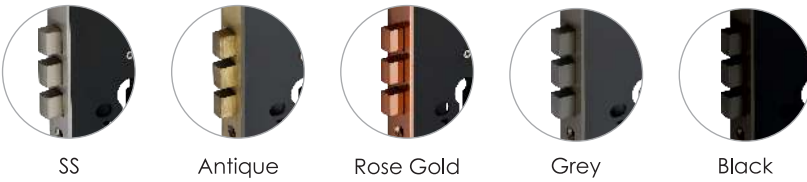

|                     |                                    |         |           |      |       |
|---------------------|------------------------------------|---------|-----------|------|-------|
| <b>PRODUCT CODE</b> | SLB-10"                            |         |           |      |       |
| <b>DIMENSION</b>    | 45mm Backset, 85mm Centre Distance |         |           |      |       |
| <b>FINISH</b>       | SS                                 | Antique | Rose Gold | Grey | Black |

- Hardened Brass Bolt
- Double Stroke Bolt Operation for Strong Grip
- SS Strike Plate
- Suggested Application for Front & Inside Door



|                     |                                    |  |  |  |  |
|---------------------|------------------------------------|--|--|--|--|
| <b>PRODUCT CODE</b> | SLB-20"                            |  |  |  |  |
| <b>DIMENSION</b>    | 45mm Backset, 85mm Centre Distance |  |  |  |  |
| <b>FINISH</b>       | SS                                 |  |  |  |  |

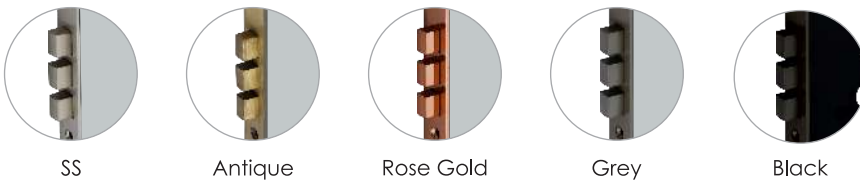

|                     |                                    |         |           |      |       |
|---------------------|------------------------------------|---------|-----------|------|-------|
| <b>PRODUCT CODE</b> | SLB-30"                            |         |           |      |       |
| <b>DIMENSION</b>    | 60mm Backset, 85mm Centre Distance |         |           |      |       |
| <b>FINISH</b>       | SS                                 | Antique | Rose Gold | Grey | Black |



|                |                     |         |           |      |       |
|----------------|---------------------|---------|-----------|------|-------|
| <b>P. CODE</b> | Both Side Key (BSK) |         |           |      |       |
| <b>SIZE</b>    | 60mm, 70mm, 80mm    |         |           |      |       |
| <b>FINISH</b>  | SS                  | Antique | Rose Gold | Grey | Black |

|                |                                |         |           |                |                           |               |    |         |           |      |       |
|----------------|--------------------------------|---------|-----------|----------------|---------------------------|---------------|----|---------|-----------|------|-------|
| <b>P. CODE</b> | 1 Side Knob + 1 Side Key (OSK) |         |           | <b>P. CODE</b> | 1 Side Coin + 1 Side Knob |               |    |         |           |      |       |
| <b>SIZE</b>    | 60mm, 70mm, 80mm               |         |           | <b>SIZE</b>    | 60mm, 70mm, 80mm          |               |    |         |           |      |       |
| <b>FINISH</b>  | SS                             | Antique | Rose Gold | Grey           | Black                     | <b>FINISH</b> | SS | Antique | Rose Gold | Grey | Black |



**STARRS**<sup>®</sup>  
Premium Hardware Fitting

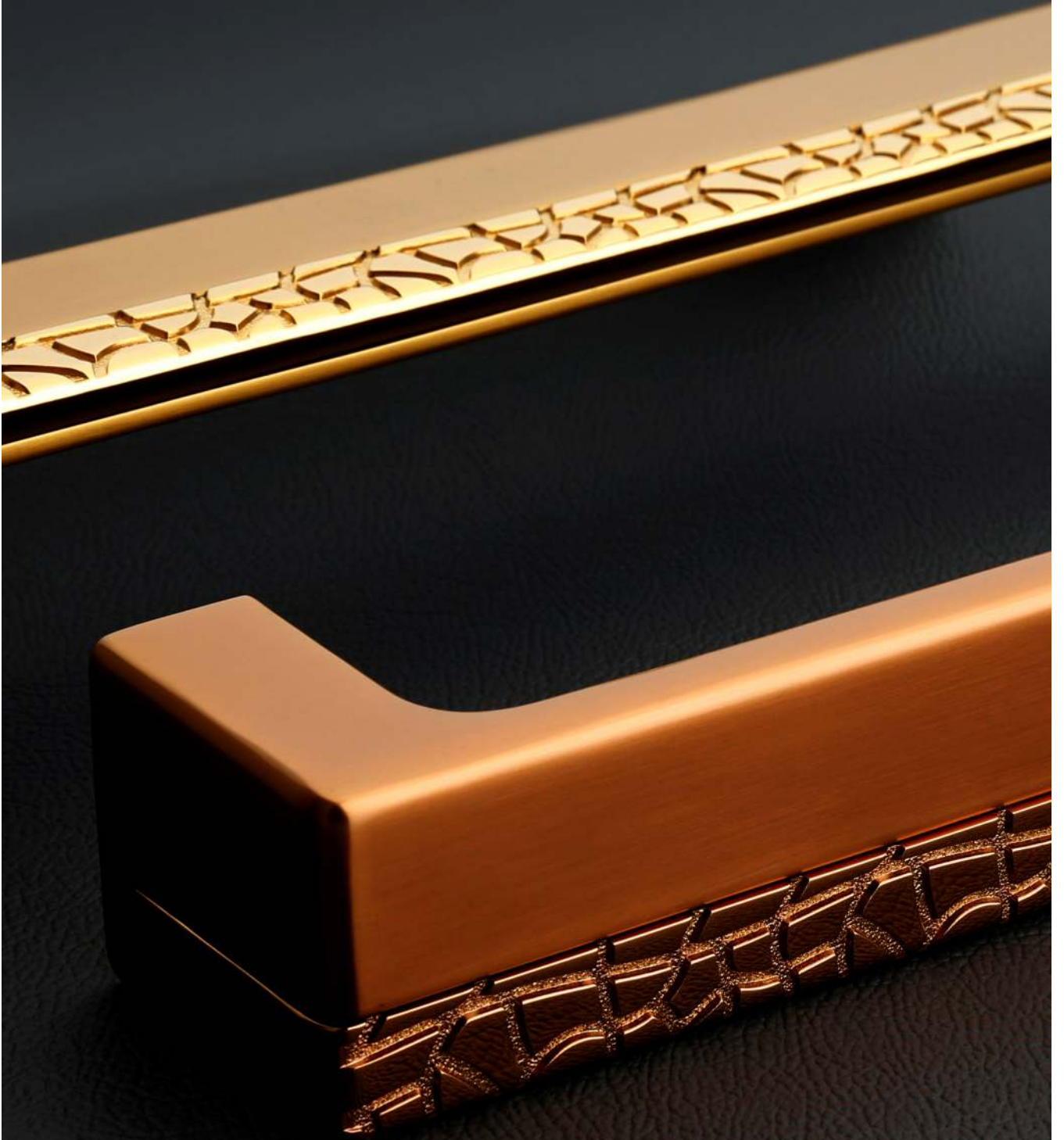

## PULL HANDLES

Clean geometric outlines and stunning plain or textured metal and wood finishes adorn Starrs Pull handles. Drawing inspiration from nature, our intricately crafted styles seamlessly blend in with contemporary interiors without losing their distinctive timeless charm.



Rose Gold



Gold



Black



|                     |                     |      |       |  |
|---------------------|---------------------|------|-------|--|
| <b>PRODUCT CODE</b> | ST-1401             |      |       |  |
| <b>MATERIAL</b>     | Zinc                |      |       |  |
| <b>SIZE C/C</b>     | 200mm, 300mm, 450mm |      |       |  |
| <b>FINISH</b>       | Rose Gold           | Gold | Black |  |



Rose Gold



Gold



Black



|                     |              |      |       |  |
|---------------------|--------------|------|-------|--|
| <b>PRODUCT CODE</b> | ST-1402      |      |       |  |
| <b>MATERIAL</b>     | Zinc         |      |       |  |
| <b>SIZE C/C</b>     | 200mm, 300mm |      |       |  |
| <b>FINISH</b>       | Rose Gold    | Gold | Black |  |



CRG Matt+Black



Black Matt+RG



Satin+CP

|                     |  |               |          |  |
|---------------------|--|---------------|----------|--|
| <b>PRODUCT CODE</b> | ST-1403  |               |          |  |
| <b>MATERIAL</b>     | SS 304   |               |          |  |
| <b>SIZE C/C</b>     | 200mm (22mm Dia), 300mm (22mm Dia), 450mm (25mm Dia) |               |          |  |
| <b>FINISH</b>       | CRG Matt+Black                                       | Black Matt+RG | Satin+CP |  |





CRG Matt+Black

|                     |                     |
|---------------------|---------------------|
| <b>PRODUCT CODE</b> | ST-1404             |
| <b>MATERIAL</b>     | SS 304              |
| <b>SIZE C/C</b>     | 300mm, 450mm, 600mm |
| <b>FINISH</b>       | CRG Matt + Black    |



SS+CP



Black+  
Black-PVD



Matt Antique+  
Antique



Grey+  
Rose Gold-PVD

|                     |  |
|---------------------|--|
| <b>PRODUCT CODE</b> | ST-1405  |
| <b>MATERIAL</b>     | Zinc   |
| <b>SIZE C/C</b>     | 300mm, 450mm   |
| <b>FINISH</b>       | SS+CP    Black+Black-PVD    Matt Antique+Antique    Grey+Rose Gold-PVD |

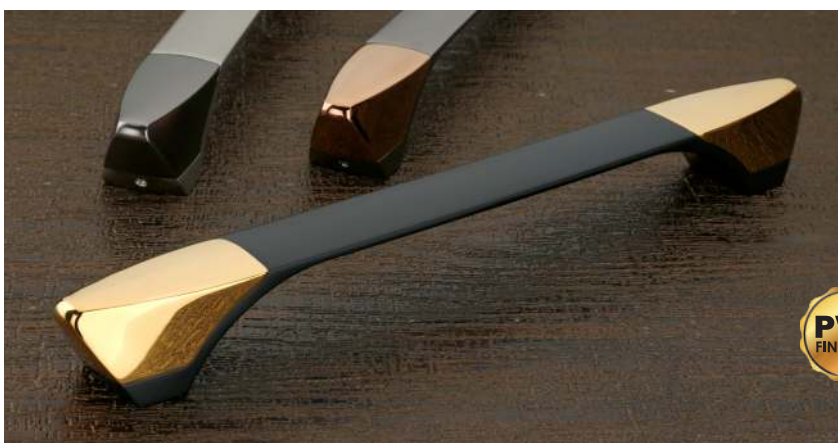

SS+Grey



Grey+  
Rose Gold-PVD



Black+  
Gold-PVD

|                     |   |
|---------------------|---|
| <b>PRODUCT CODE</b> | ST-1406   |
| <b>MATERIAL</b>     | Zinc  |
| <b>SIZE C/C</b>     | 300mm, 450mm                                    |
| <b>FINISH</b>       | SS+Grey    Grey+Rose Gold-PVD    Black+Gold-PVD |





Rose Gold+Black



Antique+Gold



Gold+Black

|                     |                 |              |            |  |
|---------------------|-----------------|--------------|------------|--|
| <b>PRODUCT CODE</b> | ST-1501         |              |            |  |
| <b>MATERIAL</b>     | Zinc            |              |            |  |
| <b>SIZE C/C</b>     | 300mm, 450mm    |              |            |  |
| <b>FINISH</b>       | Rose Gold+Black | Antique+Gold | Gold+Black |  |



Grey Matt+Gloss



RG Matt+Gloss



Antique



Gold Matt+Gloss

|                     |                 |               |         |                 |
|---------------------|-----------------|---------------|---------|-----------------|
| <b>PRODUCT CODE</b> | ST-1502         |               |         |                 |
| <b>MATERIAL</b>     | Zinc            |               |         |                 |
| <b>SIZE C/C</b>     | 300mm, 450mm    |               |         |                 |
| <b>FINISH</b>       | Grey Matt+Gloss | RG Matt+Gloss | Antique | Gold Matt+Gloss |



Antique+Grey



Grey+Rose Gold PVD

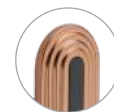

Matt Rose Gold+Black PVD

|                     |              |                    |                          |  |
|---------------------|--------------|--------------------|--------------------------|--|
| <b>PRODUCT CODE</b> | ST-1407      |                    |                          |  |
| <b>MATERIAL</b>     | Zinc         |                    |                          |  |
| <b>SIZE C/C</b>     | 300mm, 450mm |                    |                          |  |
| <b>FINISH</b>       | Antique+Grey | Grey+Rose Gold PVD | Matt Rose Gold+Black PVD |  |



|                     |                   |
|---------------------|-------------------|
| <b>PRODUCT CODE</b> | ST-1304           |
| <b>MATERIAL</b>     | Zinc              |
| <b>SIZE (MM)</b>    | C/C 310 E/E 471   |
| <b>FINISH</b>       | Matt Ant. Brushed |



|                     |                   |
|---------------------|-------------------|
| <b>PRODUCT CODE</b> | ST-1306           |
| <b>MATERIAL</b>     | Zinc              |
| <b>SIZE (MM)</b>    | C/C 500 E/E 560   |
| <b>FINISH</b>       | Matt Ant. Brushed |



|                     |                   |
|---------------------|-------------------|
| <b>PRODUCT CODE</b> | ST-1204           |
| <b>MATERIAL</b>     | Zinc              |
| <b>SIZE C/C</b>     | 200mm, 300mm      |
| <b>FINISH</b>       | SS Matt   Antique |



|                     |                                    |
|---------------------|------------------------------------|
| <b>PRODUCT CODE</b> | ST-1012                            |
| <b>MATERIAL</b>     | Aluminum                           |
| <b>SIZE</b>         | C/C 300 E/E 450<br>C/C 450 E/E 600 |
| <b>FINISH</b>       | Chrome +<br>White Lip Seashell     |



|                     |                                |
|---------------------|--------------------------------|
| <b>PRODUCT CODE</b> | ST-1013                        |
| <b>MATERIAL</b>     | Aluminum                       |
| <b>SIZE</b>         | C/C 300 E/E 450                |
| <b>FINISH</b>       | Chrome +<br>Black Lip Seashell |



|                     |   |
|---------------------|---|
| <b>PRODUCT CODE</b> | ST-1102   |
| <b>MATERIAL</b>     | SS 304  |
| <b>SIZE</b>         | C/C 550 E/E 600<br>C/C 850 E/E 900<br>C/C 1150 E/E 1200 |
| <b>FINISH</b>       | S/S + Mirror Finish                                     |



|                     |                              |
|---------------------|------------------------------|
| <b>PRODUCT CODE</b> | ST-1101                      |
| <b>MATERIAL</b>     | SS 304                       |
| <b>SIZE</b>         | C/C 800 E/E 1000             |
| <b>FINISH</b>       | Ant. Bronze + Green Seashell |



|                     |              |
|---------------------|--------------|
| <b>PRODUCT CODE</b> | ST-1203      |
| <b>MATERIAL</b>     | Zinc         |
| <b>SIZE C/C</b>     | 300mm, 450mm |
| <b>FINISH</b>       | Chrome       |



|                     |                      |
|---------------------|----------------------|
| <b>PRODUCT CODE</b> | ST-909               |
| <b>MATERIAL</b>     | Aluminum             |
| <b>SIZE</b>         | C/C 350 E/E 400      |
| <b>FINISH</b>       | Brushed Satin Nickel |



|                     |                                    |
|---------------------|------------------------------------|
| <b>PRODUCT CODE</b> | ST-910                             |
| <b>MATERIAL</b>     | Aluminum                           |
| <b>SIZE</b>         | C/C 300 E/E 350<br>C/C 350 E/E 400 |
| <b>FINISH</b>       | Brushed Satin Nickel               |



|                     |                                  |
|---------------------|----------------------------------|
| <b>PRODUCT CODE</b> | STML-005                         |
| <b>DESCRIPTION</b>  | Handle with Lock Body & Cylinder |
| <b>MATERIAL</b>     | Zinc                             |
| <b>FINISH</b>       | Satin Nickel                     |



**STARRS**<sup>®</sup>  
Premium Hardware Fitting



## CABINET HANDLES

Everlasting. Reliable. A classic. Basic is the one to turn to when everything else fails. Our values and beliefs are our basics and we believe in "listening to you".



Rose Gold



Antique



SS Matt

|                     |                                  |         |         |  |
|---------------------|----------------------------------|---------|---------|--|
| <b>PRODUCT CODE</b> | EM-101                           |         |         |  |
| <b>MATERIAL</b>     | Zinc                             |         |         |  |
| <b>SIZE C/C</b>     | 96mm, 160mm, 224mm, 288mm, 448mm |         |         |  |
| <b>FINISH</b>       | Rose Gold                        | Antique | SS Matt |  |



SS+CP



Grey+Rose Gold

|                     |                           |                |  |  |
|---------------------|---------------------------|----------------|--|--|
| <b>PRODUCT CODE</b> | EM-102                    |                |  |  |
| <b>MATERIAL</b>     | Zinc                      |                |  |  |
| <b>SIZE C/C</b>     | 96mm, 160mm, 224mm, 288mm |                |  |  |
| <b>FINISH</b>       | SS+CP                     | Grey+Rose Gold |  |  |



Black



Satin

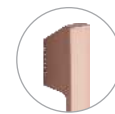

Rose Gold

|                     |                                    |       |           |  |
|---------------------|------------------------------------|-------|-----------|--|
| <b>PRODUCT CODE</b> | EM-201                             |       |           |  |
| <b>MATERIAL</b>     | Aluminum                           |       |           |  |
| <b>SIZE E/E</b>     | 200mm, 500mm, 700mm, 900mm, 1200mm |       |           |  |
| <b>FINISH</b>       | Black                              | Satin | Rose Gold |  |



Chrome



RG PVD



|                     |                           |        |  |  |
|---------------------|---------------------------|--------|--|--|
| <b>PRODUCT CODE</b> | EM-202                    |        |  |  |
| <b>MATERIAL</b>     | Zinc                      |        |  |  |
| <b>SIZE C/C</b>     | 96mm, 160mm, 256mm, 320mm |        |  |  |
| <b>FINISH</b>       | Chrome                    | RG PVD |  |  |



Chrome



SS Matt



Gold PVD

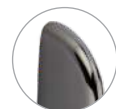

Grey PVD

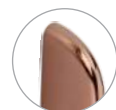

RG PVD

|                     |                           |         |          |          |        |
|---------------------|---------------------------|---------|----------|----------|--------|
| <b>PRODUCT CODE</b> | EM-203                    |         |          |          |        |
| <b>MATERIAL</b>     | Zinc                      |         |          |          |        |
| <b>SIZE C/C</b>     | 96mm, 160mm, 256mm, 320mm |         |          |          |        |
| <b>FINISH</b>       | Chrome                    | SS Matt | Gold PVD | Grey PVD | RG PVD |



Black + RG



Satin + Black



R/G + Black

|                     |   |               |             |  |
|---------------------|---|---------------|-------------|--|
| <b>PRODUCT CODE</b> | EM-204                                    |               |             |  |
| <b>MATERIAL</b>     | Aluminum                                  |               |             |  |
| <b>SIZE (E/E)</b>   | 200mm, 320mm, 500mm, 700mm, 900mm, 1200mm |               |             |  |
| <b>FINISH</b>       | Black + RG                                | Satin + Black | R/G + Black |  |





SS+CP



Antique+Grey



PVD Black+Black



Rose Gold PVD+Wood

|                     |                           |              |                 |                    |
|---------------------|---------------------------|--------------|-----------------|--------------------|
| <b>PRODUCT CODE</b> | EM-205                    |              |                 |                    |
| <b>MATERIAL</b>     | Zinc                      |              |                 |                    |
| <b>SIZE C/C</b>     | 96mm, 160mm, 256mm, 320mm |              |                 |                    |
| <b>FINISH</b>       | SS+CP                     | Antique+Grey | PVD Black+Black | Rose Gold PVD+Wood |



SS+CP



Antique+Grey



Black+Black PVD



Grey+Rose Gold PVD

|                     |                            |              |                 |                    |
|---------------------|----------------------------|--------------|-----------------|--------------------|
| <b>PRODUCT CODE</b> | EM-206                     |              |                 |                    |
| <b>MATERIAL</b>     | Zinc                       |              |                 |                    |
| <b>SIZE C/C</b>     | 128mm, 192mm, 256mm, 320mm |              |                 |                    |
| <b>FINISH</b>       | SS+CP                      | Antique+Grey | Black+Black PVD | Grey+Rose Gold PVD |



Black+Black PVD

|                     |                       |  |  |  |
|---------------------|-----------------------|--|--|--|
| <b>PRODUCT CODE</b> | EM-207 (Left / Right) |  |  |  |
| <b>MATERIAL</b>     | Aluminium+Zinc        |  |  |  |
| <b>SIZE E/E</b>     | 200mm, 500mm, 900mm   |  |  |  |
| <b>FINISH</b>       | Black+Black PVD       |  |  |  |



|                     |                           |
|---------------------|---------------------------|
| <b>PRODUCT CODE</b> | EM-465                    |
| <b>MATERIAL</b>     | Zinc                      |
| <b>SIZE C/C</b>     | 96, 160, 224, 288mm       |
| <b>FINISH</b>       | Chrome, Brushed S. Nickel |



|                     |                                |
|---------------------|--------------------------------|
| <b>PRODUCT CODE</b> | EM-435                         |
| <b>MATERIAL</b>     | Aluminum                       |
| <b>SIZE C/C</b>     | 128, 192, 256, 320, 480, 564mm |
| <b>FINISH</b>       | Chrome                         |



|                     |                      |
|---------------------|----------------------|
| <b>PRODUCT CODE</b> | SR-725               |
| <b>MATERIAL</b>     | Aluminum             |
| <b>SIZE C/C</b>     | 224, 352, 448, 640mm |
| <b>FINISH</b>       | Chrome               |



|                     |                          |
|---------------------|--------------------------|
| <b>PRODUCT CODE</b> | SR-595                   |
| <b>MATERIAL</b>     | Zinc                     |
| <b>SIZE C/C</b>     | 96, 128, 192, 256, 320mm |
| <b>FINISH</b>       | Chrome+Sea Shell         |



|                     |                            |
|---------------------|----------------------------|
| <b>PRODUCT CODE</b> | EM-402                     |
| <b>MATERIAL</b>     | Zinc                       |
| <b>SIZE C/C</b>     | 96, 160, 224, 320mm        |
| <b>FINISH</b>       | Black Brushed with Crystal |



|                     |                     |
|---------------------|---------------------|
| <b>PRODUCT CODE</b> | EM-430              |
| <b>MATERIAL</b>     | Zinc                |
| <b>SIZE C/C</b>     | 96, 160, 224, 320mm |
| <b>FINISH</b>       | Grey Nickel         |

KIDS HANDLES & KNOBS



|                     |       |
|---------------------|-------|
| <b>PRODUCT CODE</b> | H-11  |
| <b>SIZE</b>         | 128mm |



|                     |             |
|---------------------|-------------|
| <b>PRODUCT CODE</b> | H-12        |
| <b>SIZE</b>         | 96mm, 128mm |



|                     |      |
|---------------------|------|
| <b>PRODUCT CODE</b> | K-50 |
|---------------------|------|



|                     |      |
|---------------------|------|
| <b>PRODUCT CODE</b> | K-51 |
|---------------------|------|



|                     |      |
|---------------------|------|
| <b>PRODUCT CODE</b> | K-52 |
|---------------------|------|



|                     |      |
|---------------------|------|
| <b>PRODUCT CODE</b> | K-64 |
|---------------------|------|



|                     |      |
|---------------------|------|
| <b>PRODUCT CODE</b> | K-65 |
|---------------------|------|



## CONCEALED HANDLES

Vintage is here to stay. We love to play with the historical look and antique colours to come with designs that are full of character and create a nice, warm atmosphere.



Satin



Chrome



CRG Gloss

|                     |        |        |           |  |
|---------------------|--------|--------|-----------|--|
| <b>PRODUCT CODE</b> | EM-360 |        |           |  |
| <b>MATERIAL</b>     | Zinc   |        |           |  |
| <b>FINISH</b>       | Satin  | Chrome | CRG Gloss |  |

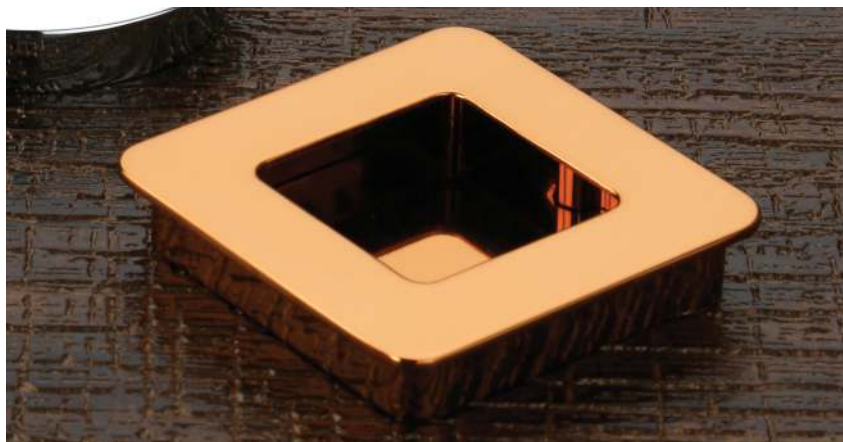

Satin



Chrome



CRG Gloss

|                     |        |        |           |  |
|---------------------|--------|--------|-----------|--|
| <b>PRODUCT CODE</b> | EM-362 |        |           |  |
| <b>MATERIAL</b>     | Zinc   |        |           |  |
| <b>FINISH</b>       | Satin  | Chrome | CRG Gloss |  |



CONCEALED HANDLES



SS Brushed

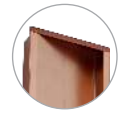

Rose Gold Brushed

|                     |                           |                   |  |
|---------------------|---------------------------|-------------------|--|
| <b>PRODUCT CODE</b> | EM-350                    |                   |  |
| <b>MATERIAL</b>     | Aluminum + Zinc           |                   |  |
| <b>SIZE C/C</b>     | 96mm, 160mm, 224mm, 320mm |                   |  |
| <b>FINISH</b>       | SS Brushed                | Rose Gold Brushed |  |



Black

|                     |                |  |  |
|---------------------|----------------|--|--|
| <b>PRODUCT CODE</b> | EM-355         |  |  |
| <b>MATERIAL</b>     | Aluminium + SS |  |  |
| <b>SIZE C/C</b>     | 160mm, 320mm   |  |  |
| <b>FINISH</b>       | Black          |  |  |



Black

|                     |               |  |  |
|---------------------|---------------|--|--|
| <b>PRODUCT CODE</b> | EM-365        |  |  |
| <b>MATERIAL</b>     | Aluminum + SS |  |  |
| <b>SIZE C/C</b>     | 160mm, 320mm  |  |  |
| <b>FINISH</b>       | Black         |  |  |

CONCEALED HANDLES



SS Matt



Grey Matt



Black+Rose Gold PVD

|                     |                           |           |                     |  |
|---------------------|---------------------------|-----------|---------------------|--|
| <b>PRODUCT CODE</b> | EM-370                    |           |                     |  |
| <b>MATERIAL</b>     | Zinc                      |           |                     |  |
| <b>SIZE C/C</b>     | 96mm, 160mm, 224mm, 288mm |           |                     |  |
| <b>FINISH</b>       | SS Matt                   | Grey Matt | Black+Rose Gold PVD |  |

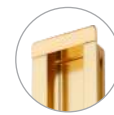

Gold



Black



Rose Gold



SS+CP

|                     |   |       |           |       |
|---------------------|---|-------|-----------|-------|
| <b>PRODUCT CODE</b> | EM-380                                  |       |           |       |
| <b>MATERIAL</b>     | Aluminum + Zinc                         |       |           |       |
| <b>SIZE C/C</b>     | 96mm, 160mm, 224mm, 320mm, 448mm, 700mm |       |           |       |
| <b>FINISH</b>       | Gold                                    | Black | Rose Gold | SS+CP |



SS+CP



Antique+Antique

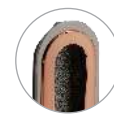

Grey+RG (PVD)



Black+Black (PVD)



|                     |                    |                 |               |                   |
|---------------------|--------------------|-----------------|---------------|-------------------|
| <b>PRODUCT CODE</b> | EM-390             |                 |               |                   |
| <b>MATERIAL</b>     | Zinc               |                 |               |                   |
| <b>SIZE C/C</b>     | 96mm, 160mm, 224mm |                 |               |                   |
| <b>FINISH</b>       | SS+CP              | Antique+Antique | Grey+RG (PVD) | Black+Black (PVD) |



SS+CP



Antique+Antique



Grey+RG PVD



Black+Black PVD



|                     |                           |                 |             |                 |
|---------------------|---------------------------|-----------------|-------------|-----------------|
| <b>PRODUCT CODE</b> | EM-400                    |                 |             |                 |
| <b>MATERIAL</b>     | Zinc                      |                 |             |                 |
| <b>SIZE C/C</b>     | 96mm, 160mm, 224mm, 288mm |                 |             |                 |
| <b>FINISH</b>       | SS+CP                     | Antique+Antique | Grey+RG PVD | Black+Black PVD |



|                      |                        |
|----------------------|------------------------|
| <b>PRODUCT CODE</b>  | EM-306                 |
| <b>MATERIAL</b>      | Aluminum + Zinc        |
| <b>SIZE (MM) C/C</b> | 96, 160, 224, 320, 480 |
| <b>FINISH</b>        | SS Brushed             |



|                      |                             |
|----------------------|-----------------------------|
| <b>PRODUCT CODE</b>  | EM-310                      |
| <b>MATERIAL</b>      | Aluminum + Zinc             |
| <b>SIZE (MM) C/C</b> | 96, 160, 224, 320, 480, 600 |
| <b>FINISH</b>        | AL/SL+Chrome                |



|                     |            |     |
|---------------------|------------|-----|
| <b>PRODUCT CODE</b> | EM-580     |     |
| <b>MATERIAL</b>     | Zinc       |     |
| <b>SIZE C/C</b>     | 64mm, 96mm |     |
| <b>FINISH</b>       | Chrome     | BSN |





## Quintessential Support Framework

**ST★RRS**<sup>®</sup>  
Premium Hardware Fitting

### PROFILES

Safe for all kinds of construction, our metal frames and edges lend the desired strength and stability to structures. Easy-to-use, lightweight and rust-proof, our aluminium profiles have been tested safe for use in extreme weather conditions. Whether you want to build a shelf, crate, swing or greenhouse, there are a plenty of safe and durable profiles to choose from.



**Aster single slide door** profiles are smooth and effortless to operate, better ventilation, energy saving, appealing appearance and easy to maintenance. A compact door system, which is exclusively designed in a modern style with classiness. The design has a perfect combination of premium finishes and glass elegance. This stylish look brings a unique lifestyle in every room. The transparent panel is ensuring the products blends perfectly with the surroundings. The doors are equipped with both side soft close mechanism. These profiles are available in **Matt Black** finish.

**DIAGRAM**

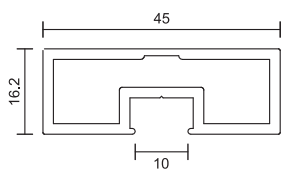
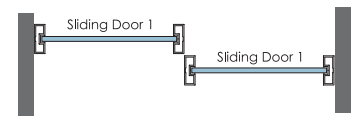

|                     |                             |
|---------------------|-----------------------------|
| <b>PRODUCT NAME</b> | Side Profile                |
| <b>PRODUCT CODE</b> | SASP-01                     |
| <b>DESCRIPTION</b>  | Size : 3 Mtrs (With Gasket) |
| <b>FINISH</b>       | Matt Black                  |

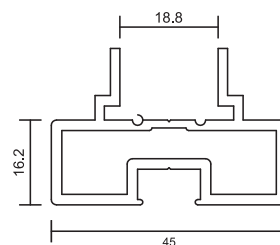

|                     |                            |
|---------------------|----------------------------|
| <b>PRODUCT NAME</b> | Top & Bottom Profile       |
| <b>PRODUCT CODE</b> | SATBP-02                   |
| <b>DESCRIPTION</b>  | Size : 3 Mtr (With Gasket) |
| <b>FINISH</b>       | Matt Black                 |

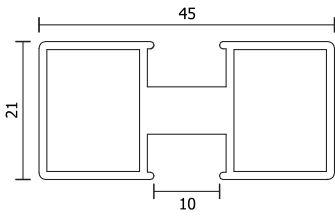

|                     |                 |
|---------------------|-----------------|
| <b>PRODUCT NAME</b> | Divider Profile |
| <b>PRODUCT CODE</b> | SADP-03         |
| <b>DESCRIPTION</b>  | Size : 3 Mtr    |
| <b>FINISH</b>       | Matt Black      |

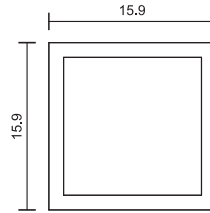

|                     |                 |
|---------------------|-----------------|
| <b>PRODUCT NAME</b> | Divider Profile |
| <b>PRODUCT CODE</b> | SADP-04         |
| <b>DESCRIPTION</b>  | Size : 3 Mtr    |
| <b>FINISH</b>       | Matt Black      |



|                     |                         |
|---------------------|-------------------------|
| <b>PRODUCT NAME</b> | Connector (With screws) |
| <b>PRODUCT CODE</b> | SAPC-07                 |
| <b>MATERIAL</b>     | Zinc                    |



|                     |   |
|---------------------|---|
| <b>PRODUCT NAME</b> | Divider Profile Connector (With screws) |
| <b>PRODUCT CODE</b> | SADPC-08                                |
| <b>MATERIAL</b>     | Aluminium                               |



|                     |                                       |
|---------------------|---------------------------------------|
| <b>PRODUCT CODE</b> | SSR-14                                |
| <b>DESCRIPTION</b>  | Sliding Fitting, Both Side Soft Close |
| <b>WEIGHT CAP.</b>  | 80 Kg.                                |

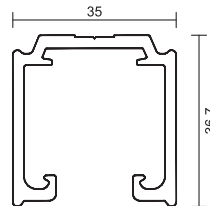

|                     |  |
|---------------------|--|
| <b>PRODUCT CODE</b> | SSC-14                                 |
| <b>DESCRIPTION</b>  | Sliding Channel Size : 3 Mtr, 3.97 Mtr |
| <b>FINISH</b>       | Matt Black                             |

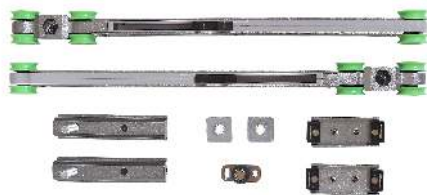

|                     |   |
|---------------------|---|
| <b>PRODUCT CODE</b> | SSR-15                                      |
| <b>DESCRIPTION</b>  | Heavy Sliding Fitting, Both Side Soft Close |
| <b>WEIGHT CAP.</b>  | 120 Kg.                                     |

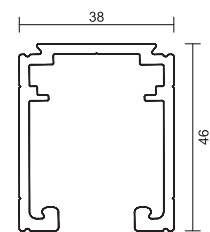

|                     |  |
|---------------------|--|
| <b>PRODUCT CODE</b> | SSC-12                                       |
| <b>DESCRIPTION</b>  | Heavy Sliding Channel Size : 3 Mtr, 3.97 Mtr |
| <b>FINISH</b>       | Matt Black                                   |



|                     |          |
|---------------------|----------|
| <b>PRODUCT NAME</b> | Handle   |
| <b>PRODUCT CODE</b> | SAH-05   |
| <b>MATERIAL</b>     | Aluminum |



|                     |               |
|---------------------|---------------|
| <b>PRODUCT NAME</b> | Handle + Lock |
| <b>PRODUCT CODE</b> | SAHL-06       |
| <b>MATERIAL</b>     | Aluminum      |



|                     |                    |
|---------------------|--------------------|
| <b>PRODUCT NAME</b> | Fixed Door Fitting |
| <b>PRODUCT CODE</b> | SFDF-10            |
| <b>MATERIAL</b>     | SS                 |





This design comes with a **sleek profile** which allows it to occupy minimum space while covering a wide area. Telescopic is an ideal choice for places that do not have a large space. These are very innovative and useful doors provide unusually quite operation. The design has a perfect combination of premium finishes and glass elegance. The doors are equipped with both side soft close mechanism. These profiles are available in **Matt Black** finish.



for installation video please scan barcode

**DIAGRAM**

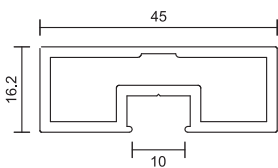
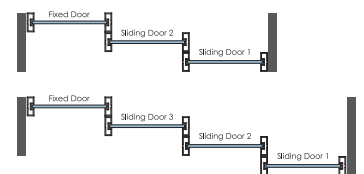

|                     |                             |
|---------------------|-----------------------------|
| <b>PRODUCT NAME</b> | Side Profile                |
| <b>PRODUCT CODE</b> | SASP-01                     |
| <b>DESCRIPTION</b>  | Size : 3 Mtrs (With Gasket) |
| <b>FINISH</b>       | Matt Black                  |

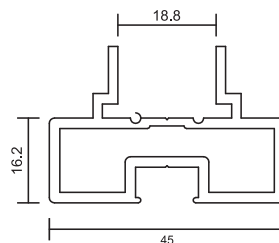

|                     |                            |
|---------------------|----------------------------|
| <b>PRODUCT NAME</b> | Top & Bottom Profile       |
| <b>PRODUCT CODE</b> | SATBP-02                   |
| <b>DESCRIPTION</b>  | Size : 3 Mtr (With Gasket) |
| <b>FINISH</b>       | Matt Black                 |

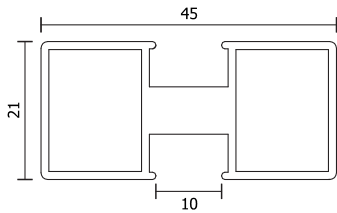

|                     |                 |
|---------------------|-----------------|
| <b>PRODUCT NAME</b> | Divider Profile |
| <b>PRODUCT CODE</b> | SADP-03         |
| <b>DESCRIPTION</b>  | Size : 3 Mtr    |
| <b>FINISH</b>       | Matt Black      |

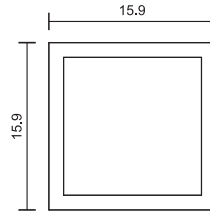

|                     |                 |
|---------------------|-----------------|
| <b>PRODUCT NAME</b> | Divider Profile |
| <b>PRODUCT CODE</b> | SADP-04         |
| <b>DESCRIPTION</b>  | Size : 3 Mtr    |
| <b>FINISH</b>       | Matt Black      |



|                     |           |               |
|---------------------|-----------|---------------|
| <b>PRODUCT NAME</b> | Connector | (With screws) |
| <b>PRODUCT CODE</b> | SAPC-07   |               |
| <b>MATERIAL</b>     | Zinc      |               |



|                     |                           |               |
|---------------------|---------------------------|---------------|
| <b>PRODUCT NAME</b> | Divider Profile Connector | (With screws) |
| <b>PRODUCT CODE</b> | SADPC-08                  |               |
| <b>MATERIAL</b>     | Aluminium                 |               |



|                     |                           |
|---------------------|---------------------------|
| <b>PRODUCT NAME</b> | Telescopic Sliding Roller |
| <b>PRODUCT CODE</b> | SSR-114 (1+2)             |
| <b>PRODUCT CODE</b> | SSR-114 (1+3)             |
| <b>DESCRIPTION</b>  | Both Side Soft Close      |
| <b>WEIGHT CAP.</b>  | 80 Kg.                    |

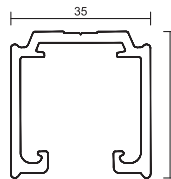

|                     |                 |
|---------------------|-----------------|
| <b>PRODUCT CODE</b> | SSC-14          |
| <b>DESCRIPTION</b>  | Sliding Channel |
| <b>SIZE</b>         | 3 Mtr, 3.97 Mtr |
| <b>FINISH</b>       | Matt Black      |

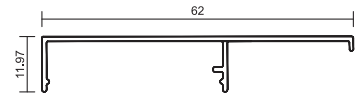

|                     |                |
|---------------------|----------------|
| <b>PRODUCT NAME</b> | Track Cover    |
| <b>PRODUCT CODE</b> | SSTC-14        |
| <b>SIZE</b>         | 3 Mtr, 3.97Mtr |
| <b>FINISH</b>       | Matt Black     |



|                     |                           |
|---------------------|---------------------------|
| <b>PRODUCT NAME</b> | Telescopic Sliding Roller |
| <b>PRODUCT CODE</b> | SSR-115 (1+2)             |
| <b>PRODUCT CODE</b> | SSR-115 (1+3)             |
| <b>DESCRIPTION</b>  | Both Side Soft Close      |
| <b>WEIGHT CAP.</b>  | 120 Kg.                   |

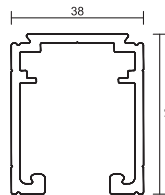

|                     |                    |
|---------------------|--------------------|
| <b>PRODUCT CODE</b> | SSC-12             |
| <b>DESCRIPTION</b>  | Hvy. Slid. Channel |
| <b>SIZE</b>         | 3 Mtr, 3.97 Mtr    |
| <b>FINISH</b>       | Matt Black         |

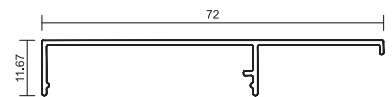

|                     |                |
|---------------------|----------------|
| <b>PRODUCT NAME</b> | Track Cover    |
| <b>PRODUCT CODE</b> | SSTC-12        |
| <b>SIZE</b>         | 3 Mtr, 3.97Mtr |
| <b>FINISH</b>       | Matt Black     |



|                     |          |
|---------------------|----------|
| <b>PRODUCT NAME</b> | Handle   |
| <b>PRODUCT CODE</b> | SAH-05   |
| <b>MATERIAL</b>     | Aluminum |



|                     |               |
|---------------------|---------------|
| <b>PRODUCT NAME</b> | Handle + Lock |
| <b>PRODUCT CODE</b> | SAHL-06       |
| <b>MATERIAL</b>     | Aluminum      |



|                     |                    |
|---------------------|--------------------|
| <b>PRODUCT NAME</b> | Fixed Door Fitting |
| <b>PRODUCT CODE</b> | SFDF-10            |
| <b>MATERIAL</b>     | SS                 |



With the current innovation and specifications of modern sliding door to have synchronized and soft closing feature. One of the most obvious benefits of sliding doors is their space saving properties. The design has a perfect combination of premium finishes and glass elegance. The doors are equipped with both side soft close mechanism. These profiles are available in **Matt Black** finish.



for installation video  
please scan barcode

**DIAGRAM**

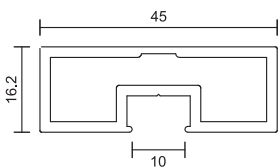
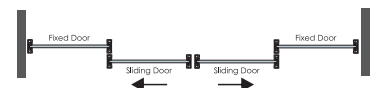

|                     |                             |
|---------------------|-----------------------------|
| <b>PRODUCT NAME</b> | Side Profile                |
| <b>PRODUCT CODE</b> | SASP-01                     |
| <b>DESCRIPTION</b>  | Size : 3 Mtrs (With Gasket) |
| <b>FINISH</b>       | Matt Black                  |

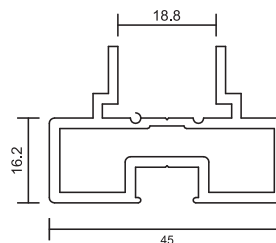

|                     |                            |
|---------------------|----------------------------|
| <b>PRODUCT NAME</b> | Top & Bottom Profile       |
| <b>PRODUCT CODE</b> | SATBP-02                   |
| <b>DESCRIPTION</b>  | Size : 3 Mtr (With Gasket) |
| <b>FINISH</b>       | Matt Black                 |



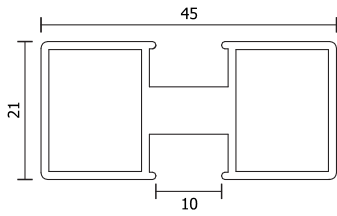

|                     |                 |
|---------------------|-----------------|
| <b>PRODUCT NAME</b> | Divider Profile |
| <b>PRODUCT CODE</b> | SADP-03         |
| <b>DESCRIPTION</b>  | Size : 3 Mtr    |
| <b>FINISH</b>       | Matt Black      |

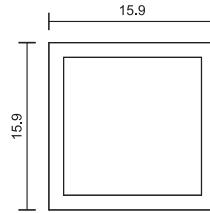

|                     |                 |
|---------------------|-----------------|
| <b>PRODUCT NAME</b> | Divider Profile |
| <b>PRODUCT CODE</b> | SADP-04         |
| <b>DESCRIPTION</b>  | Size : 3 Mtr    |
| <b>FINISH</b>       | Matt Black      |



|                     |           |               |
|---------------------|-----------|---------------|
| <b>PRODUCT NAME</b> | Connector | (With screws) |
| <b>PRODUCT CODE</b> | SAPC-07   |               |
| <b>MATERIAL</b>     | Zinc      |               |



|                     |                           |               |
|---------------------|---------------------------|---------------|
| <b>PRODUCT NAME</b> | Divider Profile Connector | (With screws) |
| <b>PRODUCT CODE</b> | SADPC-08                  |               |
| <b>MATERIAL</b>     | Aluminium                 |               |



|                     |                      |
|---------------------|----------------------|
| <b>PRODUCT NAME</b> | Synchronize Roller   |
| <b>PRODUCT CODE</b> | SSR-214              |
| <b>DESCRIPTION</b>  | Both Side Soft Close |
| <b>WEIGHT CAP.</b>  | 80 Kg.               |

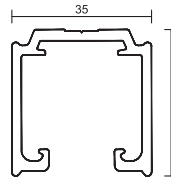

|                     |                 |
|---------------------|-----------------|
| <b>PRODUCT CODE</b> | SSC-14          |
| <b>DESCRIPTION</b>  | Sliding Channel |
| <b>SIZE</b>         | 3 Mtr, 3.97 Mtr |
| <b>FINISH</b>       | Matt Black      |

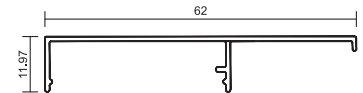

|                     |                |
|---------------------|----------------|
| <b>PRODUCT NAME</b> | Track Cover    |
| <b>PRODUCT CODE</b> | SSTC-14        |
| <b>SIZE</b>         | 3 Mtr, 3.97Mtr |
| <b>FINISH</b>       | Matt Black     |



|                     |                      |
|---------------------|----------------------|
| <b>PRODUCT NAME</b> | Synchronize Roller   |
| <b>PRODUCT CODE</b> | SSR-215              |
| <b>DESCRIPTION</b>  | Both Side Soft Close |
| <b>WEIGHT CAP.</b>  | 120 Kg.              |

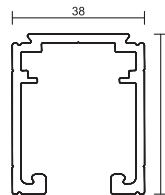

|                     |                    |
|---------------------|--------------------|
| <b>PRODUCT CODE</b> | SSC-12             |
| <b>DESCRIPTION</b>  | Hvy. Slid. Channel |
| <b>SIZE</b>         | 3 Mtr, 3.97 Mtr    |
| <b>FINISH</b>       | Matt Black         |

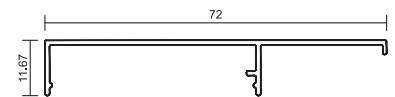

|                     |                |
|---------------------|----------------|
| <b>PRODUCT NAME</b> | Track Cover    |
| <b>PRODUCT CODE</b> | SSTC-12        |
| <b>SIZE</b>         | 3 Mtr, 3.97Mtr |
| <b>FINISH</b>       | Matt Black     |



|                     |          |
|---------------------|----------|
| <b>PRODUCT NAME</b> | Handle   |
| <b>PRODUCT CODE</b> | SAH-05   |
| <b>MATERIAL</b>     | Aluminum |



|                     |               |
|---------------------|---------------|
| <b>PRODUCT NAME</b> | Handle + Lock |
| <b>PRODUCT CODE</b> | SAHL-06       |
| <b>MATERIAL</b>     | Aluminum      |

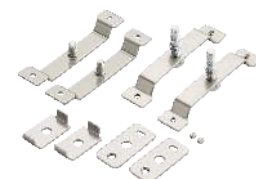

|                     |                    |
|---------------------|--------------------|
| <b>PRODUCT NAME</b> | Fixed Door Fitting |
| <b>PRODUCT CODE</b> | SFDF-10            |
| <b>MATERIAL</b>     | SS                 |



**Ciro** single door sliding is a compact door system, which is exclusively designed in a traditional contemporary aesthetic, which is a fusion between modern and classiness. The design has a perfect combination of premium finishes and glass elegance. This stylish look brings a unique lifestyle in every room. The transparent panel is ensuring the products blends perfectly with the surroundings. The doors are equipped with both side soft close mechanism. These profiles are available in **Matt Black** finish.

**DIAGRAM**

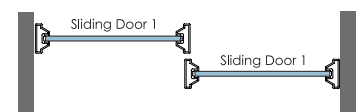

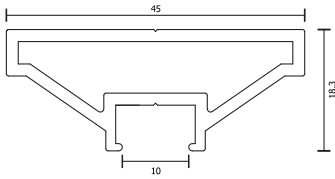

|                     |                             |
|---------------------|-----------------------------|
| <b>PRODUCT NAME</b> | Side Profile                |
| <b>PRODUCT CODE</b> | SCSP-01                     |
| <b>DESCRIPTION</b>  | Size : 3 Mtrs (With Gasket) |
| <b>FINISH</b>       | Matt Black                  |

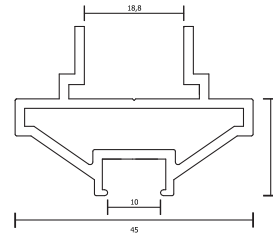

|                     |                            |
|---------------------|----------------------------|
| <b>PRODUCT NAME</b> | Top & Bottom Profile       |
| <b>PRODUCT CODE</b> | SCTBP-02                   |
| <b>DESCRIPTION</b>  | Size : 3 Mtr (With Gasket) |
| <b>FINISH</b>       | Matt Black                 |



|                     |                                       |
|---------------------|---------------------------------------|
| <b>PRODUCT CODE</b> | SSR-14                                |
| <b>DESCRIPTION</b>  | Sliding Fitting, Both Side Soft Close |
| <b>WEIGHT CAP.</b>  | 80 Kg.                                |

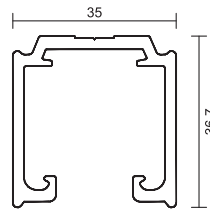

|                     |  |
|---------------------|--|
| <b>PRODUCT CODE</b> | SSC-14                                 |
| <b>DESCRIPTION</b>  | Sliding Channel Size : 3 Mtr, 3.97 Mtr |
| <b>FINISH</b>       | Matt Black                             |

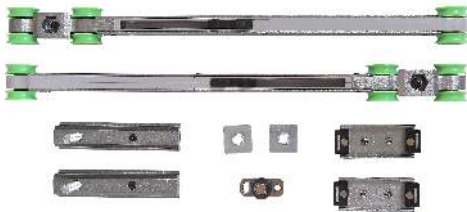

|                     |   |
|---------------------|---|
| <b>PRODUCT CODE</b> | SSR-15                                      |
| <b>DESCRIPTION</b>  | Heavy Sliding Fitting, Both Side Soft Close |
| <b>WEIGHT CAP.</b>  | 120 Kg.                                     |

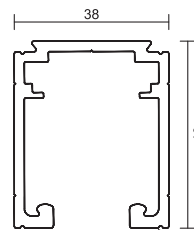

|                     |  |
|---------------------|--|
| <b>PRODUCT CODE</b> | SSC-12                                       |
| <b>DESCRIPTION</b>  | Heavy Sliding Channel Size : 3 Mtr, 3.97 Mtr |
| <b>FINISH</b>       | Matt Black                                   |



|                     |                         |
|---------------------|-------------------------|
| <b>PRODUCT NAME</b> | Connector (With screws) |
| <b>PRODUCT CODE</b> | SCPC-03                 |
| <b>MATERIAL</b>     | Zinc                    |



|                     |                    |
|---------------------|--------------------|
| <b>PRODUCT NAME</b> | Fixed Door Fitting |
| <b>PRODUCT CODE</b> | SFDF-10            |
| <b>MATERIAL</b>     | SS                 |





**Ciro telescopic sliding** is the best choice for limited space and heavy doors. It is made up of leaves that slide one in front of the other to lodge itself into a reduced retraction space on the side when it opens. These doors are ideal for small, partitioned area with little space behind the leaves. The doors are equipped with both side soft close mechanism. These profiles are available in **Matt Black** finish.



for installation video  
please scan barcode

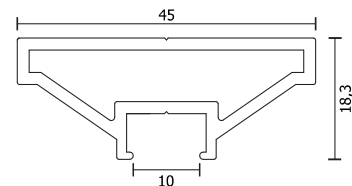

**DIAGRAM**

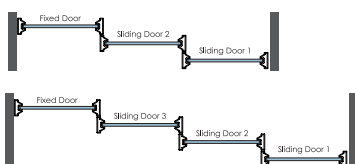

|                     |                             |
|---------------------|-----------------------------|
| <b>PRODUCT NAME</b> | Side Profile                |
| <b>PRODUCT CODE</b> | SCSP-01                     |
| <b>DESCRIPTION</b>  | Size : 3 Mtrs (With Gasket) |
| <b>FINISH</b>       | Matt Black                  |

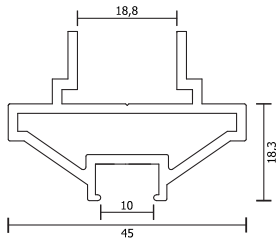

|                     |                            |
|---------------------|----------------------------|
| <b>PRODUCT NAME</b> | Top & Bottom Profile       |
| <b>PRODUCT CODE</b> | SCTBP-02                   |
| <b>DESCRIPTION</b>  | Size : 3 Mtr (With Gasket) |
| <b>FINISH</b>       | Matt Black                 |



|                     |                         |
|---------------------|-------------------------|
| <b>PRODUCT NAME</b> | Connector (With screws) |
| <b>PRODUCT CODE</b> | SCPC-03                 |
| <b>MATERIAL</b>     | Zinc                    |



|                     |                                       |               |
|---------------------|---------------------------------------|---------------|
| <b>PRODUCT NAME</b> | Telescopic Sliding Roller             |               |
| <b>PRODUCT CODE</b> | SSR-114 (1+2)                         | SSR-114 (1+3) |
| <b>DESCRIPTION</b>  | Sliding Fitting, Both Side Soft Close |               |
| <b>WEIGHT CAP.</b>  | 80 Kg.                                |               |



|                     |                                       |               |
|---------------------|---------------------------------------|---------------|
| <b>PRODUCT NAME</b> | Telescopic Sliding Roller             |               |
| <b>PRODUCT CODE</b> | SSR-115 (1+2)                         | SSR-115 (1+3) |
| <b>DESCRIPTION</b>  | Sliding Fitting, Both Side Soft Close |               |
| <b>WEIGHT CAP.</b>  | 120 Kg.                               |               |

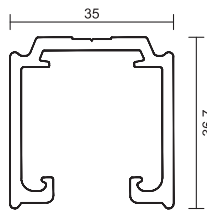

|                     |  |
|---------------------|--|
| <b>PRODUCT CODE</b> | SSC-14                                 |
| <b>DESCRIPTION</b>  | Sliding Channel Size : 3 Mtr, 3.97 Mtr |
| <b>FINISH</b>       | Matt Black                             |

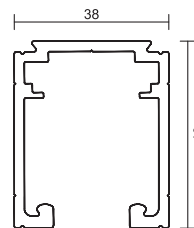

|                     |  |
|---------------------|--|
| <b>PRODUCT CODE</b> | SSC-12                                       |
| <b>DESCRIPTION</b>  | Heavy Sliding Channel Size : 3 Mtr, 3.97 Mtr |
| <b>FINISH</b>       | Matt Black                                   |

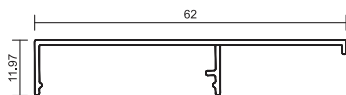

|                     |                |
|---------------------|----------------|
| <b>PRODUCT NAME</b> | Track Cover    |
| <b>PRODUCT CODE</b> | SSTC-14        |
| <b>SIZE</b>         | 3 Mtr, 3.97Mtr |
| <b>FINISH</b>       | Matt Black     |



|                     |                |
|---------------------|----------------|
| <b>PRODUCT NAME</b> | Track Cover    |
| <b>PRODUCT CODE</b> | SSTC-12        |
| <b>SIZE</b>         | 3 Mtr, 3.97Mtr |
| <b>FINISH</b>       | Matt Black     |



|                     |                    |
|---------------------|--------------------|
| <b>PRODUCT NAME</b> | Fixed Door Fitting |
| <b>PRODUCT CODE</b> | SFDF-10            |
| <b>MATERIAL</b>     | SS                 |



With the current innovation and specifications of modern sliding door to have synchronized and soft closing feature. One of the most obvious benefits of sliding doors is their space saving properties. The design has a perfect combination of premium finishes and glass elegance. The doors are equipped with both side soft close mechanism. These profiles are available in **Matt Black** finish.

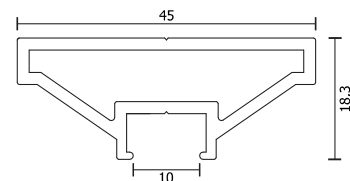

**DIAGRAM**



|                     |                             |
|---------------------|-----------------------------|
| <b>PRODUCT NAME</b> | Side Profile                |
| <b>PRODUCT CODE</b> | SCSP-01                     |
| <b>DESCRIPTION</b>  | Size : 3 Mtrs (With Gasket) |
| <b>FINISH</b>       | Matt Black                  |



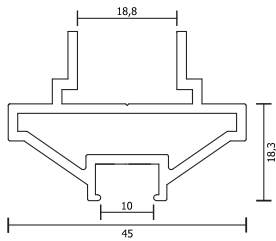

|                     |                            |
|---------------------|----------------------------|
| <b>PRODUCT NAME</b> | Top & Bottom Profile       |
| <b>PRODUCT CODE</b> | SCTBP-02                   |
| <b>DESCRIPTION</b>  | Size : 3 Mtr (With Gasket) |
| <b>FINISH</b>       | Matt Black                 |



|                     |                         |
|---------------------|-------------------------|
| <b>PRODUCT NAME</b> | Connector (With screws) |
| <b>PRODUCT CODE</b> | SCPC-03                 |
| <b>MATERIAL</b>     | Zinc                    |



|                     |                                       |
|---------------------|---------------------------------------|
| <b>PRODUCT NAME</b> | Synchronize Roller                    |
| <b>PRODUCT CODE</b> | SSR-214                               |
| <b>DESCRIPTION</b>  | Sliding Fitting, Both Side Soft Close |
| <b>WEIGHT CAP.</b>  | 80 Kg.                                |



|                     |                                       |
|---------------------|---------------------------------------|
| <b>PRODUCT NAME</b> | Synchronize Roller                    |
| <b>PRODUCT CODE</b> | SSR-215                               |
| <b>DESCRIPTION</b>  | Sliding Fitting, Both Side Soft Close |
| <b>WEIGHT CAP.</b>  | 120 Kg.                               |

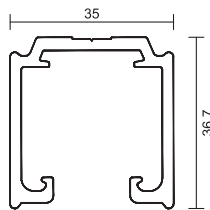

|                     |  |
|---------------------|--|
| <b>PRODUCT CODE</b> | SSC-14                                 |
| <b>DESCRIPTION</b>  | Sliding Channel Size : 3 Mtr, 3.97 Mtr |
| <b>FINISH</b>       | Matt Black                             |

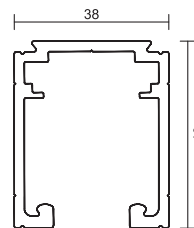

|                     |  |
|---------------------|--|
| <b>PRODUCT CODE</b> | SSC-12                                       |
| <b>DESCRIPTION</b>  | Heavy Sliding Channel Size : 3 Mtr, 3.97 Mtr |
| <b>FINISH</b>       | Matt Black                                   |

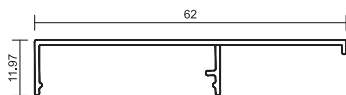

|                     |                |
|---------------------|----------------|
| <b>PRODUCT NAME</b> | Track Cover    |
| <b>PRODUCT CODE</b> | SSTC-14        |
| <b>SIZE</b>         | 3 Mtr, 3.97Mtr |
| <b>FINISH</b>       | Matt Black     |

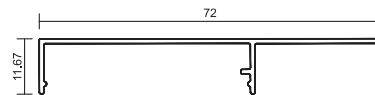

|                     |                |
|---------------------|----------------|
| <b>PRODUCT NAME</b> | Track Cover    |
| <b>PRODUCT CODE</b> | SSTC-12        |
| <b>SIZE</b>         | 3 Mtr, 3.97Mtr |
| <b>FINISH</b>       | Matt Black     |



|                     |                    |
|---------------------|--------------------|
| <b>PRODUCT NAME</b> | Fixed Door Fitting |
| <b>PRODUCT CODE</b> | SFDF-10            |
| <b>MATERIAL</b>     | SS                 |



Innovative and elegant design allow you to make more use of floor space within your home. Every custom- made wardrobes create a varied mixture of high glossed surface transforming into a classic style. Our passion is creating a base for a beautiful and efficient storage.

#### FEATURES

- Doors are equipped with soft close mechanism on both sides.
- Door height is maximum 3mtr.
- This can use 5mm Glass or 10mm Decorative Panels.
- These doors can be moved with complete ease and flexibility
- This mechanism offers higher strength, stiffness and impact resistance made sliding doors run smoother and close softer.



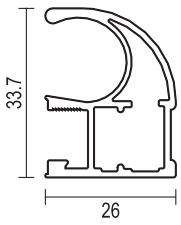

|                     |                       |           |                |
|---------------------|-----------------------|-----------|----------------|
| <b>PRODUCT NAME</b> | Handle Profile        |           |                |
| <b>PRODUCT CODE</b> | SUHP-01               |           |                |
| <b>MATERIAL</b>     | Aluminum              |           |                |
| <b>DESCRIPTION</b>  | Size : 2.5 Mtr, 3 Mtr |           |                |
| <b>FINISH</b>       | Matt Black            | Champagne | Matt Iron Grey |

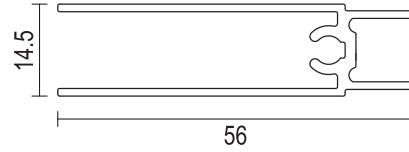

|                     |                |           |                |
|---------------------|----------------|-----------|----------------|
| <b>PRODUCT NAME</b> | Bottom Profile |           |                |
| <b>PRODUCT CODE</b> | SBP-02         |           |                |
| <b>MATERIAL</b>     | Aluminum       |           |                |
| <b>DESCRIPTION</b>  | Size : 3 Mtr   |           |                |
| <b>FINISH</b>       | Matt Black     | Champagne | Matt Iron Grey |

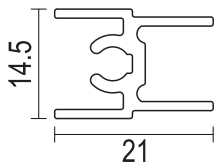

|                     |              |           |                |
|---------------------|--------------|-----------|----------------|
| <b>PRODUCT NAME</b> | Top Profile  |           |                |
| <b>PRODUCT CODE</b> | STP-03       |           |                |
| <b>MATERIAL</b>     | Aluminum     |           |                |
| <b>DESCRIPTION</b>  | Size : 3 Mtr |           |                |
| <b>FINISH</b>       | Matt Black   | Champagne | Matt Iron Grey |

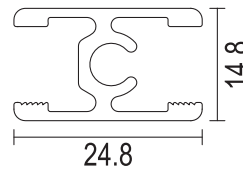

|                     |                 |           |                |
|---------------------|-----------------|-----------|----------------|
| <b>PRODUCT NAME</b> | Divider Profile |           |                |
| <b>PRODUCT CODE</b> | SDP-04          |           |                |
| <b>MATERIAL</b>     | Aluminum        |           |                |
| <b>DESCRIPTION</b>  | Size : 3 Mtr    |           |                |
| <b>FINISH</b>       | Matt Black      | Champagne | Matt Iron Grey |



|                     |                                   |  |  |
|---------------------|-----------------------------------|--|--|
| <b>PRODUCT NAME</b> | Gasket                            |  |  |
| <b>PRODUCT CODE</b> | SGK-05                            |  |  |
| <b>DESCRIPTION</b>  | Size : 15 Mtr (Use for 5mm Glass) |  |  |



|                     |                                 |  |  |
|---------------------|---------------------------------|--|--|
| <b>PRODUCT NAME</b> | Brush Seal                      |  |  |
| <b>PRODUCT CODE</b> | SBS-06                          |  |  |
| <b>DESCRIPTION</b>  | Size : 10 Mtr x 9mm(W) x 8mm(D) |  |  |
| <b>FINISH</b>       | Dark Grey                       |  |  |

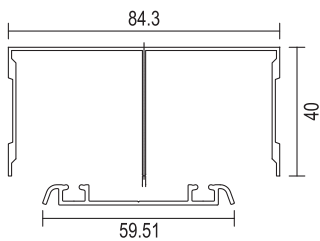

|                     |                                |           |                |
|---------------------|--------------------------------|-----------|----------------|
| <b>PRODUCT CODE</b> | SSC-609                        |           |                |
| <b>DESCRIPTION</b>  | Sliding Channel (Top & Bottom) |           |                |
| <b>SIZE</b>         | 2.5 Mtr, 3.97 Mtr              |           |                |
| <b>FINISH</b>       | Matt Black                     | Champagne | Matt Iron Grey |



|                     |                           |  |  |
|---------------------|---------------------------|--|--|
| <b>PRODUCT CODE</b> | SSR-809                   |  |  |
| <b>DESCRIPTION</b>  | Soft Close Sliding Roller |  |  |
| <b>TYPE</b>         | Both Side Soft Close      |  |  |
| <b>WEIGHT CAP.</b>  | 50 kg (one door)          |  |  |





Sliding wardrobe is a great solution for more confined spaces where the opening door might not be an option. They allow you to maximize your internal storage spaces into everyday lives. This system provides wild possibilities of practical arrangements in home.

**FEATURES**

- Doors are equipped with soft closing mechanism on both sides  
Can use 5mm Glass or 10mm Decorative Panels.
- Door height maximum 3mtr.
- Available with lock option.
- These doors can be moved with complete ease and flexibility
- This mechanism offers higher strength, stiffness and impact resistance made sliding doors run smoother and close softer

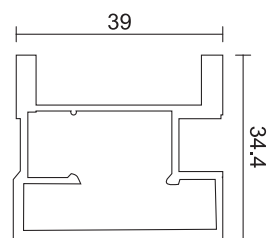

|                     |                       |           |                |
|---------------------|-----------------------|-----------|----------------|
| <b>PRODUCT NAME</b> | Handle Profile        |           |                |
| <b>PRODUCT CODE</b> | SFHP-01               |           |                |
| <b>MATERIAL</b>     | Aluminum              |           |                |
| <b>DESCRIPTION</b>  | Size : 2.5 Mtr, 3 Mtr |           |                |
| <b>FINISH</b>       | Matt Black            | Champagne | Matt Iron Grey |

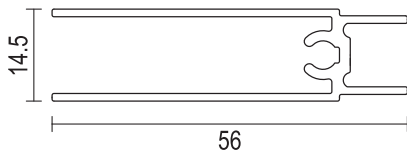

|                     |                |           |                |
|---------------------|----------------|-----------|----------------|
| <b>PRODUCT NAME</b> | Bottom Profile |           |                |
| <b>PRODUCT CODE</b> | SBP-02         |           |                |
| <b>MATERIAL</b>     | Aluminum       |           |                |
| <b>DESCRIPTION</b>  | Size : 3 Mtr   |           |                |
| <b>FINISH</b>       | Matt Black     | Champagne | Matt Iron Grey |

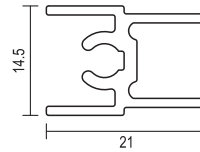

|                     |              |           |                |
|---------------------|--------------|-----------|----------------|
| <b>PRODUCT NAME</b> | Top Profile  |           |                |
| <b>PRODUCT CODE</b> | STP-03       |           |                |
| <b>MATERIAL</b>     | Aluminum     |           |                |
| <b>DESCRIPTION</b>  | Size : 3 Mtr |           |                |
| <b>FINISH</b>       | Matt Black   | Champagne | Matt Iron Grey |

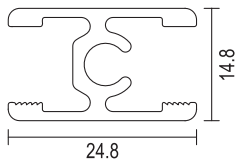

|                     |                 |           |                |
|---------------------|-----------------|-----------|----------------|
| <b>PRODUCT NAME</b> | Divider Profile |           |                |
| <b>PRODUCT CODE</b> | SDP-04          |           |                |
| <b>MATERIAL</b>     | Aluminum        |           |                |
| <b>DESCRIPTION</b>  | Size : 3 Mtr    |           |                |
| <b>FINISH</b>       | Matt Black      | Champagne | Matt Iron Grey |



|                     |                                   |  |  |
|---------------------|-----------------------------------|--|--|
| <b>PRODUCT NAME</b> | Gasket                            |  |  |
| <b>PRODUCT CODE</b> | SGK-05                            |  |  |
| <b>DESCRIPTION</b>  | Size : 15 Mtr (Use for 5mm Glass) |  |  |



|                     |                                 |  |  |
|---------------------|---------------------------------|--|--|
| <b>PRODUCT NAME</b> | Brush Seal                      |  |  |
| <b>PRODUCT CODE</b> | SBS-06                          |  |  |
| <b>DESCRIPTION</b>  | Size : 10 Mtr x 9mm(W) x 8mm(D) |  |  |
| <b>FINISH</b>       | Dark Grey                       |  |  |



|                     |              |  |  |
|---------------------|--------------|--|--|
| <b>PRODUCT NAME</b> | Sliding Lock |  |  |
| <b>PRODUCT CODE</b> | SFSL-07      |  |  |

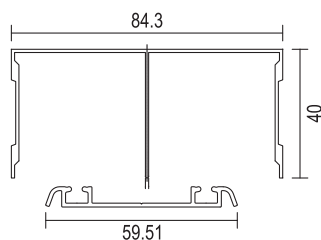

|                     |                                |           |                |
|---------------------|--------------------------------|-----------|----------------|
| <b>PRODUCT CODE</b> | SSC-609                        |           |                |
| <b>DESCRIPTION</b>  | Sliding Channel (Top & Bottom) |           |                |
| <b>SIZE</b>         | 2.5 Mtr, 3.97 Mtr              |           |                |
| <b>FINISH</b>       | Matt Black                     | Champagne | Matt Iron Grey |



|                     |                           |  |  |
|---------------------|---------------------------|--|--|
| <b>PRODUCT CODE</b> | SSR-809                   |  |  |
| <b>DESCRIPTION</b>  | Soft Close Sliding Roller |  |  |
| <b>TYPE</b>         | Both Side Soft Close      |  |  |
| <b>WEIGHT CAP.</b>  | 50 kg (one door)          |  |  |



For long as well as short cabinets and tall units are a must in any house, especially in kitchen and living. Highly versatile & customisable which makes it perfect fit for your living space. Door handles with a curved design that sticks to fundamentals of cabinetry while still emitting a modern vibe. This profile designed naturally initiate groove for the handle which never runs out of fashion. Doors can be fixed with any kind of auto hinges. These profiles are available in **Matt Black** and **Matt Gold Brushed** finishes.



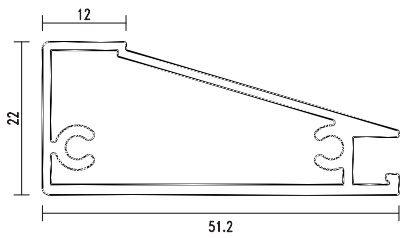

|                     |                  |                   |
|---------------------|------------------|-------------------|
| <b>PRODUCT NAME</b> | Vertical Profile |                   |
| <b>PRODUCT CODE</b> | SCDP-01          |                   |
| <b>MATERIAL</b>     | Aluminum         |                   |
| <b>DESCRIPTION</b>  | Size : 3 Mtr     |                   |
| <b>FINISH</b>       | Matt Black       | Matt Gold Brushed |

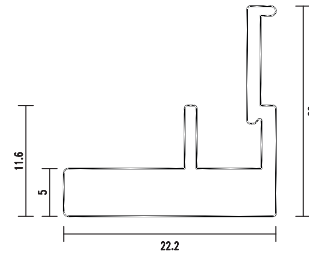

|                     |                      |     |     |                   |     |     |
|---------------------|----------------------|-----|-----|-------------------|-----|-----|
| <b>PRODUCT NAME</b> | Top & Bottom Profile |     |     |                   |     |     |
| <b>PRODUCT CODE</b> | SCDP-02              |     |     |                   |     |     |
| <b>MATERIAL</b>     | Aluminum             |     |     |                   |     |     |
| <b>SIZE (MM)</b>    | 300                  | 350 | 400 | 450               | 500 | 600 |
| <b>FINISH</b>       | Matt Black           |     |     | Matt Gold Brushed |     |     |

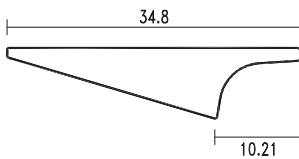

|                     |                           |                   |
|---------------------|---------------------------|-------------------|
| <b>PRODUCT NAME</b> | Curve Door Profile Handle |                   |
| <b>PRODUCT CODE</b> | SCDPH-03                  |                   |
| <b>MATERIAL</b>     | Aluminum                  |                   |
| <b>SIZE (MM)</b>    | 200, 1200                 |                   |
| <b>FINISH</b>       | Matt Black                | Matt Gold Brushed |

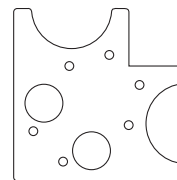

|                     |             |  |
|---------------------|-------------|--|
| <b>PRODUCT NAME</b> | Connector   |  |
| <b>PRODUCT CODE</b> | SCDPC-04    |  |
| <b>DESCRIPTION</b>  | With screws |  |



|                     |                                 |  |
|---------------------|---------------------------------|--|
| <b>PRODUCT NAME</b> | Hinge                           |  |
| <b>PRODUCT CODE</b> | HSC-35                          |  |
| <b>DESCRIPTION</b>  | Soft Close Hinge, 3D Adjustment |  |
| <b>FINISH</b>       | Zinc                            |  |



|                     |                                 |  |
|---------------------|---------------------------------|--|
| <b>PRODUCT NAME</b> | Hinge                           |  |
| <b>PRODUCT CODE</b> | HSC-30                          |  |
| <b>DESCRIPTION</b>  | Soft Close Hinge, 3D Adjustment |  |
| <b>FINISH</b>       | Gun Black                       |  |

**INSTALLATION**

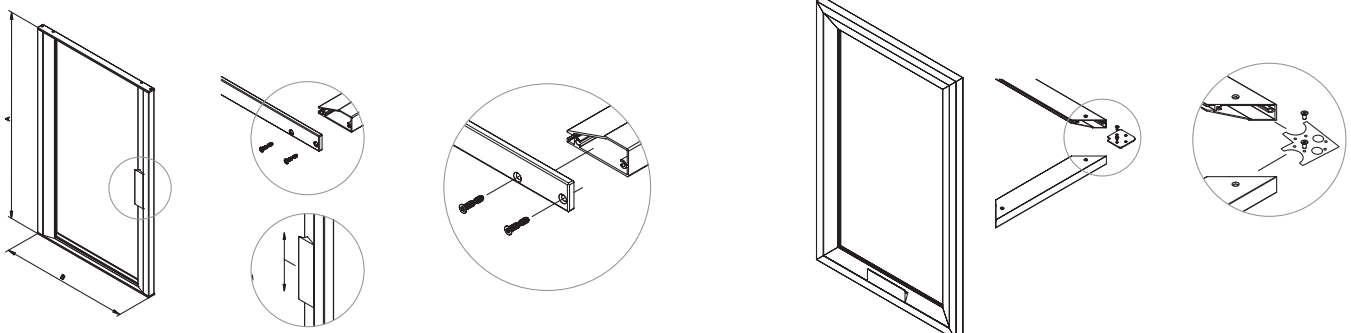



**Slim profile openable wardrobes** designed with aluminium frames with glass allows your wardrobes to be elegant and stylish. The nature, style and state of your wardrobe can impact the whole ambiance of your living room. The right openable wardrobe keeps your room perfect and clean. An openable wardrobe design connected to the wardrobe doors with hinges. One of the advantages of openable wardrobe is the absence of a track as doors are fixed with a door frame. The stylish appearance is another benefit of openable wardrobes.

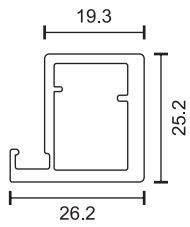

|                     |                                   |
|---------------------|-----------------------------------|
| <b>PRODUCT NAME</b> | Frame Profile                     |
| <b>PRODUCT CODE</b> | SFP-25                            |
| <b>MATERIAL</b>     | Aluminum                          |
| <b>DESCRIPTION</b>  | Width : 25mm Size : 3 Mtr.        |
| <b>FINISH</b>       | Matt Black      Matt Gold Brushed |

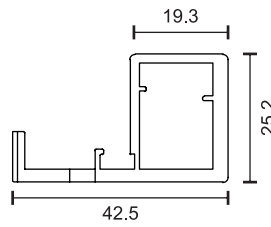

|                     |                                   |
|---------------------|-----------------------------------|
| <b>PRODUCT NAME</b> | Handle Frame Profile              |
| <b>PRODUCT CODE</b> | SHFP-25                           |
| <b>MATERIAL</b>     | Aluminum                          |
| <b>DESCRIPTION</b>  | Use with SFP-25 Size : 3 Mtr.     |
| <b>FINISH</b>       | Matt Black      Matt Gold Brushed |

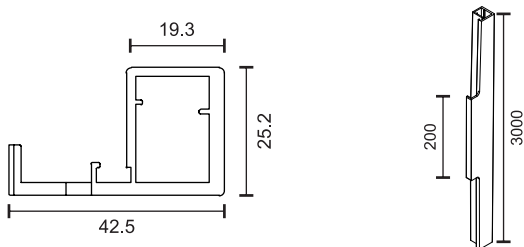

|                     |                                   |
|---------------------|-----------------------------------|
| <b>PRODUCT NAME</b> | Handle Frame Profile              |
| <b>PRODUCT CODE</b> | SHFP-26                           |
| <b>MATERIAL</b>     | Aluminum                          |
| <b>DESCRIPTION</b>  | Use with SFP-25 Size : 3 Mtr.     |
| <b>FINISH</b>       | Matt Black      Matt Gold Brushed |



|                     |                                   |
|---------------------|-----------------------------------|
| <b>PRODUCT CODE</b> | SFH-27                            |
| <b>MATERIAL</b>     | Aluminum                          |
| <b>DESCRIPTION</b>  | (Use with SFP-25)                 |
| <b>FINISH</b>       | Matt Black      Matt Gold Brushed |



|                     |                                |
|---------------------|--------------------------------|
| <b>PRODUCT NAME</b> | Air Concealed Soft Close Hinge |
| <b>DESCRIPTION</b>  | One set 2 Pcs (R & L)          |
| <b>WEIGHT CAP.</b>  | 20 kg.                         |



|                     |  |
|---------------------|--|
| <b>PRODUCT NAME</b> | Air Hinge Connector                      |
| <b>DESCRIPTION</b>  | Use for SFP-25, SHFP-25, SHFP-26 Profile |



|                     |                                  |
|---------------------|----------------------------------|
| <b>PRODUCT CODE</b> | HSC-26                           |
| <b>PRODUCT NAME</b> | Soft Close Hinges, 3D Adjustment |
| <b>DESCRIPTION</b>  | Use for (25mm) Aluminium Profile |



**Wardrobe Aluminum Pipe**

|                     |             |               |  |
|---------------------|-------------|---------------|--|
| <b>PRODUCT CODE</b> | SAP-01      |               |  |
| <b>MATERIAL</b>     | Aluminum    |               |  |
| <b>DESCRIPTION</b>  | With Gasket | Size : 3 Mtr. |  |
| <b>FINISH</b>       | Matt Black  |               |  |

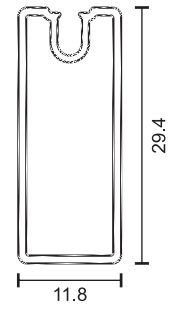

**Edge Handle Profile**

|                     |                 |                |  |
|---------------------|-----------------|----------------|--|
| <b>PRODUCT CODE</b> | SEP-08          |                |  |
| <b>MATERIAL</b>     | Aluminum        |                |  |
| <b>DESCRIPTION</b>  | Size : 2.5 Mtr. |                |  |
| <b>FINISH</b>       | Matt Black      | Matt Rose Gold |  |

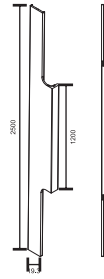

**Edge Handle Profile**

|                     |              |                 |                   |
|---------------------|--------------|-----------------|-------------------|
| <b>PRODUCT CODE</b> | SEP-09       |                 |                   |
| <b>MATERIAL</b>     | Aluminum     |                 |                   |
| <b>DESCRIPTION</b>  | Left / Right | Size : 2.7 Mtr. |                   |
| <b>FINISH</b>       | Matt Black   | Champagne       | Matt Gold Brushed |

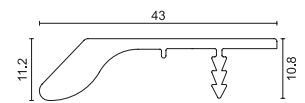
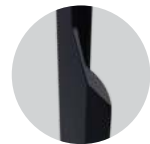
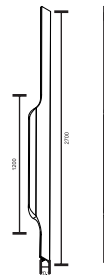

### Shutter Divider Profile

|                     |   |           |           |  |
|---------------------|---|-----------|-----------|--|
| <b>PRODUCT CODE</b> | Divider Profile   |           |           |  |
| <b>MATERIAL</b>     | Aluminum  |           |           |  |
| <b>DESCRIPTION</b>  | Front View 18.5mm Size : 3 Mtr. (use with SFP-45 & SHFP-45) |           |           |  |
| <b>FINISH</b>       | Matt Black  | Champagne | Iron Grey |  |

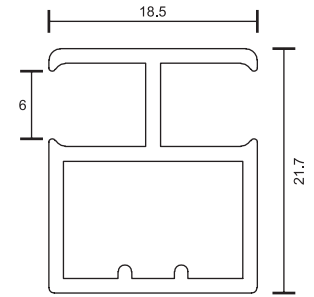

### J-End Cap Profile

|                     |                                      |           |  |  |
|---------------------|--------------------------------------|-----------|--|--|
| <b>PRODUCT CODE</b> | SEJP-38                              |           |  |  |
| <b>MATERIAL</b>     | Aluminum                             |           |  |  |
| <b>DESCRIPTION</b>  | Use for Wooden Shutter Size : 3 Mtr. |           |  |  |
| <b>FINISH</b>       | Matt Black                           | Champagne |  |  |

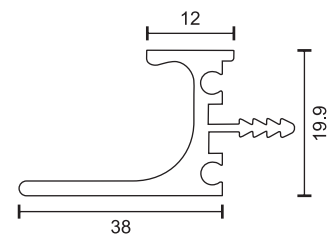



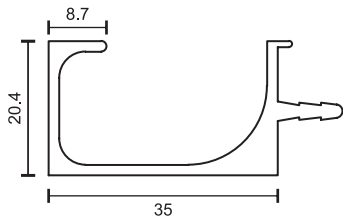

**G-Profile**

|                     |                            |        |           |           |       |            |                |                   |
|---------------------|----------------------------|--------|-----------|-----------|-------|------------|----------------|-------------------|
| <b>PRODUCT CODE</b> | SGP-35                     |        |           |           |       |            |                |                   |
| <b>MATERIAL</b>     | Aluminum                   |        |           |           |       |            |                |                   |
| <b>DESCRIPTION</b>  | Width : 35mm Size : 3 Mtr. |        |           |           |       |            |                |                   |
| <b>FINISH</b>       | Aluminum                   | Mirror | Champagne | Iron Grey | Satin | Matt Black | Matt Rose Gold | Gold              |
|                     |                            |        |           |           |       |            |                | Matt Gold Brushed |

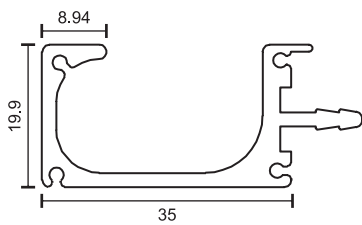

**G-End Cap Profile**

|                     |                            |        |           |           |       |            |                |  |
|---------------------|----------------------------|--------|-----------|-----------|-------|------------|----------------|--|
| <b>PRODUCT CODE</b> | SGEP-35                    |        |           |           |       |            |                |  |
| <b>MATERIAL</b>     | Aluminum                   |        |           |           |       |            |                |  |
| <b>DESCRIPTION</b>  | Width : 35mm Size : 3 Mtr. |        |           |           |       |            |                |  |
| <b>FINISH</b>       | Aluminum                   | Mirror | Champagne | Iron Grey | Satin | Matt Black | Matt Rose Gold |  |

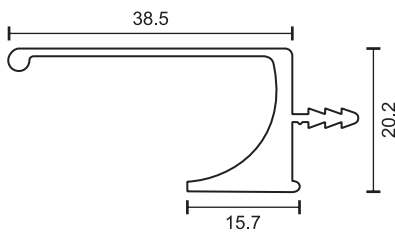

**J-Profile**

|                     |                              |           |           |  |  |  |  |  |
|---------------------|------------------------------|-----------|-----------|--|--|--|--|--|
| <b>PRODUCT CODE</b> | J-Profile                    |           |           |  |  |  |  |  |
| <b>MATERIAL</b>     | Aluminum                     |           |           |  |  |  |  |  |
| <b>DESCRIPTION</b>  | Width : 38.5mm Size : 3 Mtr. |           |           |  |  |  |  |  |
| <b>FINISH</b>       | Mirror                       | Champagne | Iron Grey |  |  |  |  |  |

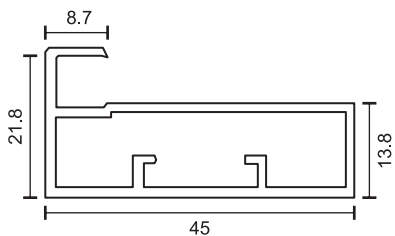

**Frame Profile**

|                     |   |        |           |           |       |            |                |                   |
|---------------------|---|--------|-----------|-----------|-------|------------|----------------|-------------------|
| <b>PRODUCT CODE</b> | SFP-45  |        |           |           |       |            |                |                   |
| <b>MATERIAL</b>     | Aluminum                                      |        |           |           |       |            |                |                   |
| <b>DESCRIPTION</b>  | Width 45mm, Inclusive of Gasket Size : 3 Mtr. |        |           |           |       |            |                |                   |
| <b>FINISH</b>       | Aluminum                                      | Mirror | Champagne | Iron Grey | Satin | Matt Black | Matt Rose Gold | Gold              |
|                     |   |        |           |           |       |            |                | Matt Gold Brushed |

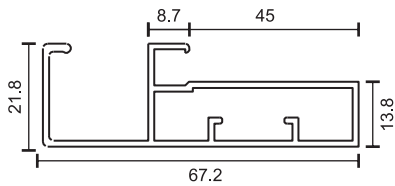

### Handle Frame Profile

|                     |   |        |           |           |       |            |                   |
|---------------------|---|--------|-----------|-----------|-------|------------|-------------------|
| <b>PRODUCT CODE</b> | SHFP-45   |        |           |           |       |            |                   |
| <b>MATERIAL</b>     | Aluminum  |        |           |           |       |            |                   |
| <b>DESCRIPTION</b>  | Width 67.2mm, Inclusive of Gasket (Use with SFP-45) Size : 3 Mtr. |        |           |           |       |            |                   |
| <b>FINISH</b>       | Aluminum  | Mirror | Champagne | Iron Grey | Satin | Matt Black | Matt Rose Gold    |
|                     |   |        |           |           |       |            | Matt Gold Brushed |

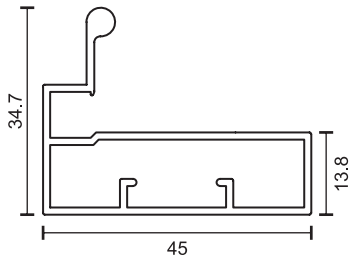

### Handle Frame Profile

|                     |   |           |            |      |  |  |  |
|---------------------|---|-----------|------------|------|--|--|--|
| <b>PRODUCT CODE</b> | SHFP-65   |           |            |      |  |  |  |
| <b>MATERIAL</b>     | Aluminum  |           |            |      |  |  |  |
| <b>DESCRIPTION</b>  | Width 45mm, Inclusive of Gasket (Use with SFP-45) Size : 3 Mtr. |           |            |      |  |  |  |
| <b>FINISH</b>       | Champagne   | Iron Grey | Matt Black | Gold |  |  |  |

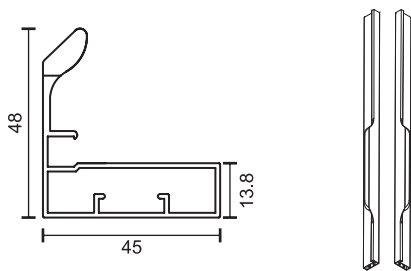

### Handle Frame Profile

|                     |   |            |  |  |  |  |  |
|---------------------|---|------------|--|--|--|--|--|
| <b>PRODUCT CODE</b> | SHFP-75   |            |  |  |  |  |  |
| <b>MATERIAL</b>     | Aluminum  |            |  |  |  |  |  |
| <b>DESCRIPTION</b>  | Left / Right, Inclusive of Gasket (Use with SFP-45) Size : 3 Mtr. |            |  |  |  |  |  |
| <b>FINISH</b>       | Matt Gold Brushed   | Matt Black |  |  |  |  |  |

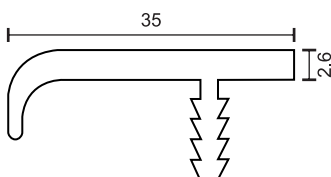

### Edge Handle Profile

|                     |                             |        |           |           |      |  |  |
|---------------------|-----------------------------|--------|-----------|-----------|------|--|--|
| <b>PRODUCT CODE</b> | SP-021                      |        |           |           |      |  |  |
| <b>MATERIAL</b>     | Aluminum                    |        |           |           |      |  |  |
| <b>DESCRIPTION</b>  | Width : 35mm, Size : 3 Mtr. |        |           |           |      |  |  |
| <b>FINISH</b>       | Aluminum                    | Mirror | Champagne | Iron Grey | Gold |  |  |

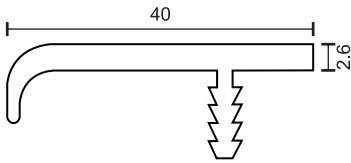

**Edge Handle Profile**

|                     |                             |         |  |  |  |  |  |  |
|---------------------|-----------------------------|---------|--|--|--|--|--|--|
| <b>PRODUCT CODE</b> | SP-040                      |         |  |  |  |  |  |  |
| <b>MATERIAL</b>     | Aluminum                    |         |  |  |  |  |  |  |
| <b>DESCRIPTION</b>  | Width : 40mm, Size : 3 Mtr. |         |  |  |  |  |  |  |
| <b>FINISH</b>       | Satin                       | Antique |  |  |  |  |  |  |

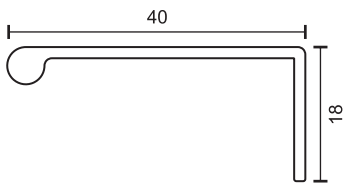

**Edge Handle Profile**

|                     |               |           |  |  |  |  |  |  |
|---------------------|---------------|-----------|--|--|--|--|--|--|
| <b>PRODUCT CODE</b> | SP-025        |           |  |  |  |  |  |  |
| <b>MATERIAL</b>     | Aluminum      |           |  |  |  |  |  |  |
| <b>DESCRIPTION</b>  | Size : 3 Mtr. |           |  |  |  |  |  |  |
| <b>FINISH</b>       | Champagne     | Iron Grey |  |  |  |  |  |  |

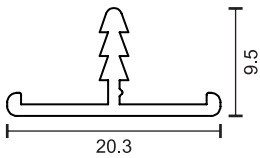

**T-Profile**

|                     |               |           |  |  |  |  |  |  |
|---------------------|---------------|-----------|--|--|--|--|--|--|
| <b>PRODUCT CODE</b> | STP-20        |           |  |  |  |  |  |  |
| <b>MATERIAL</b>     | Aluminum      |           |  |  |  |  |  |  |
| <b>DESCRIPTION</b>  | Size : 3 Mtr. |           |  |  |  |  |  |  |
| <b>FINISH</b>       | Champagne     | Iron Grey |  |  |  |  |  |  |

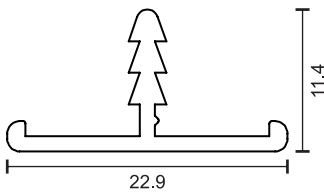

**T-Profile**

|                     |               |        |           |           |       |                 |                |      |
|---------------------|---------------|--------|-----------|-----------|-------|-----------------|----------------|------|
| <b>PRODUCT CODE</b> | STP-22        |        |           |           |       |                 |                |      |
| <b>MATERIAL</b>     | Aluminum      |        |           |           |       |                 |                |      |
| <b>DESCRIPTION</b>  | Size : 3 Mtr. |        |           |           |       |                 |                |      |
| <b>FINISH</b>       | Aluminum      | Mirror | Champagne | Iron Grey | Satin | Anthracite Grey | Antique        |      |
|                     |               |        |           |           |       | Matt Black      | Matt Rose Gold | Gold |



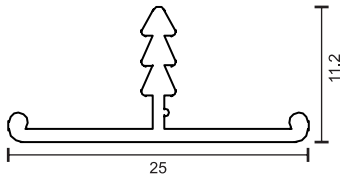

### T-Profile

|                     |               |        |           |           |            |                |  |
|---------------------|---------------|--------|-----------|-----------|------------|----------------|--|
| <b>PRODUCT CODE</b> | STP-25        |        |           |           |            |                |  |
| <b>MATERIAL</b>     | Aluminum      |        |           |           |            |                |  |
| <b>DESCRIPTION</b>  | Size : 3 Mtr. |        |           |           |            |                |  |
| <b>FINISH</b>       | Aluminum      | Mirror | Champagne | Iron Grey | Matt Black | Matt Rose Gold |  |

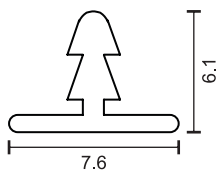

### Inlay

|                     |                   |           |            |      |  |  |  |
|---------------------|-------------------|-----------|------------|------|--|--|--|
| <b>PRODUCT CODE</b> | INLAY 8MM         |           |            |      |  |  |  |
| <b>MATERIAL</b>     | Aluminum          |           |            |      |  |  |  |
| <b>DESCRIPTION</b>  | 8mm Size : 3 Mtr. |           |            |      |  |  |  |
| <b>FINISH</b>       | Champagne         | Iron Grey | Matt Black | Gold |  |  |  |

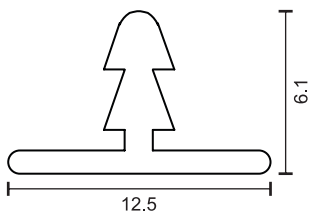

### Inlay

|                     |                    |           |            |      |  |  |  |
|---------------------|--------------------|-----------|------------|------|--|--|--|
| <b>PRODUCT CODE</b> | INLAY 12MM         |           |            |      |  |  |  |
| <b>MATERIAL</b>     | Aluminum           |           |            |      |  |  |  |
| <b>DESCRIPTION</b>  | 12mm Size : 3 Mtr. |           |            |      |  |  |  |
| <b>FINISH</b>       | Champagne          | Iron Grey | Matt Black | Gold |  |  |  |

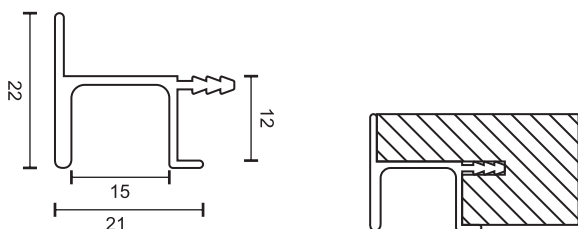

### Edge Handle Profile

|                     |  |            |           |  |  |  |  |
|---------------------|--|------------|-----------|--|--|--|--|
| <b>PRODUCT CODE</b> | SEP-10                                       |            |           |  |  |  |  |
| <b>MATERIAL</b>     | Aluminum                                     |            |           |  |  |  |  |
| <b>DESCRIPTION</b>  | Size : 2.7 Mtr., Use for wooden sliding door |            |           |  |  |  |  |
| <b>FINISH</b>       | Champagne                                    | Matt Black | Iron Grey |  |  |  |  |

### J-Gola Profile

|                     |  |           |           |                |
|---------------------|--|-----------|-----------|----------------|
| <b>PRODUCT CODE</b> | J-Gola Profile                                     |           |           |                |
| <b>MATERIAL</b>     | Aluminum   |           |           |                |
| <b>DESCRIPTION</b>  | Use for Handle Less Doors & Shutters Size : 3 Mtr. |           |           |                |
| <b>FINISH</b>       | Matt Black   | Champagne | Iron Grey | Matt Rose Gold |

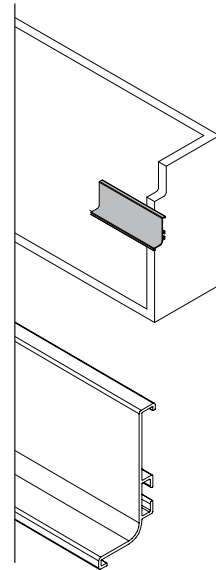
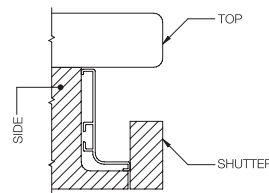
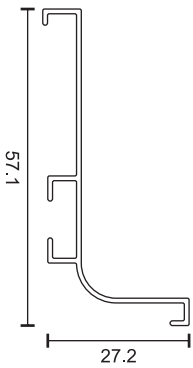

### C-Gola Profile

|                     |  |           |           |                |
|---------------------|--|-----------|-----------|----------------|
| <b>PRODUCT CODE</b> | C-Gola Profile                                     |           |           |                |
| <b>MATERIAL</b>     | Aluminum   |           |           |                |
| <b>DESCRIPTION</b>  | Use for Handle Less Doors & Shutters Size : 3 Mtr. |           |           |                |
| <b>FINISH</b>       | Matt Black   | Champagne | Iron Grey | Matt Rose Gold |

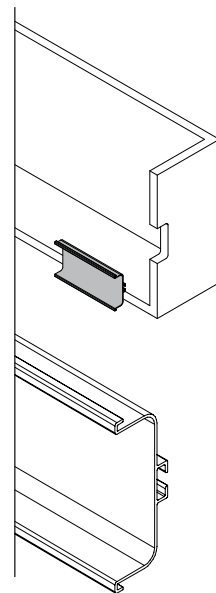
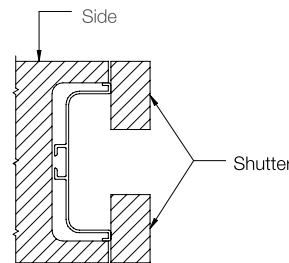
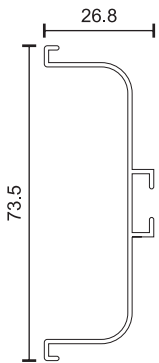

### Overhead Cabinet Profile

|                     |  |           |           |                |
|---------------------|--|-----------|-----------|----------------|
| <b>PRODUCT CODE</b> | Overhead Cabinet Profile   |           |           |                |
| <b>MATERIAL</b>     | Aluminum   |           |           |                |
| <b>DESCRIPTION</b>  | Use for Handle Less Doors & Shutters (Inclusive of Gasket) Size : 3 Mtr. |           |           |                |
| <b>FINISH</b>       | Matt Black   | Champagne | Iron Grey | Matt Rose Gold |

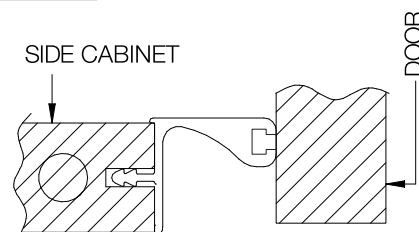
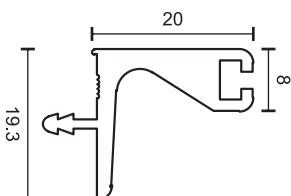





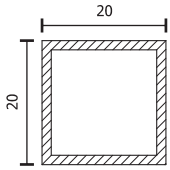

|                     |                                |
|---------------------|--------------------------------|
| <b>PRODUCT NAME</b> | Lateral Profile                |
| <b>PRODUCT CODE</b> | SMSPL-01                       |
| <b>MATERIAL</b>     | Aluminum                       |
| <b>DESCRIPTION</b>  | Size : 3 Mtr.                  |
| <b>FINISH</b>       | Matt Black   Matt Gold Brushed |

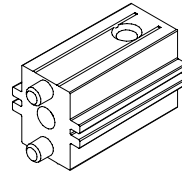

|                     |  |
|---------------------|--|
| <b>PRODUCT NAME</b> | Connector  |
| <b>PRODUCT CODE</b> | SMSPC-05   |
| <b>MATERIAL</b>     | Zinc   |
| <b>DESCRIPTION</b>  | Use with SMSPL-01, SMSPU-02, SMSPU-03, SMSPV-04 (with Screw) |

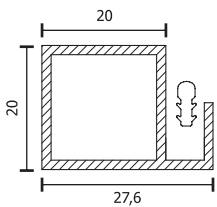

|                     |   |
|---------------------|---|
| <b>PRODUCT NAME</b> | Universal Profile                                       |
| <b>PRODUCT CODE</b> | SMSPU-02  |
| <b>MATERIAL</b>     | Aluminum  |
| <b>DESCRIPTION</b>  | Size : 3 Mtr. inclusive of gasket (Use for glass shelf) |
| <b>FINISH</b>       | Matt Black   Matt Gold Brushed                          |

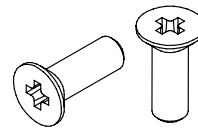

|                     |                        |
|---------------------|------------------------|
| <b>PRODUCT NAME</b> | Screw                  |
| <b>PRODUCT CODE</b> | SMSPS-06               |
| <b>MATERIAL</b>     | S/S                    |
| <b>DESCRIPTION</b>  | 4 x 10mm               |
| <b>FINISH</b>       | Matt Black   Matt Gold |

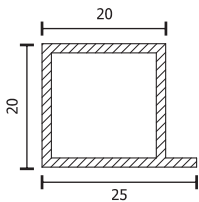

|                     |                                      |
|---------------------|--------------------------------------|
| <b>PRODUCT NAME</b> | Universal Profile                    |
| <b>PRODUCT CODE</b> | SMSPU-03                             |
| <b>MATERIAL</b>     | Aluminum                             |
| <b>DESCRIPTION</b>  | Size : 3 Mtr. (Use for wooden shelf) |
| <b>FINISH</b>       | Matt Black   Matt Gold Brushed       |

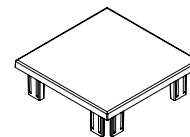

|                     |                        |
|---------------------|------------------------|
| <b>PRODUCT NAME</b> | PVC End Cap            |
| <b>PRODUCT CODE</b> | SMSPEC-07              |
| <b>MATERIAL</b>     | PVC                    |
| <b>DESCRIPTION</b>  | Use with SMSPV-04      |
| <b>FINISH</b>       | Matt Black   Matt Gold |

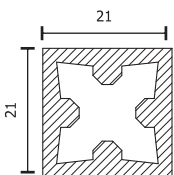

|                     |                                |
|---------------------|--------------------------------|
| <b>PRODUCT NAME</b> | Vertical Profile               |
| <b>PRODUCT CODE</b> | SMSPV-04                       |
| <b>MATERIAL</b>     | Aluminum                       |
| <b>DESCRIPTION</b>  | Size : 3 Mtr.                  |
| <b>FINISH</b>       | Matt Black   Matt Gold Brushed |

**FEATURES :**

- Smart Modular Shelving Profile is an innovative shelving system which is flexible, modern and customizable as per your design.
- Shelving aluminium profile can be installed hassle free without putting much effort into it.
- These profiles and their accessories enable construction of open shelves with glass or wood with their sleek and faultless built and finish.
- It is available in **Matt Black & Matt Gold Brushed** finish.
- The application can be used in a multi way as a bookshelf on a wall, decorative shelf in the kitchen for crockery, etc.

**INSTALLATION**

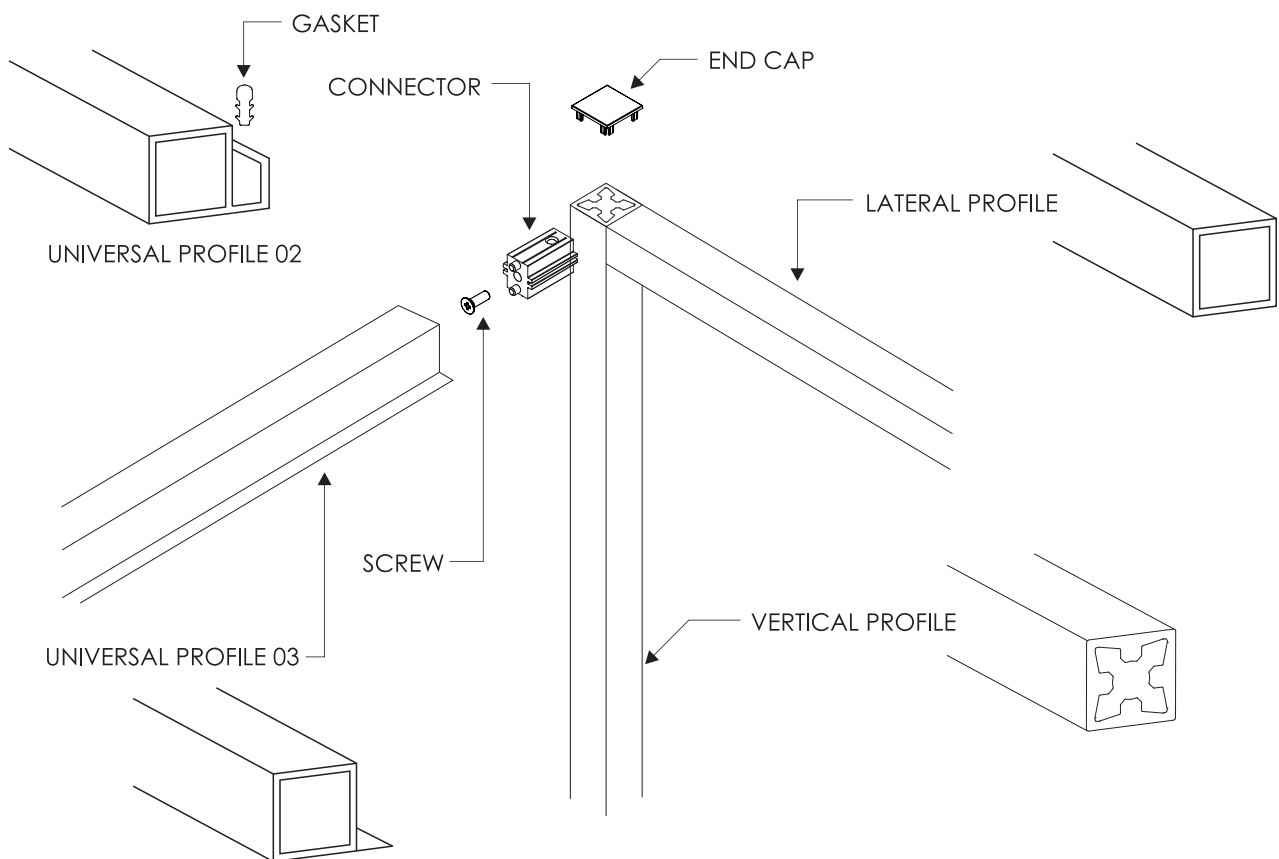



### L-Connector

|                    |  |
|--------------------|--|
| <b>DESCRIPTION</b> | (Use for SFP-45 Profile, SHFP-45 Profile)<br>Big size with screw |
|--------------------|--|



### Air Hinge Connector

|                    |  |
|--------------------|--|
| <b>DESCRIPTION</b> | Use for SFP-25, SHFP-25,<br>SHFP-26 Profiles |
|--------------------|--|



### Gola Profile Connector

|                    |  |
|--------------------|--|
| <b>DESCRIPTION</b> | Use for J-Gola Profile, C-Gola Profile<br>(with screw) |
|--------------------|--|



### Zinc End Cap

|                    |                      |
|--------------------|----------------------|
| <b>DESCRIPTION</b> | Use for SGEP Profile |
| <b>FINISH</b>      | CP                   |



### Centre Support

|                    |                |
|--------------------|----------------|
| <b>DESCRIPTION</b> | Use for SAP-01 |
| <b>FINISH</b>      | Matt Black     |



### PVC End Cap

|                    |                      |           |         |
|--------------------|----------------------|-----------|---------|
| <b>DESCRIPTION</b> | Use for SGEP Profile |           |         |
| <b>FINISH</b>      | Anodized             | Rose Gold | Grey    |
|                    | Chrome               | Satin     | Antique |
|                    |                      |           | Black   |



### J-End Cap

|                    |                         |                |
|--------------------|-------------------------|----------------|
| <b>MATERIAL</b>    | Zinc                    |                |
| <b>DESCRIPTION</b> | Use for SEJP-38 Profile |                |
| <b>FINISH</b>      | Matt Black              | Matt Rose Gold |



### Divider Profile Connector

|                    |                                      |
|--------------------|--------------------------------------|
| <b>DESCRIPTION</b> | (Use for Divider Profile) with Screw |
| <b>MATERIAL</b>    | Aluminum                             |



### Pipe Bracket

|                     |                  |
|---------------------|------------------|
| <b>PRODUCT CODE</b> | SAPB-01          |
| <b>DESCRIPTION</b>  | (Use for SAP-01) |
| <b>MATERIAL</b>     | Aluminum         |
| <b>FINISH</b>       | Matt Black       |



DECORATIVE  
**U,L&T**  
CHANNEL



**ST★RRS**<sup>®</sup>  
Premium Hardware Fitting





### U-Type Channel

|                  |   |          |  |  |
|------------------|---|----------|--|--|
| <b>MATERIAL</b>  | S.S. 304  |          |  |  |
| <b>LENGTH</b>    | 2.5 Mtr. Edge : 90° V-Cut                             |          |  |  |
| <b>SIZE (MM)</b> | 10 x 5 x 10, 10 x 10 x 10, 10 x 20 x 10, 10 x 40 x 10 |          |  |  |
| <b>FINISH</b>    | Rose Gold PVD   | Gold PVD |  |  |

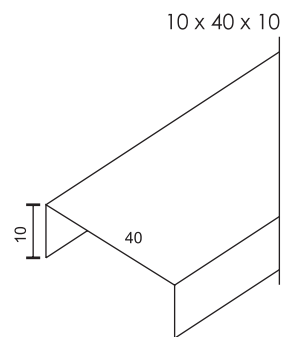
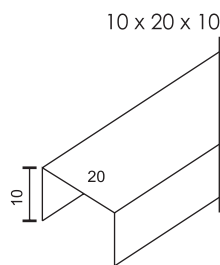
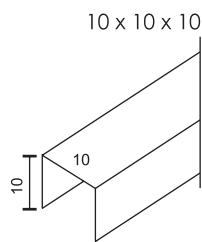
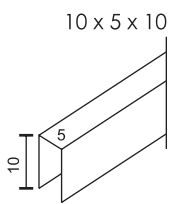

### T-Type Channel

|                  |                           |          |  |  |
|------------------|---------------------------|----------|--|--|
| <b>MATERIAL</b>  | S.S. 304                  |          |  |  |
| <b>LENGTH</b>    | 2.5 Mtr. Edge : 90° V-Cut |          |  |  |
| <b>SIZE (MM)</b> | 8mm, 12mm, 19mm           |          |  |  |
| <b>FINISH</b>    | Rose Gold PVD             | Gold PVD |  |  |

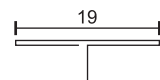
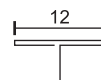

### L-Type Channel

|                  |                           |          |  |  |
|------------------|---------------------------|----------|--|--|
| <b>MATERIAL</b>  | S.S. 304                  |          |  |  |
| <b>LENGTH</b>    | 2.5 Mtr. Edge : 90° V-Cut |          |  |  |
| <b>SIZE (MM)</b> | 20mm x 20mm               |          |  |  |
| <b>FINISH</b>    | Rose Gold PVD             | Gold PVD |  |  |

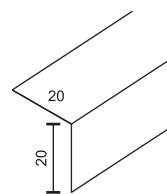





**STARRS**<sup>®</sup>  
Premium Hardware Fitting

FURNITURE  
LIGHTING



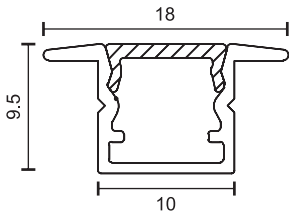

**LED Profile-01**

|                    |                       |
|--------------------|-----------------------|
| <b>DESCRIPTION</b> | Profile with Diffuser |
| <b>SIZE</b>        | 18mm x 9.5mm x 3Mtr.  |
| <b>FINISH</b>      | Aluminium Matt        |

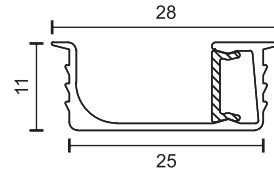

**LED Profile-05**

|                    |                       |
|--------------------|-----------------------|
| <b>DESCRIPTION</b> | Profile with Diffuser |
| <b>SIZE</b>        | 28mm x 11mm x 3 Mtr.  |
| <b>FINISH</b>      | Aluminium Matt        |

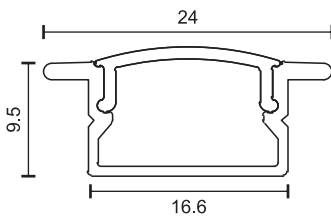

**LED Profile-02**

|                    |                       |
|--------------------|-----------------------|
| <b>DESCRIPTION</b> | Profile with Diffuser |
| <b>SIZE</b>        | 24mm x 9.5mm x 3 Mtr. |
| <b>FINISH</b>      | Aluminium Matt        |

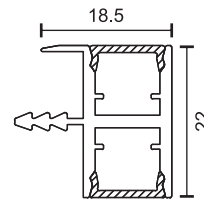

**LED Profile-06**

|                    |                        |
|--------------------|------------------------|
| <b>DESCRIPTION</b> | Profile with Diffuser  |
| <b>SIZE</b>        | 18.5mm x 22mm x 3 Mtr. |
| <b>FINISH</b>      | Aluminium Matt         |

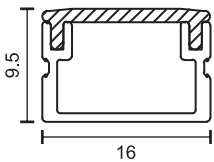

**LED Profile-03**

|                    |                       |
|--------------------|-----------------------|
| <b>DESCRIPTION</b> | Profile with Diffuser |
| <b>SIZE</b>        | 16mm x 9.5mm x 3 Mtr. |
| <b>FINISH</b>      | Aluminium Matt        |



**Switch**

|               |       |
|---------------|-------|
| <b>FINISH</b> | White |
|---------------|-------|

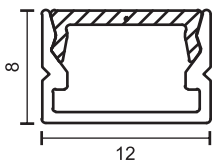

**LED Profile-04**

|                    |                       |
|--------------------|-----------------------|
| <b>DESCRIPTION</b> | Profile with Diffuser |
| <b>SIZE</b>        | 12mm x 8mm x 3 Mtr.   |
| <b>FINISH</b>      | Aluminium Matt        |



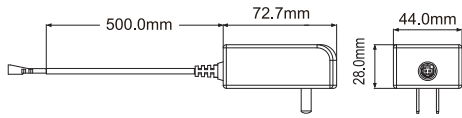

INPUT : 100 - 240V    OUTPUT : 12V

**Plug**

**SIZE** 1.5mtr Cable (EU-Type)

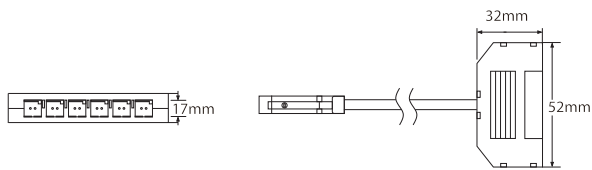

DC : 12V

**Distributor**

**SIZE** 0.2mtr Cable

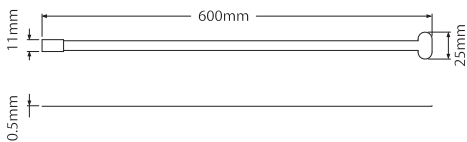

**Membrane Switch**

**SIZE** 2mtr Cable

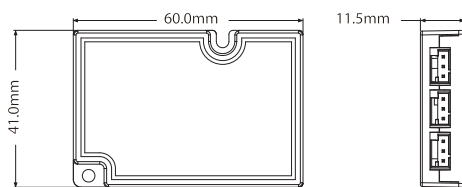

INPUT : DC12V    OUTPUT : DC12V

**Membrane Controller**

**SIZE** 0.2mtr Cable



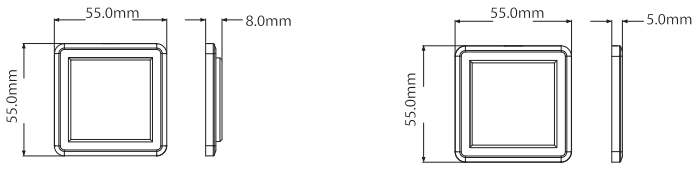

**INPUT :** DC12V **POWER :** 2.3W

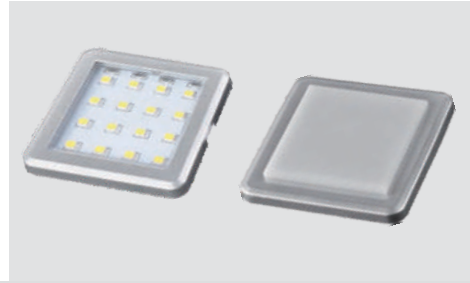

**Light-01**

|                    |              |
|--------------------|--------------|
| <b>DESCRIPTION</b> | Square       |
| <b>SIZE</b>        | 2 mtr. Cable |
| <b>COLOUR</b>      | Milky White  |

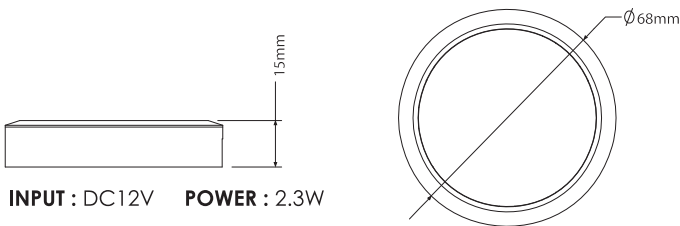

**INPUT :** DC12V **POWER :** 2.3W

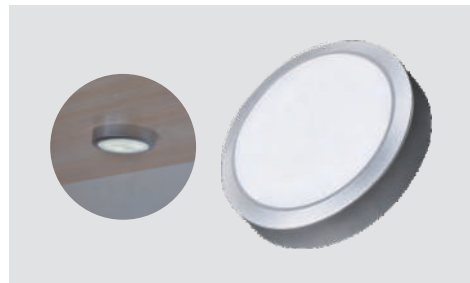

**Light-02**

|                    |              |
|--------------------|--------------|
| <b>DESCRIPTION</b> | Round        |
| <b>SIZE</b>        | 2 mtr. Cable |
| <b>COLOUR</b>      | Milky White  |

**LED Driver**

|             |                          |
|-------------|--------------------------|
| <b>SIZE</b> | 1.5 mtr. Cable (EU Type) |
|-------------|--------------------------|

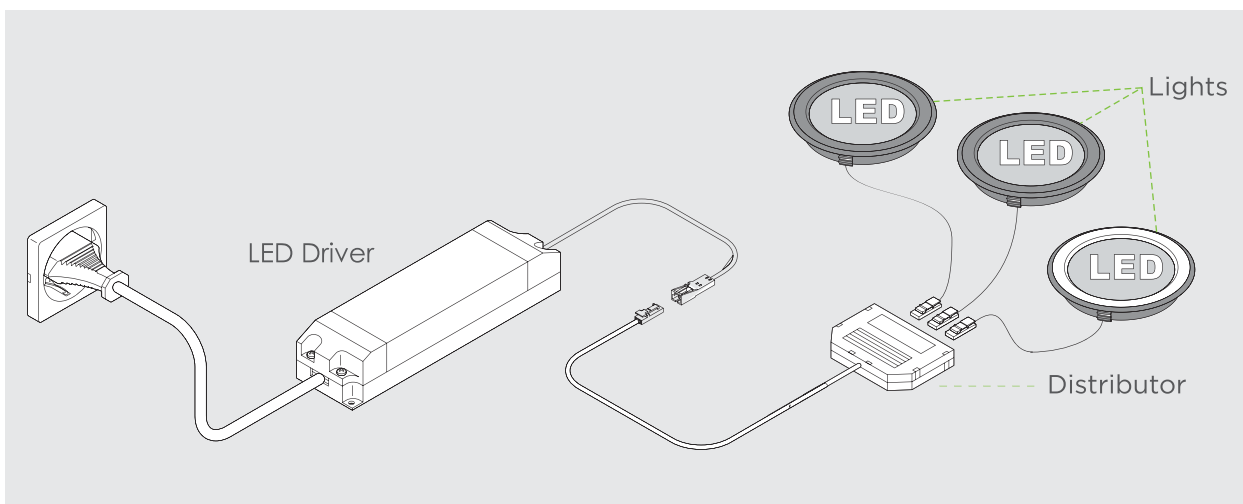



**SWL-15KG**

|                    |                            |
|--------------------|----------------------------|
| <b>DESCRIPTION</b> | Soft Close Wardrobe Lifter |
| <b>SIZE</b>        | 710mm - 1160mm             |
| <b>CAPACITY</b>    | 15kg.                      |



**SWF-05**

|                    |                             |
|--------------------|-----------------------------|
| <b>DESCRIPTION</b> | Top Mounted Rotating Hanger |
| <b>FINISH</b>      | White+Chrome                |

# HIGH END KITCHEN STORAGE

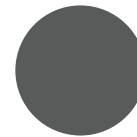
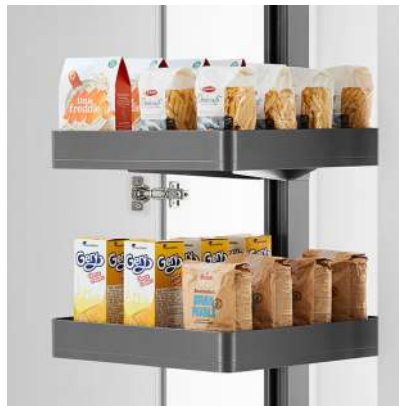

## High-class Grey

Extremely low-key,  
but everywhere revealed  
the benefits of the high-level sense.

## PURPLE CRYSTAL SERIES & ENCANTO SERIES

### Function

German Technology, super load-bearing Damping, fully pull-out guide rail, simple and brand new linkage structure, pull out the inner baskets while opening the door. Load-bearing point of cabinet door focus on bottom of cabinet, protect the door from deformation.

### Design

Slim sides design, interpreting minimalism and light luxury style, enhance the taste of kitchen storage. The bottom is covered by non-slip mat, prevent the items from collision, and convenient to clean at the same time.

### Quality

Sides of basket is made of superior aviation aluminium alloy, advanced fluorocarbon coating surface treatment technology, strong, rust resistance, abrasive resistance. The linkage structure is made of premium steel, European standard environmental surface treatment technology, running smooth and stable.

### Storage

It is recommended to store frequently-used kitchen utensils, shakes, dried fruit or condiments, It is suitable to be used with embedded refrigerator in high cabinet combination, not only can convenient to fetch items, but also can reduce the abrupt feeling of single use.





HIGH END KITCHEN STORAGE  
PURPLE CRYSTAL

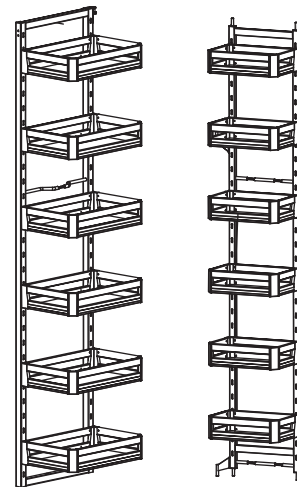
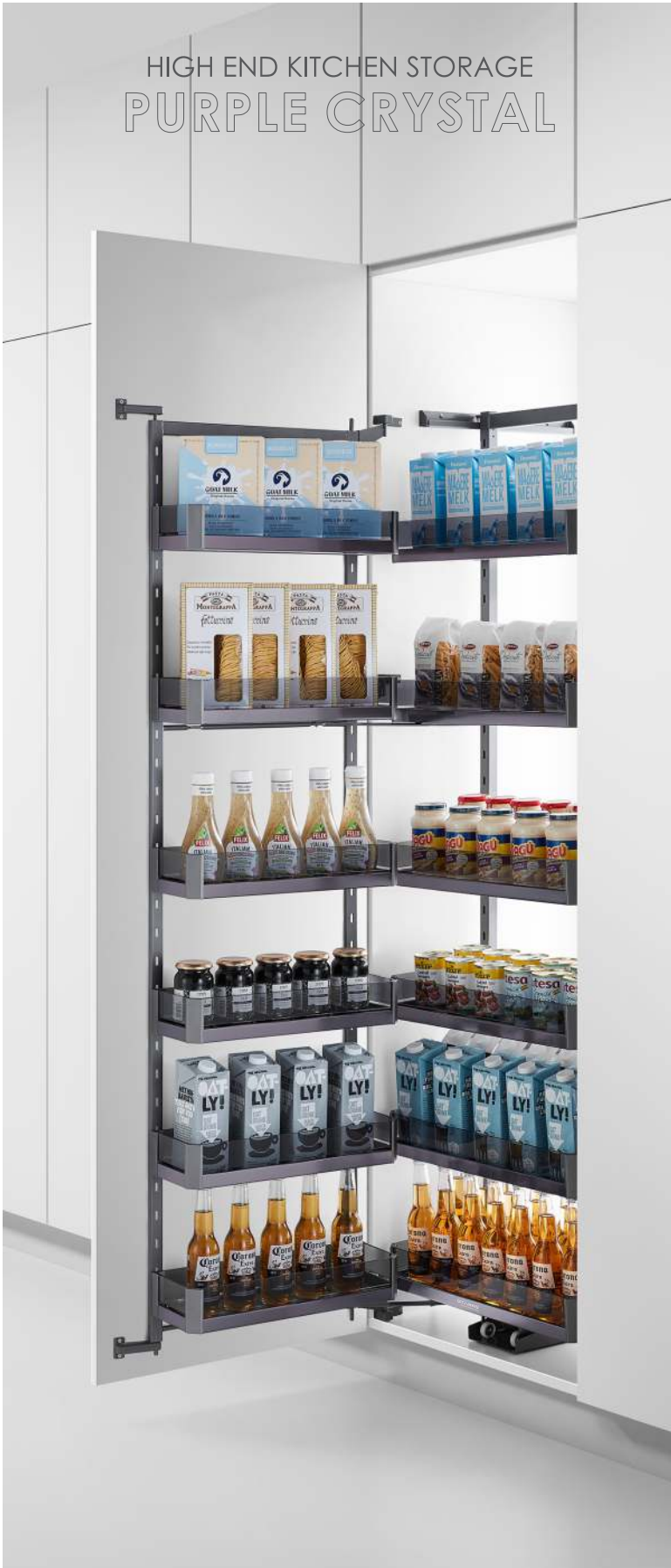

Basket is made of alloy  
(chromed purple)  
and tempered glass

**Loading Capacity**

Max Loading for each bigger  
Basket 5kg, Max Loading  
for each smaller Basket 3kg.

Slim side design, interpreting minimalism  
and light luxury style, enhance the taste  
of kitchen storage. The bottom is covered  
by non-slip mat, prevent the items from  
collision, and convenient to clean at the  
same time.



**PANTRY ROLL OUT**

| PRODUCT CODE  | SPECIFICATION (W x D x H) | CARCASE SIZE | DESCRIPTION | FINISH             | TYPE       |
|---------------|---------------------------|--------------|-------------|--------------------|------------|
| PCPRO - 70712 | 405 x 500 x 1780mm        | 450mm        | 6 Basket    | Upgrade Grey Glass | Soft Close |
| PCPRO - 70713 | 555 x 500 x 1780mm        | 600mm        | 6 Basket    | Upgrade Grey Glass | Soft Close |

HIGH END KITCHEN STORAGE  
**PURPLE CRYSTAL**

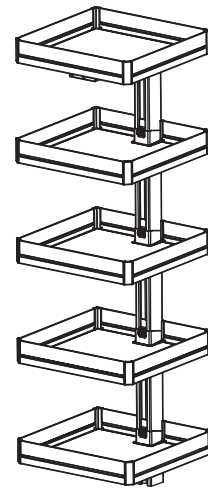

Basket is made of alloy  
(chromed purple)  
and tempered glass

**Loading Capacity**

Max Loading 75kg, each Basket  
Max loading 15kg. Suggesting cabinet  
door being mounted with 165\* hinge

Unique linkage design, open the door at the same time with all the baskets, convenient storage. Mute design, so that the product in the process of opening and closing, always maintain a smooth and smooth effect. Double guide rail design, a change of the previous single guide rail mode, strengthen the bearing capacity of the product.



**AIRCRAFT CARRIER CABIN**

| PRODUCT CODE  | SPECIFICATION (W x D x H)  | CARCASE SIZE | DESCRIPTION | FINISH             | TYPE       |
|---------------|----------------------------|--------------|-------------|--------------------|------------|
| PCACC - 70714 | (404 x 424) x 500 x 1780mm | 450mm        | 5 Basket    | Upgrade Grey Glass | Soft Close |
| PCACC - 70715 | (564 x 574) x 500 x 1780mm | 600mm        | 5 Basket    | Upgrade Grey Glass | Soft Close |

# HIGH END KITCHEN STORAGE PURPLE CRYSTAL

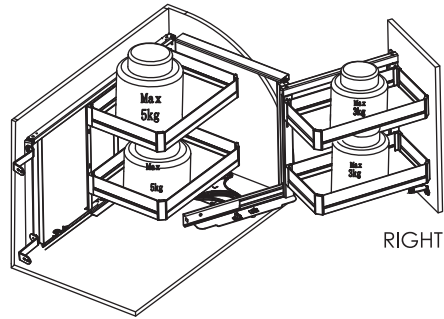
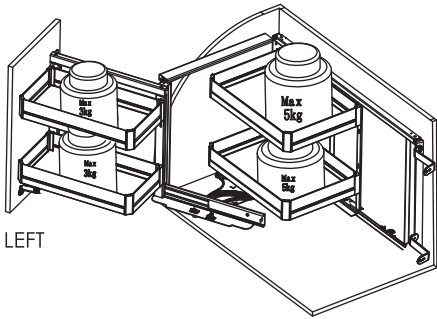

## Loading Capacity

Max Load of each bigger Basket is 5kg, Max load of each smaller Basket is 3kg.

Basket is made of alloy (chromed purple) and tempered glass

Little monster series, make full use of kitchen corner space, realize all articles pull out Cabinet width body.



## MAGIC CORNER

| PRODUCT CODE         | SPECIFICATION (W x D x H) | CARCASE SIZE | DESCRIPTION   | FINISH             | TYPE       |
|----------------------|---------------------------|--------------|---------------|--------------------|------------|
| PCMC - 70711 (LEFT)  | (860-960) x 530 x 520mm   | 900-1000mm   | Left Opening  | Upgrade Grey Glass | Soft Close |
| PCMC - 70711 (RIGHT) | (860-960) x 530 x 520mm   | 900-1000mm   | Right Opening | Upgrade Grey Glass | Soft Close |



HIGH END KITCHEN STORAGE  
**PURPLE CRYSTAL**

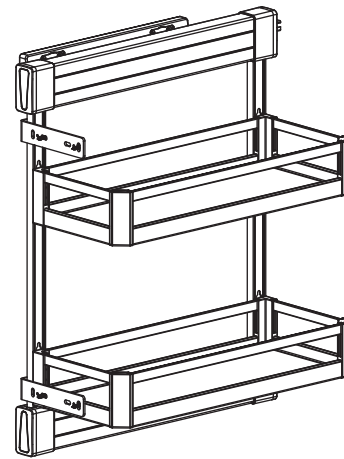

Basket is made of alloy (chromed purple) and tempered glass

**Loading Capacity**

**Germany Brand HURMAR Soft-Close** synchronous slide, smooth movement Max loading 30kg

Simplicity, comfortable home, cutting-edge technology, exquisite craft, art and life perfectly fit.



**SIDE MOUNTED PULLOUT**

| PRODUCT CODE  | SPECIFICATION (W x D x H) | CARCASE SIZE | DESCRIPTION | FINISH             | TYPE       |
|---------------|---------------------------|--------------|-------------|--------------------|------------|
| PCSMP - 70716 | 135 x 485 x 580mm         | 200mm        | 2 Basket    | Upgrade Grey Glass | Soft Close |
| PCSMP - 70717 | 235 x 485 x 580mm         | 300mm        | 2 Basket    | Upgrade Grey Glass | Soft Close |

HIGH END KITCHEN STORAGE  
**ENCANTO**

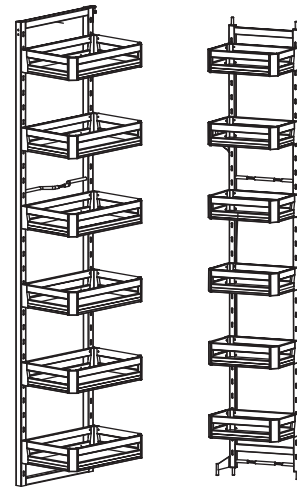

Basket is made of Aluminium

**Surface treatment**  
Fluorocarbon coating

**Loading Capacity**  
Max Loading for each bigger Basket 5kg,  
Max loading for each smaller Basket 3kg.

Slim side design, interpreting minimalism and light luxury style, enhance the taste of kitchen storage. The bottom is covered by non-slip mat, prevent the items from collision, and convenient to clean at the same time.



**PANTRY ROLL OUT**

| PRODUCT CODE | SPECIFICATION (W x D x H) | CARCASE SIZE | DESCRIPTION | FINISH | TYPE       |
|--------------|---------------------------|--------------|-------------|--------|------------|
| EPRO - 60612 | 405 x 500 x 1780mm        | 450mm        | 6 Basket    | Grey   | Soft Close |
| EPRO - 60613 | 555 x 500 x 1780mm        | 600mm        | 6 Basket    | Grey   | Soft Close |

HIGH END KITCHEN STORAGE  
**ENCANTO**

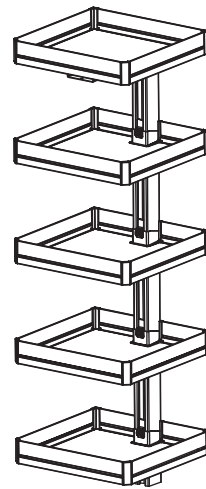

Basket is made of Aluminium

**Surface treatment**  
Fluorocarbon coating

**Loading Capacity**

Max Loading 75kg, each Basket Max loading 15kg. Suggesting cabinet door being mounted with 165\* hinge

Unique linkage design, open the door at the same time with all the baskets, convenient storage. Mute design, so that the product in the process of opening and closing, always maintain a smooth and smooth effect. Double guide rail design, a change of the previous single guide rail mode, strengthen the bearing capacity of the product.



**AIRCRAFT CARRIER CABIN**

| PRODUCT CODE | SPECIFICATION (W x D x H) | CARCASE SIZE | DESCRIPTION | FINISH | TYPE       |
|--------------|---------------------------|--------------|-------------|--------|------------|
| EACC - 60614 | (404-424) x 500 x 1780mm  | 450mm        | 5 Basket    | Grey   | Soft Close |
| EACC - 60615 | (554-574) x 500 x 1780mm  | 600mm        | 5 Basket    | Grey   | Soft Close |

# HIGH END KITCHEN STORAGE ENCANTO

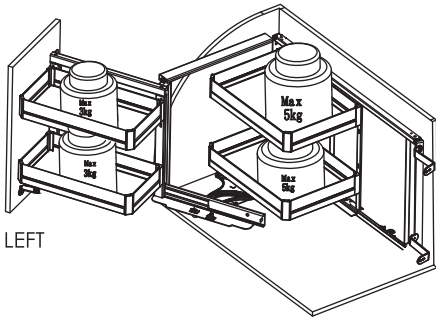

LEFT

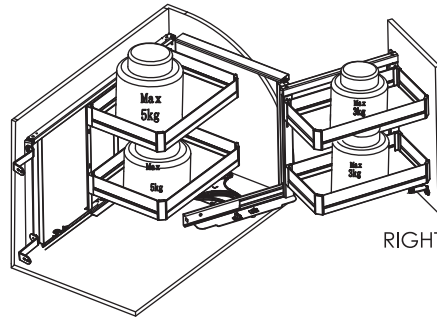

RIGHT

### Loading Capacity

Max Load of each bigger Basket is 5kg, Max load of each smaller Basket is 3kg.

### Surface treatment

Fluorocarbon coating

Basket is made of Aluminium

Little monster series, make full use of kitchen corner space, realize all articles pull out Cabinet width body.



## MAGIC CORNER

| PRODUCT CODE        | SPECIFICATION (W x D x H) | CARCASE SIZE | DESCRIPTION   | FINISH | TYPE       |
|---------------------|---------------------------|--------------|---------------|--------|------------|
| EMC - 60611 (LEFT)  | (860-960) x 530 x 520mm   | 900-1000mm   | Left Opening  | Grey   | Soft Close |
| EMC - 60611 (RIGHT) | (860-960) x 530 x 520mm   | 900-1000mm   | Right Opening | Grey   | Soft Close |



HIGH END KITCHEN STORAGE  
**ENCANTO**

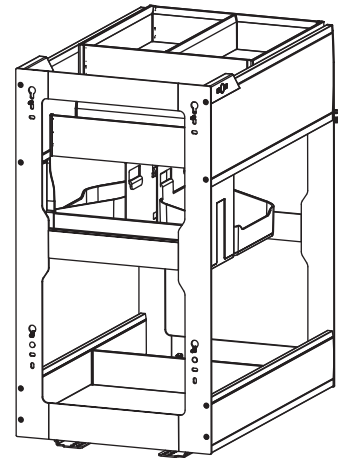

Basket is made of Aluminium

**Surface treatment**  
Fluorocarbon coating

**Loading Capacity**  
Germany Brand **HURMAR Soft-Close** synchronize slide, smooth movement Max loading 30kg

Simplicity, comfortable home, cutting edge technology, exquisite craft, art and life perfectly fit.

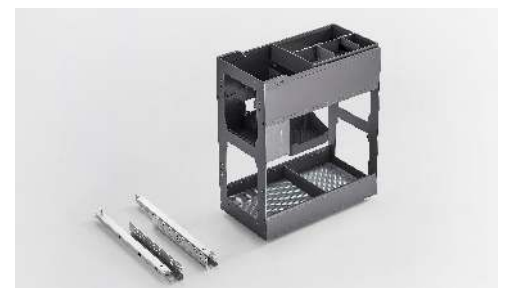

**MULTI FUNCTION PULLOUT**

| PRODUCT CODE | SPECIFICATION (W x D x H) | CARCASE SIZE | DESCRIPTION | FINISH | TYPE       |
|--------------|---------------------------|--------------|-------------|--------|------------|
| EMFP - 60617 | 264 x 470 x 552mm         | 300mm        | 2 Basket    | Grey   | Soft Close |

HIGH END KITCHEN STORAGE  
**ENCANTO**



Basket is made of Aluminium

**Surface treatment**  
Fluorocarbon coating

**Loading Capacity**  
Germany Brand **HURMAR Soft-Close** synchronize slide, smooth movement Max loading 30kg

Simplicity, comfortable home, cutting edge technology, exquisite craft, art and life perfectly fit.



**BOTTOM MOUNTED PULLOUT**

| PRODUCT CODE | SPECIFICATION (W x D x H) | CARCASE SIZE | DESCRIPTION | FINISH | TYPE       |
|--------------|---------------------------|--------------|-------------|--------|------------|
| EBMP - 60616 | 164 x 470 x 552mm         | 200mm        | 2 Basket    | Grey   | Soft Close |



**OYA - CUTLERY TRAY**

| PRODUCT CODE | CARCASE SIZE | FINISH |
|--------------|--------------|--------|
| OCT - 450    | 450mm        | Grey   |
| OCT - 600    | 600mm        | Grey   |

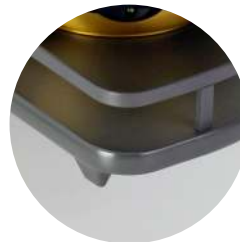

**S-CORNER**

|              |                          |
|--------------|--------------------------|
| PRODUCT CODE | SC - 01                  |
| FINISH       | Grey                     |
| DESCRIPTION  | Right/Left, Soft Closing |
| CARCASE SIZE | 900 - 1000mm             |



for installation video  
please scan barcode



High Load  
Capacity



Easy  
Installation







### SLIM TANDEM BOX

|                     |                         |             |             |             |             |             |
|---------------------|-------------------------|-------------|-------------|-------------|-------------|-------------|
| <b>PRODUCT CODE</b> | STB-01                  |             |             |             |             |             |
| <b>FINISH</b>       | Grey Matt               |             |             |             |             |             |
| <b>DESCRIPTION</b>  | Weight Capacity : 40 kg |             |             |             |             |             |
| <b>SIZE (H X D)</b> | 84 x 300mm              | 84 x 350mm  | 84 x 400mm  | 84 x 450mm  | 84 x 500mm  | 84 x 550mm  |
| <b>SIZE (H X D)</b> | 167 x 300mm             | 167 x 350mm | 167 x 400mm | 167 x 450mm | 167 x 500mm | 167 x 550mm |
| <b>SIZE (H X D)</b> | 199 x 300mm             | 199 x 350mm | 199 x 400mm | 199 x 450mm | 199 x 500mm | 199 x 550mm |

**STARRS**

Premium Hardware Fitting

## GLASS TANDEM BOX

|                     |                               |             |             |
|---------------------|-------------------------------|-------------|-------------|
| <b>PRODUCT CODE</b> | GTB-02                        |             |             |
| <b>FINISH</b>       | Grey Matt + Transparent Glass |             |             |
| <b>DESCRIPTION</b>  | Weight Capacity : 40 kg       |             |             |
| <b>SIZE (H X D)</b> | 84 x 400mm                    | 84 x 450mm  | 84 x 500mm  |
| <b>SIZE (H X D)</b> | 167 x 400mm                   | 167 x 450mm | 167 x 500mm |
| <b>SIZE (H X D)</b> | 199 x 400mm                   | 199 x 450mm | 199 x 500mm |



High Load Capacity



Easy Installation



### FRONT CONNECTOR (L&R)

| CODE    | SIZE           |
|---------|----------------|
| SFC-84  | Height : 84mm  |
| SFC-167 | Height : 167mm |
| SFC-199 | Height : 199mm |



### FRONT PANEL

|                     |               |
|---------------------|---------------|
| <b>PRODUCT CODE</b> | SFP-1200      |
| <b>MATERIAL</b>     | Aluminum      |
| <b>DESCRIPTION</b>  | Size : 1200mm |
| <b>FINISH</b>       | Grey Matt     |



### SQUARE BAR

|                     |               |
|---------------------|---------------|
| <b>PRODUCT CODE</b> | SSB-1200      |
| <b>MATERIAL</b>     | Aluminum      |
| <b>DESCRIPTION</b>  | Size : 1200mm |
| <b>FINISH</b>       | Grey Matt     |





**FULL GLASS  
FRONT CONNECTOR (L&R)**

| PRODUCT CODE | SIZE           |
|--------------|----------------|
| FG-FC-84     | Height : 84mm  |
| FG-FC-167    | Height : 167mm |
| FG-FC-199    | Height : 199mm |



**FRONT PANEL**

|              |               |
|--------------|---------------|
| PRODUCT CODE | GFP-1200      |
| MATERIAL     | Aluminum      |
| DESCRIPTION  | Size : 1200mm |
| FINISH       | Grey Matt     |



**HALF GLASS  
FRONT CONNECTOR (L&R)**

| PRODUCT CODE | SIZE           |
|--------------|----------------|
| HG-FC-167    | Height : 167mm |
| HG-FC-199    | Height : 199mm |



**FRONT PANEL**

|              |               |
|--------------|---------------|
| PRODUCT CODE | GFP-1200      |
| MATERIAL     | Aluminum      |
| DESCRIPTION  | Size : 1200mm |
| FINISH       | Grey Matt     |





|                     |  |
|---------------------|--|
| <b>PRODUCT NAME</b> | Non-Slip Drawer Mat                              |
| <b>SIZE</b>         | 10Mtrs (L) x 500mm (H)<br>20Mtrs (L) x 500mm (H) |
| <b>COLOUR</b>       | Dark Grey  |

**Features**

- Non-Slip Drawer Mat is perfectly manufactured for drawers, cabinets, cup-boards, shelves, desks, etc.
- It is made of BPA-Free and odourless EVA material which is non-slip, waterproof and flexible.
- This mat is supplied in rolls or can be cut into any shapes or size.
- It is non-adhesive, easy to clean and washable.

## SLIDING FITTINGS

Starrs offers a comprehensive collection of manual sliding door systems for a wide range of applications at home and work. Our large portfolio of door fittings enables users to create tailor-made solutions for virtually any requirement. The solid build quality and premium finishes of these metal fittings add to the overall aesthetic appeal of the place.





Pocket door sliding is an innovative idea to saving space. Instead of opening outwards, the door slides into the pockets on the sides of the unit. Pocket doors create a completely clear opening, allowing for easy movement from room to room. Pocket doors are a good option for smaller rooms that may not have space for a full-swing door. They are perfect for closets and small bedrooms where floor space counts.



for installation video  
please scan barcode

**TECHNICAL POINTS**

Application : Wooden Door | The depth of the cabinet : 420 - 600mm | Door thickness : 18 - 25mm  
 Door Weight : Single Door - 50kg | The height of the cabinet : 1720 - 2850mm

|                     |                     |
|---------------------|---------------------|
| <b>PRODUCT NAME</b> | Pocket Door Sliding |
| <b>PRODUCT CODE</b> | SPDS - LEFT         |

|                     |                     |
|---------------------|---------------------|
| <b>PRODUCT NAME</b> | Pocket Door Sliding |
| <b>PRODUCT CODE</b> | SPDS - RIGHT        |



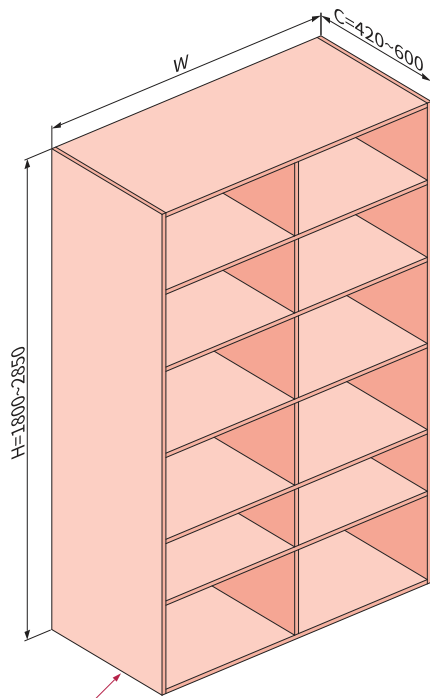
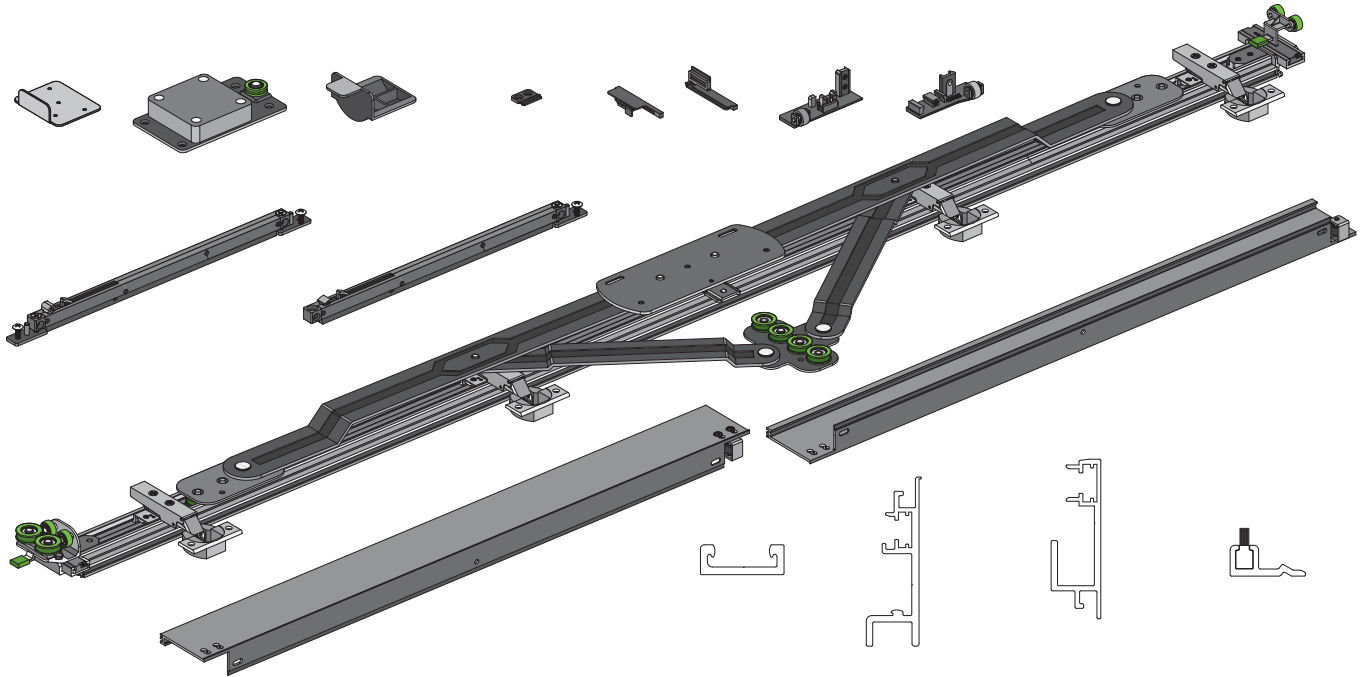

Note: No Baseboard

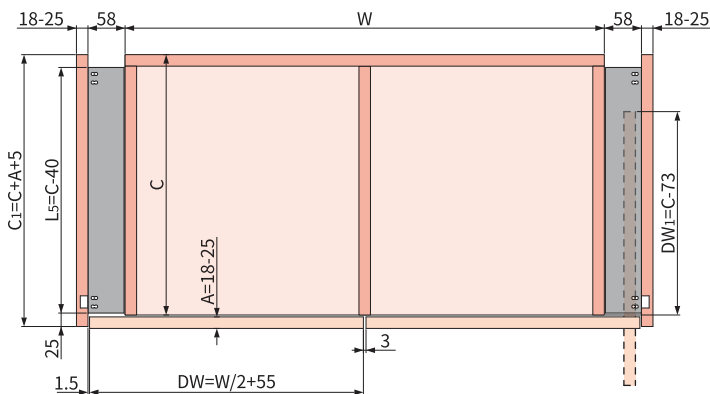

|     |                                 |    |   |
|-----|---------------------------------|----|---|
| A   | The thickness of the door panel | L1 | The length of the upper track                       |
| C   | The depth of the cabinet        | L2 | The length of the bottom track                      |
| C1  | The depth of the seal panel     | L3 | The length of the middle track                      |
| H   | The height of the cabinet       | L4 | The height of the axis                              |
| H1  | The height of the seal panel    | L5 | The length of the connected panel                   |
| DH  | The height of the door panel    | L6 | The length of the prole for weather strip & brusher |
| DW  | The width of the door panel     |    |   |
| DW1 | The depth of the pocket         | W  | The width of the cabinet                            |

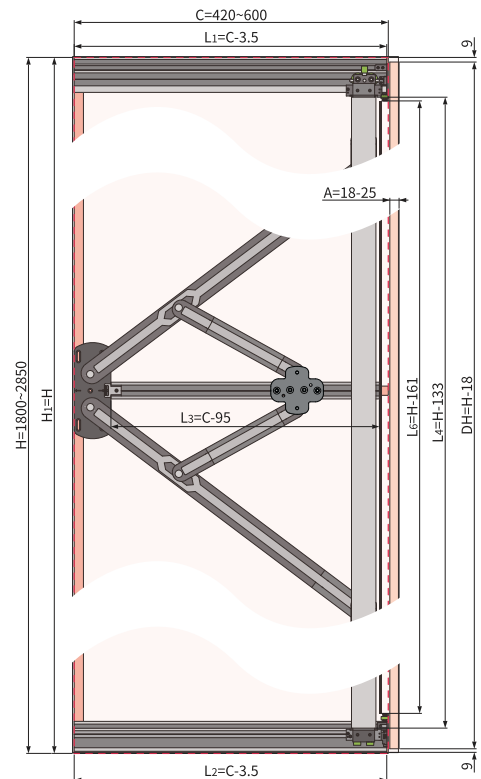





|                     |                            |
|---------------------|----------------------------|
| <b>PRODUCT CODE</b> | SSR-609                    |
| <b>DESCRIPTION</b>  | Soft Close Sliding Fitting |
| <b>TYPE</b>         | 2 Door Kit                 |
| <b>WEIGHT CAP.</b>  | 50 kg Per Door             |



|                     |                            |            |
|---------------------|----------------------------|------------|
| <b>PRODUCT CODE</b> | SSR-709                    |            |
| <b>DESCRIPTION</b>  | Soft Close Sliding Fitting |            |
| <b>TYPE</b>         | 2 Door Kit                 | 3 Door Kit |
| <b>WEIGHT CAP.</b>  | 50 kg Per Door             |            |

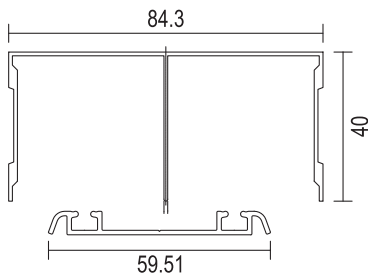

|                     |                                |
|---------------------|--------------------------------|
| <b>PRODUCT CODE</b> | SSC-609                        |
| <b>DESCRIPTION</b>  | Sliding Channel (Top & Bottom) |
| <b>SIZE</b>         | 2.5 Mtr, 3.97 Mtr              |
| <b>FINISH</b>       | Aluminium                      |

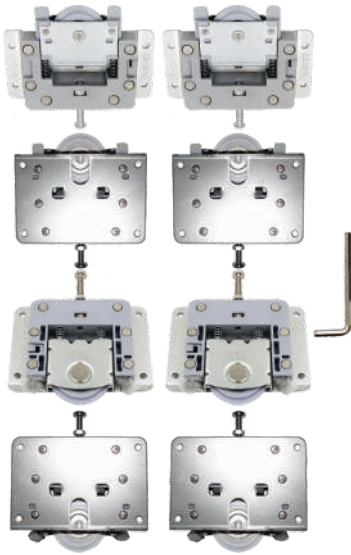

|                     |  |
|---------------------|--|
| <b>PRODUCT CODE</b> | SSR-409  |
| <b>DESCRIPTION</b>  | Soft Close Sliding Fitting (for inset wardrobe door) |
| <b>TYPE</b>         | 2 Door Kit   |
| <b>WEIGHT CAP.</b>  | 50 Kg. (One Door Max.)                               |

|                     |  |
|---------------------|--|
| <b>PRODUCT CODE</b> | SSR-509  |
| <b>DESCRIPTION</b>  | Soft Close Sliding Fitting (for inset wardrobe door) |
| <b>TYPE</b>         | 2 Door Kit   |
| <b>WEIGHT CAP.</b>  | 50 Kg. (One Door Max.)                               |



|                    |  |
|--------------------|--|
| <b>DESCRIPTION</b> | Soft Close Dampener (Use with SSR-409/509) |
|--------------------|--|

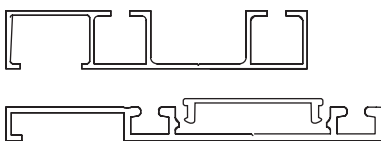

|                     |  |            |           |           |
|---------------------|--|------------|-----------|-----------|
| <b>PRODUCT CODE</b> | SSC-409                                |            |           |           |
| <b>DESCRIPTION</b>  | Sliding Channel (Use with SSR-409/509) |            |           |           |
| <b>SIZE</b>         | 2.43mtr. (8ft)                         |            |           |           |
| <b>FINISH</b>       | Aluminium                              | Matt black | Champagne | Iron grey |
| <b>SIZE</b>         | 3.66mtr. (12ft)                        |            |           |           |
| <b>FINISH</b>       | Aluminium                              |            |           |           |



for installation video please scan barcode

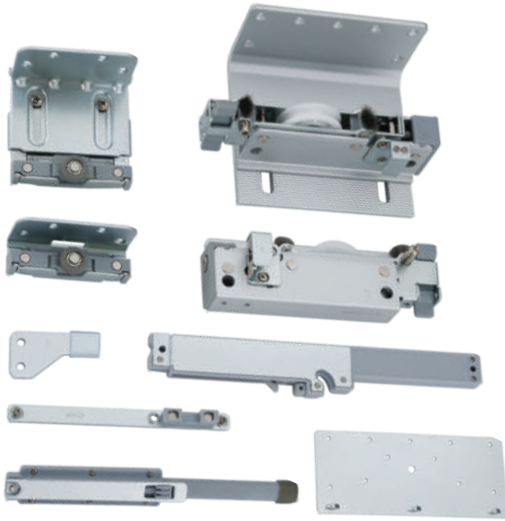

|                     |  |
|---------------------|--|
| <b>PRODUCT CODE</b> | SSR-602  |
| <b>DESCRIPTION</b>  | Soft Close Sliding Fitting (for overlay wardrobe door) |
| <b>TYPE</b>         | 2 Door Kit, 3 Door Kit                                 |
| <b>WEIGHT CAP.</b>  | 80 Kg. (One Door Max.)                                 |

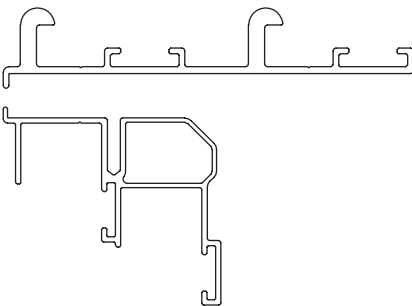

|                     |                                    |
|---------------------|------------------------------------|
| <b>PRODUCT CODE</b> | SSC-602                            |
| <b>DESCRIPTION</b>  | Sliding Channel (Use with SSR-602) |
| <b>SIZE</b>         | 3mtr. (10ft), 3.66mtr. (12ft)      |
| <b>FINISH</b>       | Aluminium                          |



|                     |                                   |                      |
|---------------------|-----------------------------------|----------------------|
| <b>PRODUCT CODE</b> | SSR-04                            | Weight Cap. : 40 kg. |
| <b>PRODUCT CODE</b> | SSR-08                            | Weight Cap. : 60 kg. |
| <b>DESCRIPTION</b>  | Sliding Roller (4 Wheel, 8 Wheel) |                      |



|                     |                                      |
|---------------------|--------------------------------------|
| <b>PRODUCT CODE</b> | SSC-04/08                            |
| <b>DESCRIPTION</b>  | Sliding Channel (Use with SSR-04/08) |
| <b>SIZE</b>         | 12 ft, 13 ft, 16 ft                  |
| <b>FINISH</b>       | Aluminium                            |



|                     |                |
|---------------------|----------------|
| <b>PRODUCT CODE</b> | SSR-01         |
| <b>DESCRIPTION</b>  | Sliding Roller |
| <b>TYPE</b>         | 2 Door Kit     |



|                     |                                   |
|---------------------|-----------------------------------|
| <b>PRODUCT CODE</b> | SSC-01                            |
| <b>DESCRIPTION</b>  | Sliding Channel (Use with SSR-01) |
| <b>SIZE</b>         | 10 ft, 12 ft                      |
| <b>FINISH</b>       | Aluminium                         |



for installation video please scan barcode



A telescopic door system is the best choice for limited space and heavy doors. This eliminates any need for use of the space normally required for swinging doors to open into a room interior. With the telescopic frame installed, two door panels can slide into the same adjoining wall, permitting full opening of the wide doorway and admittance of all exterior light into the room. Doors are equipped with soft close mechanism.

**DIAGRAM**

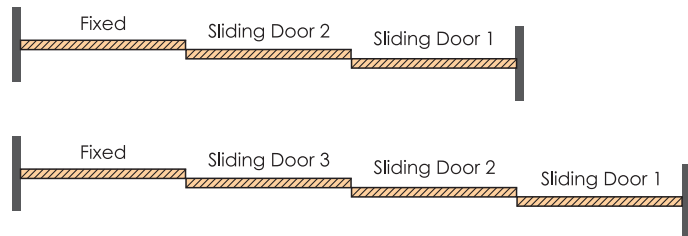

|                     |                            |               |
|---------------------|----------------------------|---------------|
| <b>PRODUCT NAME</b> | Telescopic Sliding Roller  |               |
| <b>PRODUCT CODE</b> | SSR-314 (1+2)              | SSR-314 (1+3) |
| <b>DESCRIPTION</b>  | Noise Less Sliding Fitting |               |
| <b>TYPE</b>         | Both Side Soft Close       |               |
| <b>WEIGHT CAP.</b>  | 80 Kg.                     |               |



|                     |                            |               |
|---------------------|----------------------------|---------------|
| <b>PRODUCT NAME</b> | Telescopic Sliding Roller  |               |
| <b>PRODUCT CODE</b> | SSR-315 (1+2)              | SSR-315 (1+3) |
| <b>DESCRIPTION</b>  | Heavy Door Sliding Fitting |               |
| <b>TYPE</b>         | Both Side Soft Close       |               |
| <b>WEIGHT CAP.</b>  | 120 Kg.                    |               |

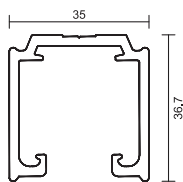

|                     |                 |
|---------------------|-----------------|
| <b>PRODUCT NAME</b> | SSC-14          |
| <b>DESCRIPTION</b>  | Sliding Channel |
| <b>SIZE</b>         | 3 Mtr, 3.97 Mtr |
| <b>FINISH</b>       | Matt Black      |

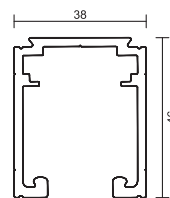

|                     |                       |
|---------------------|-----------------------|
| <b>PRODUCT CODE</b> | SSC-12                |
| <b>DESCRIPTION</b>  | Heavy Sliding Channel |
| <b>SIZE</b>         | 3 Mtr, 3.97 Mtr       |
| <b>FINISH</b>       | Matt Black            |

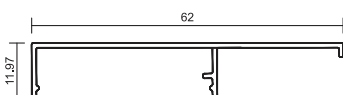

|                     |                |
|---------------------|----------------|
| <b>PRODUCT NAME</b> | Track Cover    |
| <b>PRODUCT CODE</b> | SSTC-14        |
| <b>SIZE</b>         | 3 Mtr, 3.97Mtr |
| <b>FINISH</b>       | Matt Black     |

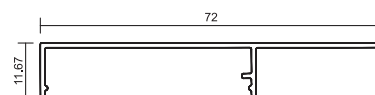

|                     |                |
|---------------------|----------------|
| <b>PRODUCT NAME</b> | Track Cover    |
| <b>PRODUCT CODE</b> | SSTC-12        |
| <b>SIZE</b>         | 3 Mtr, 3.97Mtr |
| <b>FINISH</b>       | Matt Black     |





Sync sliding system is a solution specifically designed to realize wooden doors with synchronized opening motion. Extremely easy to install, saving time and energy and it makes an environmentally friendly option. Ideal to create partitions in living space, this system can be configured to have their Synchronized Sliding mechanism. Doors are equipped with soft close mechanism.

**DIAGRAM**

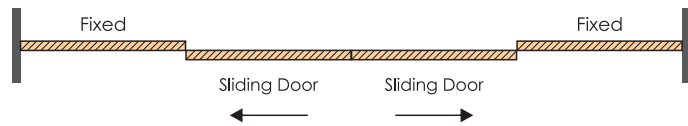

|                     |                            |
|---------------------|----------------------------|
| <b>PRODUCT NAME</b> | Synchronize Sliding Roller |
| <b>PRODUCT CODE</b> | SSR-414                    |
| <b>DESCRIPTION</b>  | Sliding Fitting            |
| <b>TYPE</b>         | Both Side Soft Close       |
| <b>WEIGHT CAP.</b>  | 80 Kg.                     |



|                     |                            |
|---------------------|----------------------------|
| <b>PRODUCT NAME</b> | Synchronize Sliding Roller |
| <b>PRODUCT CODE</b> | SSR-415                    |
| <b>DESCRIPTION</b>  | Heavy Door Sliding Fitting |
| <b>TYPE</b>         | Both Side Soft Close       |
| <b>WEIGHT CAP.</b>  | 120 Kg.                    |

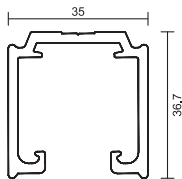

|                     |                 |
|---------------------|-----------------|
| <b>PRODUCT NAME</b> | SSC-14          |
| <b>DESCRIPTION</b>  | Sliding Channel |
| <b>SIZE</b>         | 3 Mtr, 3.97 Mtr |
| <b>FINISH</b>       | Matt Black      |

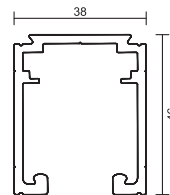

|                     |                       |
|---------------------|-----------------------|
| <b>PRODUCT CODE</b> | SSC-12                |
| <b>DESCRIPTION</b>  | Heavy Sliding Channel |
| <b>SIZE</b>         | 3 Mtr, 3.97 Mtr       |
| <b>FINISH</b>       | Matt Black            |

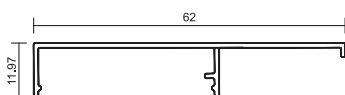

|                     |                |
|---------------------|----------------|
| <b>PRODUCT NAME</b> | Track Cover    |
| <b>PRODUCT CODE</b> | SSTC-14        |
| <b>SIZE</b>         | 3 Mtr, 3.97Mtr |
| <b>FINISH</b>       | Matt Black     |

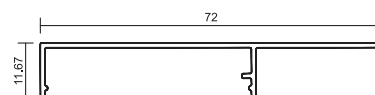

|                     |                |
|---------------------|----------------|
| <b>PRODUCT NAME</b> | Track Cover    |
| <b>PRODUCT CODE</b> | SSTC-12        |
| <b>SIZE</b>         | 3 Mtr, 3.97Mtr |
| <b>FINISH</b>       | Matt Black     |



|                     |                              |
|---------------------|------------------------------|
| <b>PRODUCT CODE</b> | SSR-10                       |
| <b>DESCRIPTION</b>  | Heavy Door Sliding Fitting   |
| <b>TYPE</b>         | Without Soft Close           |
| <b>WEIGHT CAP.</b>  | 80 - 120 Kg. (One Door Max.) |



|                     |                                       |
|---------------------|---------------------------------------|
| <b>PRODUCT CODE</b> | SSR-11                                |
| <b>DESCRIPTION</b>  | Soft Close Heavy Door Sliding Fitting |
| <b>TYPE</b>         | 1 Side Soft Close                     |
| <b>WEIGHT CAP.</b>  | 80 - 120 Kg. (One Door Max.)          |



|                     |                                       |
|---------------------|---------------------------------------|
| <b>PRODUCT CODE</b> | SSR-12                                |
| <b>DESCRIPTION</b>  | Soft Close Heavy Door Sliding Fitting |
| <b>TYPE</b>         | Both Side Soft Close                  |
| <b>WEIGHT CAP.</b>  | 80 - 120 Kg. (One Door Max.)          |

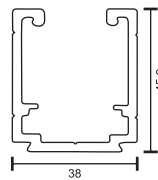

|                     |                                 |
|---------------------|---------------------------------|
| <b>PRODUCT CODE</b> | SSC-10/11/12                    |
| <b>DESCRIPTION</b>  | Heavy Sliding Channel           |
| <b>SIZE</b>         | 2.43mtr. (8ft), 3.97mtr. (13ft) |
| <b>FINISH</b>       | Aluminium                       |





SLIDING FITTINGS

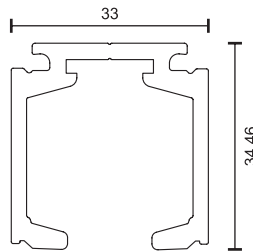
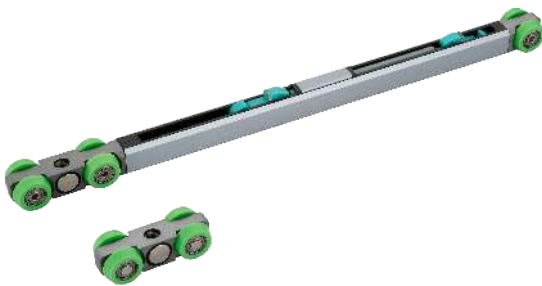

|                     |                                 |
|---------------------|---------------------------------|
| <b>PRODUCT CODE</b> | SSR-13                          |
| <b>DESCRIPTION</b>  | Noise Less Sliding Door Fitting |
| <b>TYPE</b>         | Both Side Soft Close            |
| <b>WEIGHT CAP.</b>  | 60 - 80 Kg. (One Door Max.)     |

|                     |                                 |
|---------------------|---------------------------------|
| <b>PRODUCT CODE</b> | SSC-13                          |
| <b>DESCRIPTION</b>  | Sliding Channel                 |
| <b>SIZE</b>         | 2.43mtr. (8ft), 3.97mtr. (13ft) |
| <b>FINISH</b>       | Aluminium                       |



|                     |                   |
|---------------------|-------------------|
| <b>PRODUCT CODE</b> | SMR-01            |
| <b>DESCRIPTION</b>  | Magnifying Mirror |
| <b>MATERIAL</b>     | Brass             |



|                     |                            |
|---------------------|----------------------------|
| <b>PRODUCT CODE</b> | SMR-03                     |
| <b>DESCRIPTION</b>  | Magnifying Mirror with LED |
| <b>MATERIAL</b>     | Brass                      |

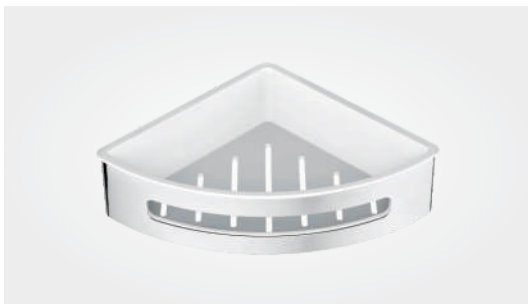

|                     |              |                       |
|---------------------|--------------|-----------------------|
| <b>PRODUCT CODE</b> | 7009         | Size : 206 x 206 x 56 |
| <b>PRODUCT CODE</b> | 7010         | Size : 245 x 245 x 55 |
| <b>DESCRIPTION</b>  | SS Corner    |                       |
| <b>MATERIAL</b>     | SS 304 + ABS |                       |



|                     |                |                       |
|---------------------|----------------|-----------------------|
| <b>PRODUCT CODE</b> | 7011           | Size : 290 x 123 x 56 |
| <b>PRODUCT CODE</b> | 7012           | Size : 350 x 123 x 55 |
| <b>DESCRIPTION</b>  | SS Front Shelf |                       |
| <b>MATERIAL</b>     | SS 304 + ABS   |                       |



|                     |              |           |
|---------------------|--------------|-----------|
| <b>PRODUCT NAME</b> | Glass Corner |           |
| <b>DESCRIPTION</b>  | Toughened    |           |
| <b>SIZE</b>         | 10" x 10"    | 12" x 12" |

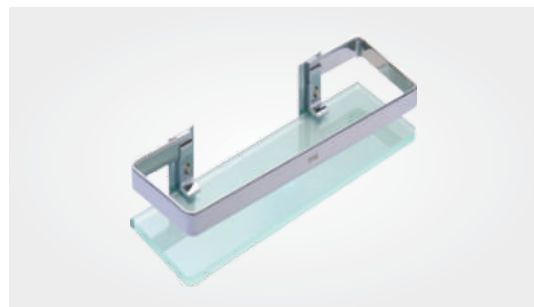

|                     |             |     |
|---------------------|-------------|-----|
| <b>PRODUCT NAME</b> | Glass Shelf |     |
| <b>DESCRIPTION</b>  | Toughened   |     |
| <b>SIZE</b>         | 16"         | 20" |



|                     |                     |
|---------------------|---------------------|
| <b>PRODUCT CODE</b> | 7004                |
| <b>DESCRIPTION</b>  | Foot Rest with Hook |
| <b>MATERIAL</b>     | Brass               |





CLOTH HOOKS



|                     |              |       |
|---------------------|--------------|-------|
| <b>PRODUCT CODE</b> | SCH-2003     | 3 Pin |
| <b>PRODUCT CODE</b> | SCH-2006     | 6 Pin |
| <b>FINISH</b>       | Satin Nickle |       |



|                     |              |       |
|---------------------|--------------|-------|
| <b>PRODUCT CODE</b> | SCH-1002     | 2 Pin |
| <b>PRODUCT CODE</b> | SCH-1004     | 4 Pin |
| <b>FINISH</b>       | Satin Nickle |       |



|                     |          |       |       |
|---------------------|----------|-------|-------|
| <b>PRODUCT CODE</b> | SCH-4006 |       |       |
| <b>FINISH</b>       | Chrome   |       |       |
| <b>SIZE</b>         | 2 Pin    | 4 Pin | 6 Pin |



|                     |          |       |       |
|---------------------|----------|-------|-------|
| <b>PRODUCT CODE</b> | SCH-5006 |       |       |
| <b>FINISH</b>       | White+CP |       |       |
| <b>SIZE</b>         | 2 Pin    | 4 Pin | 6 Pin |



|                     |          |       |
|---------------------|----------|-------|
| <b>PRODUCT CODE</b> | SCH-6000 |       |
| <b>FINISH</b>       | Chrome   |       |
| <b>SIZE</b>         | 4 Pin    | 6 Pin |



|                     |               |       |
|---------------------|---------------|-------|
| <b>PRODUCT CODE</b> | SCH-6100      |       |
| <b>FINISH</b>       | Satin + Black |       |
| <b>SIZE</b>         | 4 Pin         | 6 Pin |



|                     |               |       |
|---------------------|---------------|-------|
| <b>PRODUCT CODE</b> | SCH-6200      |       |
| <b>FINISH</b>       | Grey + RG PVD |       |
| <b>SIZE</b>         | 4 Pin         | 6 Pin |



|                     |          |       |
|---------------------|----------|-------|
| <b>PRODUCT CODE</b> | SCH-6300 |       |
| <b>FINISH</b>       | SS Matt  |       |
| <b>SIZE</b>         | 4 Pin    | 6 Pin |

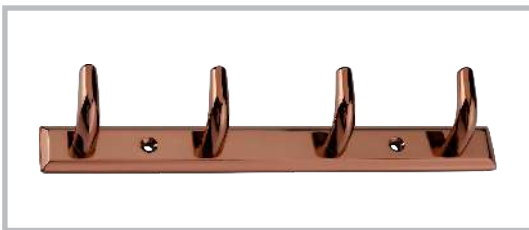

|                     |               |       |
|---------------------|---------------|-------|
| <b>PRODUCT CODE</b> | SCH-6400      |       |
| <b>FINISH</b>       | Rose Gold PVD |       |
| <b>SIZE</b>         | 4 Pin         | 6 Pin |



|                     |                |       |
|---------------------|----------------|-------|
| <b>PRODUCT CODE</b> | SCH-6500       |       |
| <b>FINISH</b>       | Antique, Black |       |
| <b>SIZE</b>         | 4 Pin          | 6 Pin |



|                     |                         |       |
|---------------------|-------------------------|-------|
| <b>PRODUCT CODE</b> | SCH-6600                |       |
| <b>FINISH</b>       | Gold PVD, Rose Gold PVD |       |
| <b>SIZE</b>         | 4 Pin                   | 6 Pin |





S/S PIPES



|                     |                 |
|---------------------|-----------------|
| <b>PRODUCT CODE</b> | SSP-19          |
| <b>DESCRIPTION</b>  | Round Pipe 19mm |
| <b>MATERIAL</b>     | Stainless Steel |
| <b>FINISH</b>       | Chrome          |
| <b>SIZE</b>         | 12 ft           |



|                     |                 |
|---------------------|-----------------|
| <b>PRODUCT CODE</b> | SSP-25          |
| <b>DESCRIPTION</b>  | Round Pipe 25mm |
| <b>MATERIAL</b>     | Stainless Steel |
| <b>FINISH</b>       | Chrome    Satin |
| <b>SIZE</b>         | 12 ft           |



|                     |                     |
|---------------------|---------------------|
| <b>PRODUCT CODE</b> | SSP-30              |
| <b>DESCRIPTION</b>  | Oval Pipe 15 x 30mm |
| <b>MATERIAL</b>     | Stainless Steel     |
| <b>FINISH</b>       | Chrome    Satin     |
| <b>SIZE</b>         | 12 ft               |



Versatile Starrs hinge systems feature fine-tuned movements in varied styles to suit different door movements. A sturdy metal build coupled with precision craftsmanship of Starrs designers make them amazingly functional and durable.







|                     |                             |
|---------------------|-----------------------------|
| <b>PRODUCT CODE</b> | HSC-20                      |
| <b>DESCRIPTION</b>  | Soft Close Hinge (Slide on) |
| <b>SIZE</b>         | 0 / 8 / 15 Crank            |



|                     |   |
|---------------------|---|
| <b>PRODUCT CODE</b> | HSC-25  |
| <b>DESCRIPTION</b>  | Soft Close Hinge, 3D Adjustment. Use for <b>(20-22mm)</b> Aluminium Profile |
| <b>SIZE</b>         | Full Overlay  |



|                     |  |
|---------------------|--|
| <b>PRODUCT CODE</b> | HSC-26   |
| <b>DESCRIPTION</b>  | Soft Close Hinge, 3D Adjustment. Use for <b>(25mm)</b> Aluminium Profile |
| <b>SIZE</b>         | Full Overlay   |



|                     |  |
|---------------------|--|
| <b>PRODUCT CODE</b> | HSC-30                                       |
| <b>DESCRIPTION</b>  | 3D Adjustment (2 way-small angle soft close) |
| <b>SIZE</b>         | 0 / 8 / 15 Crank                             |
| <b>FINISH</b>       | Gun Black                                    |



|                     |                                 |
|---------------------|---------------------------------|
| <b>PRODUCT CODE</b> | HSC-35                          |
| <b>DESCRIPTION</b>  | Soft Close Hinge, 3D Adjustment |
| <b>SIZE</b>         | 0 / 8 / 15 Crank                |



|                     |  |
|---------------------|--|
| <b>PRODUCT CODE</b> | HSC-40   |
| <b>DESCRIPTION</b>  | Soft Close Hinge                               |
| <b>SIZE</b>         | Thick Door <b>(16-30mm)</b> , 0 / 8 / 15 Crank |



|                     |                            |
|---------------------|----------------------------|
| <b>PRODUCT CODE</b> | HSC-45                     |
| <b>DESCRIPTION</b>  | Blind Soft Close Hinge 45° |



|                     |                            |
|---------------------|----------------------------|
| <b>PRODUCT CODE</b> | HSC-90                     |
| <b>DESCRIPTION</b>  | Blind Soft Close Hinge 90° |



|                     |               |
|---------------------|---------------|
| <b>PRODUCT CODE</b> | Z-90          |
| <b>DESCRIPTION</b>  | Pie/Bio Hinge |



|                     |                         |
|---------------------|-------------------------|
| <b>PRODUCT CODE</b> | HSC-165                 |
| <b>DESCRIPTION</b>  | Corner Soft Close Hinge |



|                     |                         |
|---------------------|-------------------------|
| <b>PRODUCT CODE</b> | HSC-S/S 304 (3D)        |
| <b>DESCRIPTION</b>  | 3D-S/S Soft Close Hinge |
| <b>SIZE</b>         | 0 / 8 / 15 Crank        |



|                     |                      |
|---------------------|----------------------|
| <b>PRODUCT CODE</b> | HSC-S/S 304A         |
| <b>DESCRIPTION</b>  | S/S Soft Close Hinge |
| <b>SIZE</b>         | 0 / 8 / 15 Crank     |



|                     |                                |
|---------------------|--------------------------------|
| <b>PRODUCT NAME</b> | Air Concealed Soft Close Hinge |
| <b>DESCRIPTION</b>  | One Set 2 Pcs (Right & Left)   |
| <b>WEIGHT CAP.</b>  | 20 kg                          |



|                     |                              |
|---------------------|------------------------------|
| <b>PRODUCT NAME</b> | Air Hinge - Cover            |
| <b>DESCRIPTION</b>  | One Set 2 Pcs (Right & Left) |

## DRAWER SLIDES

Stars high-quality metal runners and rail fittings make sure your kitchen, wardrobe and bathroom drawers slide smoothly and glitch-free. Sturdy form-factor and judicious design ensure for a seamless glide-through, adding to the functionality of drawers and user experience.





**FULL EXTENSION  
SYNCHRONIZE SOFT CLOSE QUADRO**

|                     |             |             |             |             |             |             |             |             |
|---------------------|-------------|-------------|-------------|-------------|-------------|-------------|-------------|-------------|
| <b>PRODUCT CODE</b> | SFSQ -10"   | SFSQ -12"   | SFSQ -14"   | SFSQ -16"   | SFSQ -18"   | SFSQ -20"   | SFSQ -22"   | SFSQ -24"   |
| <b>SIZE</b>         | 10" (250mm) | 12" (300mm) | 14" (350mm) | 16" (400mm) | 18" (450mm) | 20" (500mm) | 22" (550mm) | 24" (600mm) |



**Telescopic Slide**

|               |      |     |     |     |     |     |     |     |     |  |
|---------------|------|-----|-----|-----|-----|-----|-----|-----|-----|--|
| <b>FINISH</b> | Zinc |     |     |     |     |     |     |     |     |  |
| <b>SIZE</b>   | 8"   | 10" | 12" | 14" | 16" | 18" | 20" | 22" | 24" |  |

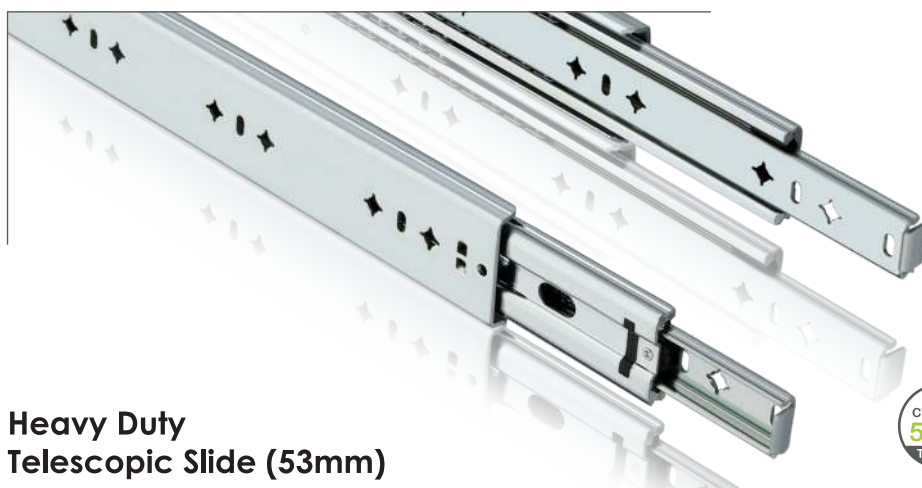

**Heavy Duty  
Telescopic Slide (53mm)**

|               |      |     |     |     |     |     |     |     |     |     |     |     |  |
|---------------|------|-----|-----|-----|-----|-----|-----|-----|-----|-----|-----|-----|--|
| <b>FINISH</b> | Zinc |     |     |     |     |     |     |     |     |     |     |     |  |
| <b>SIZE</b>   | 14"  | 16" | 18" | 20" | 22" | 24" | 28" | 30" | 32" | 34" | 36" | 42" |  |







**Soft Close  
Telescopic Slide**

|               |      |     |     |     |     |     |     |  |  |
|---------------|------|-----|-----|-----|-----|-----|-----|--|--|
| <b>FINISH</b> | Zinc |     |     |     |     |     |     |  |  |
| <b>SIZE</b>   | 10"  | 12" | 14" | 16" | 18" | 20" | 22" |  |  |



**Stainless Steel  
Slide**

|               |                       |     |     |     |     |  |  |  |  |
|---------------|-----------------------|-----|-----|-----|-----|--|--|--|--|
| <b>FINISH</b> | S.S. (Grade : SS 201) |     |     |     |     |  |  |  |  |
| <b>SIZE</b>   | 12"                   | 14" | 16" | 18" | 20" |  |  |  |  |



**Black  
Telescopic Slide**

|               |       |     |     |     |     |     |     |     |  |
|---------------|-------|-----|-----|-----|-----|-----|-----|-----|--|
| <b>FINISH</b> | Black |     |     |     |     |     |     |     |  |
| <b>SIZE</b>   | 10"   | 12" | 14" | 16" | 18" | 20" | 22" | 24" |  |



**Wardrobe Lock**

|                     |                                   |      |      |
|---------------------|-----------------------------------|------|------|
| <b>PRODUCT CODE</b> | WRDL                              |      |      |
| <b>DESCRIPTION</b>  | Dimple key, Brass Bolt, Brass key |      |      |
| <b>FINISH</b>       | SS                                |      |      |
| <b>SIZE</b>         | 25mm                              | 30mm | 35mm |



**Drawer Lock**

|                     |                                   |      |
|---------------------|-----------------------------------|------|
| <b>PRODUCT CODE</b> | DRWL                              |      |
| <b>DESCRIPTION</b>  | Dimple key, Brass Bolt, Brass key |      |
| <b>FINISH</b>       | SS                                |      |
| <b>SIZE</b>         | 20mm                              | 25mm |





## FURNITURE FITTINGS

Furniture adds the much-needed augmentation and convenience to interiors. But, it's the complex furniture fittings that hold a furniture piece together and truly contribute to its functionality and aesthetic appeal.





CABINET STAY



**Bio Fold Lift Up**

|                     |                     |
|---------------------|---------------------|
| <b>PRODUCT CODE</b> | SBFL-121            |
| <b>DESCRIPTION</b>  | Use for Double Door |
| <b>WEIGHT CAP.</b>  | 7 - 8.5 kg          |

**CABINET SIZE (MM)**

| H   | W    | T  |
|-----|------|----|
| 700 | 900  | 18 |
| 700 | 1000 | 18 |
| 800 | 800  | 18 |
| 800 | 900  | 18 |



for installation video  
please scan barcode

**Bio Fold Lift Up**

|                    |                     |
|--------------------|---------------------|
| <b>ITEM</b>        | SBFL-125            |
| <b>DESCRIPTION</b> | Use for Double Door |
| <b>WEIGHT CAP.</b> | 5.5 - 7 kg          |

**CABINET SIZE (MM)**

| H   | W    | T  |
|-----|------|----|
| 600 | 800  | 18 |
| 600 | 900  | 18 |
| 600 | 1000 | 18 |



for installation video  
please scan barcode



CABINET STAY



**Cabinet Stay**

|                     |                     |
|---------------------|---------------------|
| <b>PRODUCT CODE</b> | SHS -122            |
| <b>DESCRIPTION</b>  | Use for Single Door |
| <b>WEIGHT CAP.</b>  | 4 - 5 kg            |



for installation video please scan barcode



**Lift Up Fitting**

|                     |                                  |
|---------------------|----------------------------------|
| <b>PRODUCT CODE</b> | SSFL -126                        |
| <b>DESCRIPTION</b>  | Use for Single Door (Soft Close) |
| <b>WEIGHT CAP.</b>  | 4.5 - 6 kg                       |



for installation video please scan barcode



|                     |                    |        |
|---------------------|--------------------|--------|
| <b>PRODUCT CODE</b> | SHK-80/120         |        |
| <b>DESCRIPTION</b>  | Gas Spring for Bed |        |
| <b>SIZE</b>         | 600mm              |        |
| <b>WEIGHT CAP.</b>  | 80 kg              | 120 kg |



|                     |            |  |
|---------------------|------------|--|
| <b>PRODUCT CODE</b> | SHK-175    |  |
| <b>DESCRIPTION</b>  | Gas Spring |  |
| <b>SIZE</b>         | 335mm      |  |
| <b>WEIGHT CAP.</b>  | 35 kg      |  |



|                     |                       |  |
|---------------------|-----------------------|--|
| <b>PRODUCT CODE</b> | SHK-167               |  |
| <b>DESCRIPTION</b>  | Gas Spring            |  |
| <b>WEIGHT CAP.</b>  | 5kg, 10kg, 15kg, 20kg |  |



|                     |                       |  |
|---------------------|-----------------------|--|
| <b>PRODUCT CODE</b> | SHK-150               |  |
| <b>DESCRIPTION</b>  | Gas Spring            |  |
| <b>WEIGHT CAP.</b>  | 5kg, 10kg, 15kg, 20kg |  |



|                     |                       |  |
|---------------------|-----------------------|--|
| <b>PRODUCT CODE</b> | SHK-155               |  |
| <b>DESCRIPTION</b>  | Soft Close Gas Spring |  |
| <b>WEIGHT CAP.</b>  | 5kg, 10kg, 15kg, 20kg |  |



|                     |               |  |
|---------------------|---------------|--|
| <b>PRODUCT CODE</b> | SHS -124      |  |
| <b>DESCRIPTION</b>  | Cabinet Stay  |  |
| <b>WEIGHT CAP.</b>  | 15 kg One Set |  |



|                     |                       |        |        |        |
|---------------------|-----------------------|--------|--------|--------|
| <b>PRODUCT CODE</b> | Bed Fitting 03        |        |        |        |
| <b>DESCRIPTION</b>  | Frame with Gas Spring |        |        |        |
| <b>SIZE</b>         | 1.5 mtr.              |        |        |        |
| <b>WEIGHT CAP.</b>  | 125 kg                | 150 kg | 175 kg | 200 kg |



|                     |               |  |
|---------------------|---------------|--|
| <b>PRODUCT CODE</b> | SHS -123      |  |
| <b>DESCRIPTION</b>  | Cabinet Stay  |  |
| <b>WEIGHT CAP.</b>  | 15 kg One Set |  |



|                     |                        |  |
|---------------------|------------------------|--|
| <b>PRODUCT NAME</b> | Soft Close Dampener    |  |
| <b>DESCRIPTION</b>  | For Telescopic Channel |  |



|                     |                          |  |
|---------------------|--------------------------|--|
| <b>PRODUCT CODE</b> | SPO-131                  |  |
| <b>DESCRIPTION</b>  | Push to Open with Magnet |  |



|                     |               |
|---------------------|---------------|
| <b>PRODUCT CODE</b> | SFL-113       |
| <b>DESCRIPTION</b>  | Furniture Leg |
| <b>MATERIAL</b>     | Aluminium     |
| <b>FINISH</b>       | Chrome        |
| <b>SIZE</b>         | 3" 4" 6"      |



|                     |               |
|---------------------|---------------|
| <b>PRODUCT CODE</b> | SFL-114       |
| <b>DESCRIPTION</b>  | Furniture Leg |
| <b>MATERIAL</b>     | Aluminium     |
| <b>FINISH</b>       | Chrome        |
| <b>SIZE</b>         | 3" 4" 6"      |



|                     |                          |
|---------------------|--------------------------|
| <b>PRODUCT CODE</b> | SFL-118                  |
| <b>DESCRIPTION</b>  | Furniture Leg            |
| <b>MATERIAL</b>     | Aluminium                |
| <b>FINISH</b>       | Blk+Gold PVD, RG PVD+Blk |
| <b>SIZE</b>         | 100mm 150mm 200mm        |



|                     |                                       |
|---------------------|---------------------------------------|
| <b>PRODUCT CODE</b> | SFL-115                               |
| <b>DESCRIPTION</b>  | Furniture Leg, Height : 50mm          |
| <b>MATERIAL</b>     | PVC+SS 304                            |
| <b>FINISH</b>       | Chrome PVD Rose Gold PVD Black Chrome |

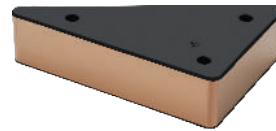

|                     |                                       |
|---------------------|---------------------------------------|
| <b>PRODUCT CODE</b> | SFL-115                               |
| <b>DESCRIPTION</b>  | L - Type Furniture Leg, Height : 50mm |
| <b>MATERIAL</b>     | PVC+SS 304                            |
| <b>FINISH</b>       | Chrome PVD Rose Gold PVD Black Chrome |



|                     |   |
|---------------------|---|
| <b>PRODUCT CODE</b> | SFL-116                                     |
| <b>DESCRIPTION</b>  | Furniture Leg, Height : 100mm               |
| <b>MATERIAL</b>     | Zinc  |
| <b>FINISH</b>       | SS Matt + CP Black Matt + Gold RG Matt + RG |



|                     |                               |
|---------------------|-------------------------------|
| <b>PRODUCT CODE</b> | SFL-117                       |
| <b>DESCRIPTION</b>  | Furniture Leg                 |
| <b>MATERIAL</b>     | PVC+SS 304                    |
| <b>SIZE</b>         | 2", 3", 4"                    |
| <b>FINISH</b>       | Chrome PVD Rose Gold PVD Gold |



|                     |                        |
|---------------------|------------------------|
| <b>PRODUCT CODE</b> | SMDS-01                |
| <b>DESCRIPTION</b>  | Magnet Door Stopper    |
| <b>MATERIAL</b>     | Zinc                   |
| <b>FINISH</b>       | SS, Antique, Matt Grey |



|                     |                        |
|---------------------|------------------------|
| <b>PRODUCT CODE</b> | SMDS-02                |
| <b>DESCRIPTION</b>  | Magnet Door Stopper    |
| <b>MATERIAL</b>     | Zinc                   |
| <b>FINISH</b>       | SS, Antique, Matt Grey |



|                     |                 |
|---------------------|-----------------|
| <b>PRODUCT NAME</b> | Indicating Bolt |
| <b>MATERIAL</b>     | Zinc            |
| <b>FINISH</b>       | Satin Nickle    |



|                     |                |
|---------------------|----------------|
| <b>PRODUCT NAME</b> | Baby Latch Big |
| <b>MATERIAL</b>     | Zinc           |
| <b>FINISH</b>       | Satin Nickle   |



|                     |                     |
|---------------------|---------------------|
| <b>PRODUCT CODE</b> | SCM-134             |
| <b>DESCRIPTION</b>  | Round Cable Manager |
| <b>MATERIAL</b>     | Zinc                |
| <b>FINISH</b>       | BSN                 |



|                     |                      |            |
|---------------------|----------------------|------------|
| <b>PRODUCT CODE</b> | SCM-132              | 80 x 80mm  |
| <b>PRODUCT CODE</b> | SCM-133              | 80 x 150mm |
| <b>DESCRIPTION</b>  | Square Cable Manager |            |
| <b>MATERIAL</b>     | Aluminium            |            |
| <b>FINISH</b>       | BSN                  |            |



|                     |             |
|---------------------|-------------|
| <b>PRODUCT CODE</b> | D - Stopper |
| <b>FINISH</b>       | BSN         |
| <b>MATERIAL</b>     | Zinc        |



|                     |                        |          |          |          |
|---------------------|------------------------|----------|----------|----------|
| <b>PRODUCT CODE</b> | SAVF                   |          |          |          |
| <b>DESCRIPTION</b>  | Ventilation Frame      |          |          |          |
| <b>MATERIAL</b>     | Aluminum               |          |          |          |
| <b>FINISH</b>       | Alu., SS Brus., Chrome |          |          |          |
| <b>SIZE (MM)</b>    | 80 x 150               | 80 x 200 | 80 x 300 | 80 x 400 |



|                     |             |       |
|---------------------|-------------|-------|
| <b>PRODUCT NAME</b> | Window Seal |       |
| <b>SIZE</b>         | 6mtr.       |       |
| <b>FINISH</b>       | White       | Brown |



|                     |                  |
|---------------------|------------------|
| <b>PRODUCT CODE</b> | Brush Seal       |
| <b>DESCRIPTION</b>  | with 3M Tape     |
| <b>SIZE</b>         | 7 x 8mm (10mtr.) |
| <b>FINISH</b>       | Grey             |





|                     |                        |
|---------------------|------------------------|
| <b>PRODUCT CODE</b> | SDV-10                 |
| <b>DESCRIPTION</b>  | Door Thickness 35-60mm |
| <b>FINISH</b>       | Satin Nickel, Antique  |



|                     |                        |
|---------------------|------------------------|
| <b>PRODUCT CODE</b> | SDV-20                 |
| <b>DESCRIPTION</b>  | Door Thickness 35-60mm |
| <b>FINISH</b>       | Satin Nickel, Antique  |



|                     |                    |
|---------------------|--------------------|
| <b>PRODUCT CODE</b> | SPB-19/25          |
| <b>DESCRIPTION</b>  | Round Pipe Bracket |
| <b>SIZE</b>         | 19mm      25mm     |
| <b>FINISH</b>       | Chrome             |



|                     |              |
|---------------------|--------------|
| <b>PRODUCT CODE</b> | SB-03        |
| <b>DESCRIPTION</b>  | Shelf Button |
| <b>SIZE</b>         | Chrome       |



|                     |              |
|---------------------|--------------|
| <b>PRODUCT CODE</b> | SB-04        |
| <b>DESCRIPTION</b>  | Shelf Button |
| <b>SIZE</b>         | Chrome       |



|                     |              |
|---------------------|--------------|
| <b>PRODUCT CODE</b> | SB-08        |
| <b>DESCRIPTION</b>  | Shelf Button |
| <b>SIZE</b>         | Chrome       |



|                     |                   |
|---------------------|-------------------|
| <b>PRODUCT CODE</b> | SOB-135           |
| <b>DESCRIPTION</b>  | Oval Pipe Bracket |
| <b>SIZE</b>         | Chrome            |



|                     |                   |
|---------------------|-------------------|
| <b>PRODUCT CODE</b> | SOB-140           |
| <b>DESCRIPTION</b>  | Oval Pipe Bracket |
| <b>SIZE</b>         | Chrome            |



VISION



PLAN



INNOVATION



TEAM



SERVICE



QUALITY



[www.starrs.in](http://www.starrs.in)  
[sales.starrs@gmail.com](mailto:sales.starrs@gmail.com)



for download catalog  
please scan barcode