

Furniture Fittings & Architectural Hardware Price List*

November, 2020

Technik für Möbel





Hettich Forum at Kirchlengern, Germany



Hettich Manufacturing Plant at Vadodara, India



Hettich Manufacturing Plant at Indore, India

The company's origins date back to 1888, when Karl Hettich began making the new clock component he had invented. By 1930, his descendants had diversified into furniture fittings, setting up production in East Westphalia – a centre of the German furniture industry. Today, Hettich, still family owned, has become an industry leader with a worldwide reputation.

We're one of the world's largest manufacturers of high-quality furniture fittings, with over 6,700 employees in more than 100 countries. The company's success has been built on four enduring values: quality, innovation, close cooperation with customers and absolute reliability.

We work to inspire our customers with our ideas and our passion.

Awarded by experts. Praised by customers.



Sensys hinge



**ViZard by ambigence
Flap fitting**



**TopLine XL
sliding door system**



Inline S



SlideLine M



WingLine L



**InnoTech Atira
drawer system**



ArciTech drawer system



CargoTech



ComfortSpin rotating shelf



**ComfortSwing lifting system
for dishwasher's bottom rack**



Easys for refrigerators





Quality

Hettich products stand for high quality. Once assembled, our fittings function perfectly day in, day out. High quality products and processes confirm our sense of value, our self confidence and our image. The way to the quality goal for each one of us is to cultivate an intense quality awareness.

Innovation

The right balance of continuity and innovation generates trust in the Hettich brand. We offer timely, high-value solutions for today's furniture; at the same time, we identify and shape the trends of tomorrow. We review and improve existing solutions ready for the future. Driving innovation is our capacity for looking at things from new angles.

Closeness to customers

For us closeness to customers implies sharpened awareness, attention to detail, a grasp of complex challenges, and efficiency in production and logistics. We know our customers. We're there when our customers need us! The keynote of our partnership with our customers is direct, person-to-person communication.

Reliability

Quality, innovation, closeness to customers – they're nothing without reliability! Reliability encompasses the durability of our products and the reliability of Hettich people – each and every one of us. The solid basis for reliability is robust and stable processes.



Warranty

For Warranty please refer to website.
www.hettich.com/in

* Refer Website



FREE 

Design Services
incl. bill of qty.

Free Design Service:

Looking for Designs to liven up your Living Room, Bedroom, Bathroom & Kitchen? A dedicated team of highly qualified Interior Designers is at your service to provide customized design solution to suit every taste and budget at zero cost to you.

Free Consultation at your Doorstep:

Looking for perfect Furniture Fittings solution? A dedicated team of highly qualified professionals is at your service to provide the perfect furniture fittings solution to suit your need and budget at zero cost to you.

Hettich Customer Care Service:

In today's fast paced and technologically advanced era, most of the organizations succumb to the pressure of staying ahead in the competition and often, end up neglecting the most critical aspect of business i.e. customers. Hettich, being a customer centric organization, is very sensitive towards this tendency; hence, we constantly try to provide the best and quality driven products and services.

For Enquiry & Customer Services

Toll Free : 1800 209 2096 (office hours)
 Email: sales_enquiry@in.hettich.com
customer_services@in.hettich.com
www.hettich.com

INDEX



Furniture Fittings	07
Hinges	08-14
Flap Fittings	15-17
Sliding & Folding Systems	18-34
Drawer Runners (Quadro, KA & FR)	35-38
Drawer System: MultiTech	39
Drawer System: InnoTech	40-49
Drawer System: ArciTech	50-69
Cargo Series	70
CargoTech	71-72
CargoPlus	73
CargoTech M	74
Kitchen Accessories	75-78
Wardrobe Accessories	79-80
Connecting Fitting & Locks	81-85
Handles	86-89
Aluminium Profiles	90-92
Screws	93
Lights	94-97
Cube Shelving System	98-100

Architectural Hardware	101
Hinge Technology	102-103
Door Closer	104-106
Mortise Locking Solution	107-118
Panic Solution	119
ProLock Infinity Locking Solutions	120-121
Cylindrical Knobs & Handle Sets	122
Floor Springs	123
Glass Patch Fittings	124-125
Glass Sliding	125
Pull Handles	126
Shower Fittings	126-128
Shower Header Bar & Connecting Fittings	129-130
Shower Seals	131
Door Seals	132
Door Accessories	133-135
Appendix	136-151

* Company reserves the right to change the product's prices at any time without further notice.





SlideOn



Sensys Obsidian Black



Intermat



Onsys



Product	Article No.	SAP	Item Description	Qty.	Unit	PU	MRP	HS Code
Slide On Hinges								
	Slide On 2333 Hinge - T42 for 14-25 mm thick doors; Opening angle 95°							
	9242867	9242867	Base 12.5 (Crank 0°) with Mounting Plate (D 1.5 mm)	1	Pair	100	94	83021090
	9242868	9242868	Base 5 (Crank 9.5°) with Mounting Plate (D 1.5 mm)	1	Pair	100	99	83021090
	9242869	9242869	Base -1.5 (Crank 16°) with Mounting Plate (D 1.5 mm)	1	Pair	100	104	83021090
	9242870	9242870	Base 12.5 (Crank 0°) with Mounting Plate (D 1.5 mm) & with Dampener	1	Pair	100	247	83021090
	Accessories for Slide On Hinge							
	9042758	9042758	Dampener for Hinge Cup overlay doors	1	Pc	100	153	83024200
Intermat Hinges								
	Intermat 9943 Hinge - TH42 for 15-25 mm thick doors; Opening angle 110°							
	9242871	9242871	Base 12.5 (Crank 0°) with Mounting Plate (D 0 mm)	1	Pair	100	229	83021090
	9242872	9242872	Base 3 (Crank 9.5°) with Mounting Plate (D 0 mm)	1	Pair	100	252	83021090
	9242873	9242873	Base -3.5 (Crank 16°) with Mounting Plate (D 0 mm)	1	Pair	100	258	83021090
	Intermat 9936 Hinge - TH42 for 14-32 mm thick doors; Opening angle 95°							
	9242874	9242874	Base 12.5 (Crank 0°) with Mounting Plate (D 0 mm)	1	Pair	100	241	83021090
	9242876	9242876	Base 3 (Crank 9.5°) with Mounting Plate (D 0 mm)	1	Pair	100	265	83021090
	9242877	9242877	Base -3.5 (Crank 16°) with Mounting Plate (D 0 mm)	1	Pair	100	271	83021090
	Intermat 9935 Hinge - TH22/L for 16-43 mm thick doors; Opening angle 95°							
	9242878	9242878	Base 18 (Crank -5°) with Mounting Plate (D 0 mm)	1	Pair	100	778	83021090
	9242883	9242883	Base 8 (Crank 5°) with Mounting Plate (D 0 mm)	1	Pair	100	802	83021090
	9242885	9242885	Base -3 (Crank 16°) with Mounting Plate (D 0 mm)	1	Pair	100	807	83021090
	Intermat 9956 Hinge - TH42 16-24 mm thick doors; Opening angle 165°							
	9242890	9242890	Base 12.5 (Crank 0°) with Intermat Mounting plate	1	Pair	50	809	83021090
	Intermat 9930 Hinge- TH52 16-21 mm thick doors; Opening angle 50/65°							
	9243042	9243042	Corner unit folding door with Intermat Mounting Plate (D 0 mm); cup in sensys design	1	Pair	100	761	83021090
	9242888	9242888	Corner unit folding door with Intermat Mounting Plate (D 0 mm); cup in Intermat design	1	Pair	100	741	83021090

Product	Article No.	SAP	Item Description	Qty.	Unit	PU	MRP	HS Code
Intermat 9936 Hinge W90 - TH42 14-28 mm thick doors; face angle 90°, Opening Angle 95°								
	9242895	9242895	Blind corner (W 90°)	1	Pair	100	722	83021090
Intermat 9936 Hinge TA22 19 mm Aluminium Profile doors; Opening angle 95°								
	9242896	9242896	Base 13.5 (Crank 0°) with Mounting Plate (D 0 mm)	1	Pair	10	443	83021090
Accessories for Intermat Hinge								
	72983	1071605	Intermat Cross Mounting Plate (System 9000) (D 0 mm)	1	Pc	100	16	83021000
	9071575	9091575	Sensys Cross Mounting Plate (System 8099) (D 0 mm)	1	Pc	100	24	83021000
Push to Open (P20) Opening System Screw on								
	9051925	9051925	P20 Universal Maxi	1	Set	25	415	39263000
	9089611	9089611	Push to open Pin Strong for screwing on	1	Set	25	637	39269097



Product	Article No.	SAP	Item Description	Qty.	Unit	PU	MRP	HS Code
Onsys Hinge								
	Onsys 4447i Hinge - TH42 for 14-25 mm thick doors; Opening angle 105°							
	9281432	9281432	Onsys Hinge - 25 mm - 0 Crank with mounting plate and cover caps	1	Pair	50	342	83021090
	9281434	9281434	Onsys Hinge - 25 mm - 9.5 Crank with mounting plate and cover caps	1	Pair	50	376	83021090
	9281436	9281436	Onsys Hinge - 25 mm - 16 Crank with mounting plate and cover caps	1	Pair	50	410	83021090
Sensys Hinge								
	Sensys 8645i Hinge - TH52 for 15-24 mm thick doors; Opening angle 110°							
	9242917	9242917	Base 12.5 (Crank 0°) with Mounting Plate (D 0 mm)	1	Pair	100	511	83021090
	9242919	9242919	Base 3 (Crank 9.5°) with Mounting Plate (D 0 mm)	1	Pair	100	545	83021090
	9242921	9242921	Base -4 (Crank 16°) with Mounting Plate (D 0 mm)	1	Pair	100	579	83021090
	Sensys 8631i Hinge - TH52 for 15-32 mm thick doors; Opening angle 95°							
	9242902	9242902	Base 12.5 (Crank 0°) with Mounting Plate (D 0 mm)	1	Pair	100	551	83021090
	9242905	9242905	Base 3 (Crank 9.5°) with Mounting Plate (D 0 mm)	1	Pair	100	585	83021090
	9242906	9242906	Base-4 (Crank 16°) with Mounting Plate (D 0 mm)	1	Pair	100	619	83021090
	Sensys 8657i Hinge - TH52 for 15-32 mm thick doors; Opening angle 165° (Zero Protrusion Hinge)							
	9243040	9243040	Base 12.5 (Crank 0°) with Mounting Plate (D 0 mm)	1	Pair	50	1,255	83021090
	Sensys 8638i Hinge - TA32 for 19 mm Aluminium Profile; Opening angle 95°							
	9243057	9243057	Base 12.5 (Crank 0°) with Mounting Plate (D 0 mm)	1	Pair	50	833	83021090
	Sensys 8639i W90 Hinge - TH52 for 90° Face Angle Application; Opening angle 95°							
	9243043	9243043	Base 4 (Crank 4) with Mounting Plate	1	Pair	50	1,217	83021090
	Accessories of Sensys Hinge							
	9199822	9199822	Sensys Cover Cap "Made in Germany"	1	Pc	50	13	83024200
	9082614	9082614	Sensys Cover Cap for Hinge Cup T52/53	1	Pc	50	16	83024200
	9071575	9091575	Sensys Mount Plate D 0	1	Pc	100	24	83021000
	9088242	9088242	Sensys Press-in Linear Mount Plate D 0.5	1	Pc	50	93	83021000
	9046472	9046472	Dampener for Overlay Hinges - Screw On	1	Pc	50	310	83024200
	46695	9246420	Door Buffer Self-Adhesive	1000	Pc	1000	6,461	39269097
	1001097	1001097	T43 Hinge Screws (45169a)	1	Pc	5000	3	73181558
1058613	1058613	T43 Hinge Sockets 10 mm Dia	1	Pc	10000	6	39269097	

Product	Article No.	SAP	Item Description	Qty.	Unit	PU	MRP	HS Code
Obsidian Black Sensys Hinge								
	Obsidian Black Sensys 8645i Hinge - TH52 for 15-24 mm thick doors; Opening angle 110°							
	9091738	9091738	Base 12.5 (Crank 0°)	1	Pc	50	346	83021000
	9091739	9091739	Base 3 (Crank 9.5°)	1	Pc	50	367	83021000
	9091740	9091740	Base -4 (Crank 16°) (Order mounting plate separately)	1	Pc	50	389	83021000
	Obsidian Black Sensys 8631i Hinge - TH52 for 15-32 mm thick doors; Opening angle 95°							
	9091753	9091753	Base 12.5 (Crank 0°)	1	Pc	50	369	83021000
	9091755	9091755	Base 3 (Crank 9.5°)	1	Pc	50	391	83021000
	9091756	9091756	Base-4 (Crank 16°) (Order mounting plate separately)	1	Pc	50	424	83021000
	Obsidian Black Sensys 8657i Hinge-TH52 for 15-32 mm thick doors; Opening angle 165°(Zero Protrusion Hinge)							
	9091767	9091767	Base 12.5 (Crank 0°) (Order mounting plate separately)	1	Pc	50	961	83021000
	Obsidian Black Sensys 8646i Hinge - TH52 for 10-16 mm Thin door; Opening angle 110°							
	9091761	9091761	Base 12.5 (Crank 0°)	1	Pc	50	513	83021000
	9091762	9091762	Base 3 (Crank 9.5°)	1	Pc	50	534	83021000
	9091763	9091763	Base-4 (Crank 16°) (Order mounting plate separately)	1	Pc	50	555	83021000
	Obsidian Black Sensys 8639i W90 Hinge - TH52 for 90° Face Angle Application; Opening angle 95°							
	9091748	9091748	Base 4 (Crank 4) (Order mounting plate separately)	1	Pc	50	729	83021000
	Accessories of Sensys Hinge							
	9091803	9091803	System 8099 Sensys Cross Mounting Plate with eccentric CAM D 0 mm in Black	1	Pc	50	84	83021000
	9091815	9091815	Sensys Screw-on Linear Mounting Plate with eccentric CAM D 0.5 in Black	1	Pc	50	134	83021000
	9091820	9091820	Sensys Cover Cap for Hinge Arm in Black	1	Pc	50	15	83024200
	9091822	9091822	Sensys Cover Cap for Hinge Cup T52/53 in Black	1	Pc	50	26	83024200

Product	Article No.	SAP	Item Description	Qty.	Unit	PU	MRP	HS Code
Assorted Hinges								
	Glass Door hinge Opening angle 105°							
	20870	9076437	Glass Door hinge ET 150 nickel matt for inset door	1	Pair	20	316	83021000
	20873	20873	Magnetic catch D7/GP9 black	1	Pc	20	149	85051100
	Butt Hinges SS 304							
	9287297	9287297	SS 304 (4" x 3" x 3) without screws - Bulk pack	1	Pair	100	825	83021000
	9287298	9287298	SS 304 (5" x 3" x 3) without screws - Bulk pack	1	Pair	100	1,025	83021000
	Centre Hinge for Folding Doors Opening angle 180°							
	1069932	1069932	Centre hinge 625	1	Pc	10	35	83021000



Product	Article No.	SAP	Item Description	Qty.	Unit	PU	MRP	HS Code
HIN – Ball Bearing Hinge: SS 304, EN 1935 Certified for 200,000 Cycle, 105 min Fire rated, 5 years Functional Warranty								
 <p>EN 1935 F</p>	HIN – Ball Bearing Hinge Satin Stainless Steel (SSS) Finish							
	9268610	9268610	SS 304 Hinge 4"x3"x3 Square Corner (Hole Pattern: C)	1	Pair	20	825	83021000
	9268384	9268384	SS 304 Hinge 4"x3"x3 Round Corner (Hole Pattern: C)	1	Pair	20	825	83021000
	9268631	9268631	SS 304 Hinge 5"x3"x3 Square Corner (Hole Pattern: Z)	1	Pair	20	1025	83021000
	9268632	9268632	SS 304 Hinge 5"x3"x3 Round Corner (Hole Pattern: Z)	1	Pair	20	1025	83021000
			(Supplied with screws)					
 <p>EN 1935 F</p>	HIN – Ball Bearing Hinge Polished Brass (PB) Finish							
	9268382	9268382	SS 304 Hinge 4"x3"x3 Square Corner (Hole Pattern: C)	1	Pair	20	925	83021000
	9268386	9268386	SS 304 Hinge 4"x3"x3 Round Corner (Hole Pattern: C)	1	Pair	20	925	83021000
	9268389	9268389	SS 304 Hinge 5"x3"x3 Square Corner (Hole Pattern: Z)	1	Pair	20	1150	83021000
	9268392	9268392	SS 304 Hinge 5"x3"x3 Round Corner (Hole Pattern: Z)	1	Pair	20	1150	83021000
			(Supplied with screws)					
 <p>EN 1935 F</p>	HIN – Ball Bearing Hinge Bright Chrome (CH) Finish							
	9268198	9268198	SS 304 Hinge 4"x3"x3 Square Corner (Hole Pattern: C)	1	Pair	20	925	83021000
	9268385	9268385	SS 304 Hinge 4"x3"x3 Round Corner (Hole Pattern: C)	1	Pair	20	925	83021000
	9268388	9268388	SS 304 Hinge 5"x3"x3 Square Corner (Hole Pattern: Z)	1	Pair	20	1150	83021000
	9268391	9268391	SS 304 Hinge 5"x3"x3 Round Corner (Hole Pattern: Z)	1	Pair	20	1150	83021000
			(Supplied with screws)					
 <p>EN 1935 F</p>	HIN – Ball Bearing Hinge Antique Brass (AB) Finish							
	9268383	9268383	SS 304 Hinge 4"x3"x3 Square Corner (Hole Pattern: C)	1	Pair	20	925	83021000
	9268387	9268387	SS 304 Hinge 4"x3"x3 Round Corner (Hole Pattern: C)	1	Pair	20	925	83021000
	9268390	9268390	SS 304 Hinge 5"x3"x3 Square Corner (Hole Pattern: Z)	1	Pair	20	1150	83021000
	9268393	9268393	SS 304 Hinge 5"x3"x3 Round Corner (Hole Pattern: Z)	1	Pair	20	1150	83021000
			(Supplied with screws)					

Flap Fittings

▶ HF / HK / HL / HS / FYL



Product	Article No.	SAP	Item Description	Qty.	Unit	PU	MRP	HS Code
---------	-------------	-----	------------------	------	------	----	-----	---------

Lift Ups & Flap Stays



Lift Advanced HF (Order Gas Spring Sets Separately)

9079605	9079605	Lift Advanced HF (Inside Carcass Height 440-550 mm)	1	Set	1	7,874	83024900
9079607	9079607	Lift Advanced HF (Inside Carcass Height 551-610 mm)	1	Set	1	7,874	83024900
9079610	9079610	Lift Advanced HF (Inside Carcass Height 611-700 mm)	1	Set	1	7,874	83024900
9079601	9079601	Lift Advanced HF 19mm Alu. Frame Adapter	1	Set	1	458	83024900

(Order Hinges Separately)

Gas Spring Sets for Lift Advanced HF

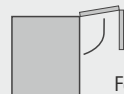

Folding flap fitting

Inside carcass height mm 450 - 550	Inside carcass height mm 551 - 610	Inside carcass height mm 611 - 700	Spring force N	Article No.	SAP	Unit	HS Code
4.4 - 5.8 kg	4.0 - 6.0 kg	-	300	9105888	9105888	Pc	83024200
5.1 - 6.6 kg	4.5 - 6.7 kg	3.8 - 5.8 kg	350	9105889	9105889	Pc	83024200
6.0 - 8.0 kg	5.3 - 7.6 kg	4.6 - 7.0 kg	400	9105890	9105890	Pc	83024200
6.8 - 9.2 kg	6.2 - 8.6 kg	5.9 - 8.0 kg	450	9105891	9105891	Pc	83024200
7.8 - 10.2 kg	7.0 - 9.3 kg	6.9 - 8.9 kg	500	9105892	9105892	Pc	94039010
8.9 - 11.2 kg	8.0 - 10.3 kg	8.0 - 9.9 kg	550	9105895	9105895	Pc	83024200
10.5 - 12.6 kg	9.1 - 11.4 kg	8.8 - 10.8 kg	600	9105896	9105896	Pc	83024200
12.2 - 14.2 kg	10.5 - 12.6 kg	10.1 - 12.0 kg	650	9105897	9105897	Pc	83024200
13.2 - 15.0 kg	11.7 - 13.6 kg	11.1 - 12.9 kg	700	9105898	9105898	Pc	83024200
13.8 - 15.4 kg	12.3 - 14.1 kg	11.6 - 13.5 kg	750	9105899	9105899	Pc	83024200
-	13.3 - 14.6 kg	12.6 - 14.4 kg	800	9105900	9105900	Pc	83024200
-	-	13.4 - 15.2 kg	850	9105901	9105901	Pc	83024200



Lift Advanced HK (Order Gas Spring Sets Separately)

9079603	9079603	Lift Advanced HK (Inside Carcass Height 276 - 720 mm)	1	Set	1	6,296	83024900
9079709	9079709	Lift Advanced HK 19mm Alu. Frame Adapter	1	Set	1	616	83024200

(Order Hinges Separately)

Gas Spring Sets for Lift Advanced HK

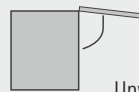

Upward opening flap fitting

Inside carcass height mm 276 - 360	Inside carcass height mm 361 - 480	Inside carcass height mm 481 - 540	Inside carcass height mm 541 - 600	Inside carcass height mm 601 - 720	Spring force N	Article No.	SAP	Unit	HS Code
2.1 - 4.7 kg *	2.0 - 3.8 kg	-	-	-	150	9105884	9105884	Pc	83024200
4.1 - 7.0 kg *	3.3 - 5.4 kg	2.4 - 4.9 kg	-	-	200	9105885	9105885	Pc	83024200
6.1 - 8.9 kg *	4.5 - 6.3 kg	3.8 - 6.2 kg	3.8 - 5.6 kg	3.8 - 5.0 kg	250	9105886	9105886	Pc	83024200
7.8 - 10.7 kg *	5.7 - 7.9 kg	5.2 - 7.6 kg	4.9 - 6.7 kg	4.4 - 5.9 kg	300	9105888	9105888	Pc	83024200
9.7 - 12.4 kg *	7.1 - 9.3 kg	6.6 - 9.0 kg	6.1 - 7.7 kg	5.4 - 6.8 kg	350	9105889	9105889	Pc	83024200
11.5 - 14.3 kg	8.6 - 10.7 kg	8.1 - 10.3 kg	7.2 - 8.8 kg	6.3 - 7.8 kg	400	9105890	9105890	Pc	83024200
13.3 - 16.0 kg	10.2 - 12.1 kg	9.7 - 11.6 kg	8.4 - 10.0 kg	7.3 - 8.7 kg	450	9105891	9105891	Pc	94039010
15.2 - 17.9 kg	11.7 - 13.4 kg	11.0 - 12.8 kg	9.6 - 11.0 kg	8.2 - 9.6 kg	500	9105892	9105892	Pc	83024200
-	12.9 - 14.3 kg	12.4 - 14.1 kg	10.7 - 12.2 kg	9.1 - 10.4 kg	550	9105895	9105895	Pc	83024200
-	14.2 - 15.5 kg	13.7 - 15.4 kg	12.0 - 13.2 kg	10.1 - 11.4 kg	600	9105896	9105896	Pc	83024200
-	15.4 - 16.8 kg	15.0 - 16.7 kg	13.1 - 14.3 kg	11.1 - 12.4 kg	650	9105897	9105897	Pc	83024200

Flap Fittings

▶ HF / HK / HL / HS / FYL



Product	Article No.	SAP	Item Description	Qty.	Unit	PU	MRP	HS Code
	Lift Advanced HL (Order Gas Spring Sets Separately)							
	9079595	9079595	Lift Advanced HL (Inside Carcass Height 277-312 mm)	1	Set	1	7,874	83024900
	9079597	9079597	Lift Advanced HL (Inside Carcass Height 313-342 mm)	1	Set	1	7,874	83024900
	9079598	9079598	Lift Advanced HL (Inside Carcass Height 343-372 mm)	1	Set	1	7,874	83024900
	9079599	9079599	Lift Advanced HL (Inside Carcass Height 373-402 mm)	1	Set	1	7,874	83024900
	9079600	9079600	Lift Advanced HL (Inside Carcass Height 403-462 mm)	1	Set	1	7,874	83024900
	9079653	9079653	Lift Advanced Shortenable Rod 600	1	Set	1	931	83024900
	9079658	9079658	Lift Advanced Shortenable Rod 1200	1	Set	1	1,563	83024900
	9079664	9079664	Lift Advanced Shortenable Rod 1800	1	Set	1	2,194	83024900
	9079601	9079601	19mm Alu. Frame Adapter (Order Hinges Separately)	1	Set	1	458	83024900

Gas Spring Sets for Lift Advanced HL



Flap lift fitting

Inside carcass height mm 277 - 312	Inside carcass height mm 313 - 342	Inside carcass height mm 343 - 372	Inside carcass height mm 373 - 402	Inside carcass height mm 403 - 462	Spring force N	Article No.	SAP	Unit	HS Code
2.1 - 3.8 kg	2.3 - 3.8 kg	-	-	-	150	9105884	9105884	Pc	83024200
3.8 - 5.4 kg	3.6 - 5.3 kg	2.1 - 4.8 kg	1.7 - 3.8 kg	-	200	9105885	9105885	Pc	83024900
5.6 - 7.1 kg	5.2 - 7.1 kg	3.3 - 6.0 kg	2.6 - 5.0 kg	3.2 - 4.9 kg	250	9105886	9105886	Pc	83024900
7.3 - 8.8 kg	6.5 - 8.7 kg	4.3 - 7.2 kg	3.8 - 6.3 kg	4.4 - 5.9 kg	300	9105888	9105888	Pc	83024900
8.9 - 10.5 kg	7.9 - 10.2 kg	5.5 - 8.6 kg	4.9 - 7.5 kg	5.4 - 6.8 kg	350	9105889	9105889	Pc	83024900
10.6 - 12.1 kg	9.1 - 11.7 kg	6.6 - 9.7 kg	6.0 - 8.7 kg	6.3 - 7.8 kg	400	9105890	9105890	Pc	83024900
-	10.5 - 13.2 kg	7.8 - 10.9 kg	7.1 - 9.9 kg	7.3 - 8.7 kg	450	9105891	9105891	Pc	83024900
-	11.6 - 14.7 kg	8.9 - 12.2 kg	8.2 - 11.1 kg	8.2 - 9.6 kg	500	9105892	9105892	Pc	83024900
-	12.8 - 16.2 kg	10.0 - 13.4 kg	9.3 - 12.4 kg	9.1 - 10.4 kg	550	9105895	9105895	Pc	83024900
-	14.2 - 17.6 kg	11.2 - 14.6 kg	10.5 - 13.6 kg	10.1 - 11.4 kg	600	9105896	9105896	Pc	83024900
-	-	12.5 - 15.9 kg	11.7 - 14.9 kg	11.1 - 12.4 kg	650	9105897	9105897	Pc	83024900

	Lift Advanced HS (Order Gas Spring Sets Separately)							
	9079617	9079617	Lift Advanced HS (Inside Carcass Height 372-688 mm)	1	Set	1	7,874	83024200
	9079653	9079653	Lift Advanced Shortenable Rod 600	1	Set	1	931	83024900
	9079658	9079658	Lift Advanced Shortenable Rod 1200	1	Set	1	1,563	83024900
	9079664	9079664	Lift Advanced Shortenable Rod 1800	1	Set	1	2,194	83024900
	9079601	9079601	19mm Alu. Frame Adapter (Order Hinges Separately)	1	Set	1	458	83024900

Gas Spring Sets for Lift Advanced HS



Lift up flap fitting

Inside carcass height mm 372 - 408	Inside carcass height mm 409 - 508	Inside carcass height mm 509 - 568	Inside carcass height mm 569 - 688	Spring force N	Article No.	SAP	Unit	HS Code
3.0 - 4.4 kg	3.2 - 4.3 kg	2.5 - 3.9 kg	-	200	9105885	9105885	Pc	83024200
4.0 - 5.4 kg	4.2 - 5.4 kg	3.4 - 5.2 kg	3.2 - 4.8 kg	250	9105886	9105886	Pc	83024200
5.3 - 6.7 kg	5.2 - 6.5 kg	4.4 - 6.4 kg	4.0 - 6.1 kg	300	9105888	9105888	Pc	83024200
6.3 - 7.9 kg	6.3 - 7.4 kg	5.4 - 7.4 kg	4.9 - 7.1 kg	350	9105889	9105889	Pc	83024200
7.7 - 9.1 kg	7.3 - 8.6 kg	6.5 - 8.4 kg	5.8 - 8.2 kg	400	9105890	9105890	Pc	83024200
8.8 - 10.3 kg	8.4 - 9.9 kg	7.5 - 9.5 kg	6.8 - 9.1 kg	450	9105891	9105891	Pc	83024200
10.0 - 11.5 kg	9.4 - 10.9 kg	8.6 - 10.5 kg	7.7 - 10.0 kg	500	9105892	9105892	Pc	94039010
11.0 - 12.6 kg	10.5 - 12.1 kg	9.6 - 11.6 kg	8.6 - 11.6 kg	550	9105895	9105895	Pc	83024200
12.1 - 13.8 kg	11.6 - 13.2 kg	10.7 - 12.6 kg	9.6 - 12.6 kg	600	9105896	9105896	Pc	83024200
13.3 - 14.9 kg	12.6 - 14.2 kg	11.7 - 13.7 kg	10.5 - 13.5 kg	650	9105897	9105897	Pc	83024200
-	13.6 - 15.3 kg	12.8 - 14.7 kg	11.4 - 14.3 kg	700	9105898	9105898	Pc	83024200

Flap Fittings

▶ HF / HK / HL / HS / FYL







Product	Article No.	SAP	Item Description	Qty.	Unit	PU	MRP	HS Code
	Gas Spring sets for Advanced Lift-Up (HF, HK, HL & HS) (Order 2 pieces with 1 set of Advanced Lift-Up)							
	9105884	9105884	Spring Force 150N	1	Pc	1	1,825	83024200
	9105885	9105885	Spring Force 200N	1	Pc	1	1,825	83024200
	9105886	9105886	Spring Force 250N	1	Pc	1	1,501	83024200
	9105888	9105888	Spring Force 300N	1	Pc	1	1,501	83024200
	9105889	9105889	Spring Force 350N	1	Pc	1	1,501	83024200
	9105890	9105890	Spring Force 400N	1	Pc	1	1,501	83024200
	9105891	9105891	Spring Force 450N	1	Pc	1	1,501	83024200
	9105892	9105892	Spring Force 500N	1	Pc	1	1,501	94039010
	9105895	9105895	Spring Force 550N	1	Pc	1	1,501	83024200
	9105896	9105896	Spring Force 600N	1	Pc	1	1,501	83024200
	9105897	9105897	Spring Force 650N	1	Pc	1	1,501	83024200
	9105898	9105898	Spring Force 700N	1	Pc	1	1,825	83024200
	9105899	9105899	Spring Force 750N	1	Pc	1	2,250	83024200
	9105900	9105900	Spring Force 800N	1	Pc	1	2,250	83024200
	9105901	9105901	Spring Force 850N	1	Pc	1	2,250	83024200
	Lift Up FLY (Opening angle 90°) (Order Hinges Separately)							
	9111155	9111155	Grey 450N	1	Pc	1	6,280	83024200
	Lift Up - Top Box Lift 90 (Order Hinges Separately)							
	10921 L	1077875	Flap Lift Exact 90 (4.6 kg) Left	1	Pc	30	465	83024200
	10921 R	1077876	Flap Lift Exact 90 (4.6 kg) Right	1	Pc	30	465	83024200
	Flap Stay KLS 30 (Order Hinge Separately)							
	16179	16179	KLS 30 Flap Support (4kg weight carrying capacity with 2 fittings ; Max Flap Dimensions: Width 600 mm Et Height 500 mm)	1	Pc	10	1,337	83024200
	Flap Stay Lift Basic (Order Hinge Separately)							
	9079593	9079593	Lift Basic Flap Stay (3.2kg weight carrying capacity with 2 fittings ; Max Flap Dimensions: Width 600 mm Et Height 400 mm)	1	Pc	10	314	83024200
	Klassik D with magnetic stay close function							
	21579	21579	Klassik D Magnetic 4 kg Left	1	Pc	10	906	85051100
	21700	21700	Klassik D Magnetic 4 kg Right	1	Pc	10	906	85051100
	KH Flap Stay							
	13233	13233	KH L200	1	Pc	10	146	83024200
	40242	9073503	Markant 11 Flap Hinge 35 mm	1	Pc	20	239	83021000

Sliding & Folding Systems



Product	Article No.	SAP	Item Description	Qty.	Unit	PU	MRP	HS Code
Top Running & Flush Fitted Wardrobe Door Sliding Fittings								
InLineXL								
	InLine XL - Weight 60 Kg per Door; Max. Dimensions: Height- 2600 mm & Width - 1799 mm (Pre-order Form required for ordering)							
	9148180	9148180	Door width 750 -819 mm (max. door height 2000 mm)	1	Set	1	1,09,846	83024200
	9148201	9148201	Door width 820 -909 mm (max. door height 2000 mm)	1	Set	1	1,09,833	83024200
	9148202	9148202	Door width 910 -1044 mm (max. door height 2200 mm)	1	Set	1	1,09,887	83024200
	9148203	9148203	Door width 1045 -1199 mm (max. door height 2200 mm)	1	Set	1	1,00,971	83024200
	9148204	9148204	Door width 1200 -1299 mm (max. door height 2400 mm)	1	Set	1	1,04,127	83024200
	9148205	9148205	Door width 1300 -1499 mm (max. door height 2400 mm)	1	Set	1	1,07,283	83024200
	9148206	9148206	Door width 1500 -1599 mm (max. door height 2600 mm)	1	Set	1	1,10,439	83024200
	9116581	9116581	Door width 1600 -1799 mm (max. door height 2600 mm)	1	Set	1	1,13,595	83024200







Top Running & Overlay & Inset Wardrobe Door Sliding Fittings								
TopLineXL								
	TopLine XL 2 Door Advanced - Weight 80 Kg per Door with Soft Closing & Soft Opening; Max. Door Dimensions: Height-2600 mm & Width- (1500) 2000 mm							
	9181742	9181742	Frontmost Door Set for 19 mm max. door thickness EB 30	1	Set	1	12,611	83024200
	9183613	9183613	Frontmost Door Set for 22 mm max. door thickness EB 33	1	Set	1	12,611	83024200
	9183615	9183615	Frontmost Door Set for 28 mm max. door thickness EB 39	1	Set	1	12,611	83024200
	9183616	9183616	Frontmost Door Set for 40 mm max. door thickness EB 51	1	Set	1	19,591	83024200
	9181744	9181744	Rearmost Door Set Left side	1	Set	1	7,571	83024200
	9169548	9169548	Soft Opening & Closing System	1	Set	1	9,928	39263000
	9135004	9135004	4000 mm Predrilled Runner profile , Guide Profile and Cover Profile	1	Set	1	23,516	83024200
	9135002	9135002	3000 mm Predrilled Runner profile , Guide Profile and Cover Profile	1	Set	1	18,637	83024200
	TopLine XL 3 Door Advanced - Weight 80 Kg per Door with Soft Closing & Soft Opening; Max. Door Dimensions: Height-2600 mm & Width-2000 mm							
	9181742	9181742	Frontmost Door Set for 19 mm max. door thickness EB 30	1	Set	1	12,611	83024200
	9183613	9183613	Frontmost Door Set for 22 mm max. door thickness EB 33	1	Set	1	12,611	83024200
	9183615	9183615	Frontmost Door Set for 28 mm max. door thickness EB 39	1	Set	1	12,611	83024200
	9183616	9183616	Frontmost Door Set for 40 mm max. door thickness EB 51	1	Set	1	19,951	83024200
	9181744	9181744	Rearmost Door Set Left side for Doors	1	Set	1	7,571	83024200
	9183533	9183533	Rearmost Door Set Right side for Doors	1	Set	1	7,571	83024200
	9154933	9154933	Soft Opening & Closing System	1	Set	1	18,143	39263000
	9135004	9135004	4000 mm Predrilled Runner profile, Guide Profile and Cover Profile	1	Set	1	23,516	83024200

Product	Article No.	SAP	Item Description	Qty.	Unit	PU	MRP	HS Code
TopLine XL 4 Door Synchronised – Weight 80 Kg per Door with Soft Closing & Soft Opening; Max. Door Dimensions: Height-2600 mm & width-1000 mm								
	9181742	9181742	Frontmost Door Set for 19 mm max. door thickness EB 30	1	Set	1	12,611	83024200
	9196841	9196841	Front most door set for synchronisation EB 30	1	Set	1	25,675	83024200
	9183613	9183613	Frontmost Door Set for 22 mm max. door thickness EB 33	1	Set	1	12,611	83024200
	9199006	9199006	Front most door set for synchronisation EB 33	1	Set	1	25,675	83024200
	9183615	9183615	Frontmost Door Set for 28 mm max. door thickness EB 39	1	Set	1	12,611	83024200
	9199007	9199007	Front most door set for synchronisation EB 39	1	Set	1	25,675	83024200
	9181744	9181744	Rearmost Door Set Left side	1	Set	1	7,571	83024200
	9183533	9183533	Rearmost Door Set Right side	1	Set	1	7,571	83024200
	9185664	9185664	Soft Opening & Closing System for 4 Doors	1	Set	1	25,266	83024200
	9191156	9191156	3000 mm Reinforced & Predrilled Runner profile, Guide Profile and Cover Profile	1	Set	1	34,089	83024200
	9191157	9191157	4000 mm Reinforced & Predrilled Runner profile, Guide Profile and Cover Profile	1	Set	1	44,269	83024200
	TopLine XL Accessories							
	9137352	9137352	2000 mm Cover Profile for Frontmost Door	1	Set	1	1,424	39263000

TopLine L

TopLine L 2 Door Advanced – Weight 50 Kg per Door with Soft Closing & Soft Opening; Max. Door Dimensions: Height-2600 mm & Width- 1500 mm								
	9206502	9206502	Frontmost Door Set for 25 mm max. door thickness EB 37	1	Set	1	5,770	83024200
	9206503	9206503	Frontmost Door Set for 40 mm max. door thickness EB 52	1	Set	1	8,858	83024200
	9206507	9206507	Rearmost Door Set Left/Right side	1	Set	1	2,569	83024200
	9182589	9182589	Silent System soft closing set, 2-door	1	Set	1	7,904	39263000
	9182572	9182572	Silent System soft opening set, 2-door	1	Set	1	3,756	39263000
	9199769	9199769	Silent System soft guiding set	1	Set	1	1,671	39263000
	9182574	9182574	Silent System soft closing set, 3-door	1	Set	1	19,418	39263000
	9182573	9182573	Silent System soft opening set, 3-door	1	Set	1	17,858	39263000
	9184801	9184801	3000 mm Runner profile and Guide Profile	1	Pc	1	12,564	76042990
	9184809	9184809	4000 mm Runner profile and Guide Profile	1	Pc	1	29,380	76042990



Product	Article No.	SAP	Item Description	Qty.	Unit	PU	MRP	HS Code
TopLine 22								
	TopLine 22: 2 Door with STB 11 (Frontmost Door on Right) for Wooden & Aluminium Profile Doors Weight 50 kg per door; Max Door Dimensions: H-2500 & Width-1500 for 21 mm thickness							
	13431	13431	Set 2-Door for thickness 21 mm	1	Set	1	5,096	83024200
	45080	45080	STB 11 Set 2-Doors	1	Set	1	1,659	83024200
	71111	9288912	Runner profile 3000 mm Silver Alu.	1	Pc	4	1,678	76042990
	71117	71117	STB 11 Guide profile 3000 mm Alu.	1	Pc	4	1,595	76042990
		Total Set					10,028	
	TopLine 22: 2 Door with STB 12 (Frontmost Door on Right) for Wooden & Aluminium Profile Doors Weight 50 kg per door; Max Door Dimensions: H-2500 mm & Width-1500 mm for 21 mm thickness							
	13431	13431	Set 2-Door for thickness 21 mm	1	Set	1	5,096	83024200
	45082	45082	STB 12 Set 2-Doors	1	Set	1	1,773	83024200
	71111	9288912	Runner profile 3000 mm Silver Alu.	1	Pc	4	1,678	76042990
	71116	9288835	STB 12 Guide profile 3000 mm Alu.	1	Pc	4	1,717	76042990
		Total Set					10,264	
	TopLine 22: 2 Door with STB 15 (Frontmost Door on Right) for Wooden & Aluminium Profile Doors Weight 50kg per door; Max Door Dimensions: H-2500 mm & Width-1500 mm for 21 mm Thickness							
	13431	13431	Set 2-Door for thickness 21 mm	1	Set	1	5,096	83024200
	45199	45199	STB 15 Set 2-Doors	1	Set	1	2,033	83024200
	71111	9288912	Runner profile 3000 mm Silver Alu.	1	Pc	4	1,678	76042990
	71115	71115	STB 15 Guide profile 3000 mm Alu.	1	Pc	4	2,023	76042990
		Total Set					10,830	
	TopLine 22: 3 Door with STB 11 for Wooden & Aluminium Profile Doors- Weight 50kg per door; Max Door Dimensions: H-2500 mm & Width-1500 mm for 21 mm Thickness							
	13433	13433	Set 3-Door for thickness 21 mm	1	Set	1	6,449	83024200
	45081	45081	STB 11 Set 3-Doors	1	Set	1	1,974	83024200
	71111	9288912	Runner profile 3000mm Silver Alu.	1	Pc	4	1,678	76042990
	71117	71117	STB 11 Guide profile 3000mm Alu.	1	Pc	4	1,595	76042990
		Total Set					11,696	
	TopLine 22: 3 Door with STB 12 for Wooden & Aluminium Profile Doors - Weight 50kg per door; Max Door Dimensions: H-2500 mm & Width-1500 mm for 21 mm Thickness							
	13433	13433	Set 3-Door for thickness 21 mm	1	Set	1	6,449	83024200
	45083	45083	STB 12 Set 3-Doors	1	Set	1	2,212	83024200
	71111	9288912	Runner profile 3000mm Silver Alu.	1	Pc	4	1,678	76042990
	71116	9288835	STB 12 Guide profile 3000 mm Alu.	1	Pc	4	1,717	76042990
		Total Set					12,056	
	Top Line 22, 50 Kg/ Door , Wodden & Aluminium (Other Options)							
	13432	13432	Set Front Door on left for thickness 21 mm	1	Set	1	5,097	83024200
	9080202	9080202	Set Front Door on left for thickness 28 mm	1	Set	1	5,616	83024200
	46418	46418	Cover Profile 1000 mm	1	Pc	4	689	39169090

Product	Article No.	SAP	Item Description	Qty.	Unit	PU	MRP	HS Code
TopLine 22 Advanced								
	TopLine 22 2 Door Advanced with STB 11 (Frontmost Door on Right) for Wooden & Aluminium Profile Doors - Weight 50 kg per door; Max Door Dimensions: Height -2500 mm & Width -1500 mm for 28 mm thickness							
	9080201	9080201	Top Door Runner set for Door Thickness 28 mm (Max.)	1	Set	1	5,616	83024200
	45080	45080	STB 11 Guide Set	1	Set	1	1,659	83024200
	71111	9288912	Runner profile 3000 mm Silver Alu.	1	Pc	4	1,678	76042990
	71117	71117	STB 11 Guide profile 3000 mm Alu.	1	Pc	4	1,595	76042990
		Total Set				10,548		
	TopLine 22: 2 Door Advanced with STB 12 (Frontmost Door on Right) for Wooden & Aluminium Profile Doors - Weight 50 kg per door; Max Door Dimensions: Height -2500 mm & Width -1500 mm for 28 mm thickness							
	9080201	9080201	Top Door Runner set for Door Thickness 28 mm (Max.)	1	Set	1	5,616	83024200
	45082	45082	STB 12 Guide Set	1	Set	1	1,773	83024200
	71111	9288912	Runner profile 3000 mm Silver Alu.	1	Pc	4	1,678	76042990
	71116	9288835	STB 12 Guide profile 3000 mm Alu.	1	Pc	4	1,717	76042990
		Total Set				10,784		
	TopLine 22: 2 Door Advanced with STB 15 (Frontmost Door on Right) for Wooden & Aluminium Profile Doors - Weight 50 kg per door; Max Door Dimensions: Height -2500 mm & Width -1500 mm for 28 mm thickness							
	9080201	9080201	Top Door Runner set for Door Thickness 28 mm (Max.)	1	Set	1	5,616	83024200
	45199	45199	STB 15 Guide Set	1	Set	1	2,033	83024200
	71111	9288912	Runner profile 3000 mm Silver Alu.	1	Pc	4	1,678	76042990
	71115	71115	STB 15 Guide profile 3000 mm Alu.	1	Pc	4	2,023	76042990
		Total Set				11,350		
	TopLine 22: 3 Door Advanced with STB 11 for Wooden & Aluminium Profile Doors - Weight 50 kg per door; Max Door Dimensions: Height -2500 mm & Width -1500 mm for 28 mm Thickness							
	9080203	9080203	Top Door Runner set for Door Thickness 28 mm (Max.)	1	Set	1	7,416	83024200
	45081	45081	STB 11 Guide Set	1	Set	1	1,974	83024200
	71111	9288912	Runner profile 3000 mm Silver Alu.	1	Pc	4	1,678	76042990
	71117	71117	STB 11 Guide profile 3000 mm Alu.	1	Pc	4	1,595	76042990
		Total Set				12,663		
	TopLine 22: 3 Door Advanced with STB 12 for Wooden & Aluminium Profile Doors - Weight 50kg per door; Max Door Dimensions: Height -2500 mm & Width -1500 mm for 28 mm Thickness							
	9080203	9080203	Top Door Runner set for Door Thickness 28 mm (Max.)	1	Set	1	7,416	83024200
	45083	45083	STB 12 Guide Set	1	Set	1	2,212	83024200
	71111	9288912	Runner profile 3000 mm Silver Alu.	1	Pc	4	1,678	76042990
	71116	9288835	STB 12 Guide profile 3000 mm Alu.	1	Pc	4	1,717	76042990
		Total Set				13,023		
	TopLine 22 Silent System soft closing set & Cover Profile							
	9084432	9084432	Silent System soft closing set-2 Door	1	Set	1	6,243	39263000
	9096761	9096761	Silent System soft closing set-3 Door	1	Set	1	6,603	39263000
	46418	46418	Cover Profile 1000 mm	1	Pc	1	689	39169090

Product	Article No.	SAP	Item Description	Qty.	Unit	PU	MRP	HS Code
---------	-------------	-----	------------------	------	------	----	-----	---------

Top Running & Inset Wardrobe/Cabinet Sliding Fittings

TopLine 110



**Topline 110: 2 Door for Wooden & Aluminium Profile Doors – Weight 20 kg per door;
Max Door Dimensions: Height 2000 mm & Width 500-1500 mm**

9040230	9040230	Aluminium Runner Profile 3000 mm for gluing in	1	Pc	1	1,832	76042990
45317	45317	Topline 110 Set for 2 Door Cabinet (for 16-19 mm door thickness)	1	Set	1	2,770	83024200
9079731	9079731	Silent System for Wooden Door only (Max door weight 20kg)	1	Set	1	3,880	39263000







TopLine M



**Topline M: 2 Door for Wooden Doors – Weight 35 kg per door;
Max Door Dimensions: Height 2300 mm & Width 500-1250 mm**

9133641	9133641	2 Door Runner Set for guide system 16.2	1	Set	1	4,153	83024200
9144901	9144901	Set silent system 2 door	1	Set	1	3,412	39263000
9117425	9117425	Top-Line M(35) Runner Track 2000 mm	1	Pc	1	2,326	76042990
9117429	9117429	STB 16.2 Guide Track Under 2000 mm	1	Pc	1	562	39169090
9200386	9200386	Top-Line M(35) Brush Strip Grey 2100 mm	1	Pc	1	227	39269097



Product	Article No.	SAP	Item Description	Qty.	Unit	PU	MRP	HS Code
TopLine 1								
	Topline 1: 2 Door for Wooden Doors with STB 11- Weight 50 kg per door; Max Door Dimensions : Height 1500-2500 mm & Width 500-1500 mm							
	45076	45076	Top Door Runner Set for 2 Doors	1	Set	1	2,712	83024200
	71113	71113	Aluminium Runner Profile 3000 mm	1	Pc	4	2,422	76042990
	71117	71117	STB 11 Aluminium Guide profile 3000 mm	1	Pc	4	1,595	76042990
	45080	45080	STB 11 Guide Set for 2-Doors	1	Set	1	1,659	83024200
			Total Set				8,388	
	Topline 1: 2 Door for Wooden Doors with STB 12- Weight 50 kg per door; Max Door Dimensions : Height 1500-2500 mm & Width 500-1500 mm							
	45076	45076	Top Door Runner Set for 2 Doors	1	Set	1	2,712	83024200
	71113	71113	Aluminium Runner Profile 3000 mm	1	Pc	4	2,422	76042990
	71116	9288835	STB 12 Aluminium Guide profile 3000 mm	1	Pc	4	1,717	76042990
	45082	45082	STB 12 Guide Set for 2-Doors	1	Set	1	1,773	83024200
			Total Set				8,624	
	Topline 1: 2 Door for Wooden Doors with STB 35- Weight 50 kg per door; Max Door Dimensions : Height 1500-2500 mm & Width 500-1500 mm							
	45076	45076	Top Door Runner Set for 2 Doors	1	Set	1	2,712	83024200
	71113	71113	Aluminium Runner Profile 3000 mm	1	Pc	4	2,422	76042990
	46790	46790	STB 35 plastic guide profile 3500 mm	2	Pc	25	442	39169090
	25119	25119	STB 35 Guide Set for 2-Doors	2	Set	100	57	39263000
			Total Set				5,633	
	Topline 1: 2 Door for Wooden Doors with STB 11- Weight 75 kg per door; Max Door Dimensions : Height 1500-2500 mm & Width 500-1500 mm							
	45078	45078	Top Door Runner Set for 2 Doors	1	Set	1	4,633	83024200
	71113	71113	Aluminium Runner Profile 3000 mm	1	Pc	4	2,422	76042990
	71117	71117	STB 11 Aluminium Guide profile 3000 mm	1	Pc	4	1,595	76042990
	45080	45080	STB 11 Guide Set for 2-Doors	1	Set	1	1,659	83024200
			Total Set				10,309	
	Topline 1: 2 Door for Wooden Doors with STB 12 - Weight 75 kg per door; Max Door Dimensions: Height 1500-2500 mm & Width 500-1500 mm							
	45078	45078	Top Door Runner Set for 2 Doors	1	Set	1	4,633	83024200
	71113	71113	Aluminium Runner Profile 3000 mm	1	Pc	4	2,422	76042990
	71116	9288835	STB 12 Aluminium Guide profile 3000 mm	1	Pc	4	1,717	76042990
	45082	45082	STB 12 Guide Set for 2-Doors	1	Set	1	1,773	83024200
			Total Set				10,545	
	Topline 1: 2 Door for Wooden Doors with STB 35 - Weight 75 kg per door; Max Door Dimensions: Height 1500-2500 mm & Width 500-1500 mm							
	45078	45078	Top Door Runner Set for 2 Doors	1	Set	1	4,633	83024200
	71113	71113	Aluminium Runner Profile 3000 mm	1	Pc	4	2,422	76042990
	46790	46790	STB 35 plastic guide profile 3500 mm	2	Pc	25	442	39169090
	25119	25119	STB 35 Guide Set for 2-Doors	2	Set	100	57	39263000
			Total Set				7,554	

Product	Article No.	SAP	Item Description	Qty.	Unit	PU	MRP	HS Code
	Topline 1: 3 Door for Wooden Doors with STB 11 - Weight 50 kg per door; Max Door Dimensions: Height 1500-2500 mm & Width 500-1500 mm							
	45077	45077	Top Door Runner Set for 3 Doors	1	Set	1	3,585	83024200
	71113	71113	Aluminium Runner Profile 3000 mm	1	Pc	4	2,422	76042990
	71117	71117	STB 11 Aluminium Guide profile 3000 mm	1	Pc	4	1,595	76042990
	45081	45081	STB 11 Guide Set for 3-Doors	1	Set	1	1,974	83024200
			Total Set				9,576	
	Topline 1: 3 Door for Wooden Doors with STB 12 - Weight 50 kg per door; Max Door Dimensions: Height 1500-2500 mm & Width 500-1500 mm							
	45077	45077	Top Door Runner Set for 3 Doors	1	Set	1	3,585	83024200
	71113	71113	Aluminium Runner Profile 3000 mm	1	Pc	4	2,422	76042990
	71116	9288835	STB 12 Aluminium Guide profile 3000 mm	1	Pc	4	1,717	76042990
	45083	45083	STB 12 Guide Set for 3-Doors	1	Set	1	2,212	83024200
			Total Set				9,936	
	Topline 1: 3 Door for Wooden Doors with STB 35 - Weight 50 kg per door; Max Door Dimensions: Height 1500-2500 mm & Width 500-1500 mm							
	45077	45077	Top Door Runner Set for 3 Doors	1	Set	1	3,585	83024200
	71113	71113	Aluminium Runner Profile 3000 mm	1	Pc	4	2,422	76042990
	46790	46790	STB 35 plastic guide profile 3500 mm	2	Pc	25	442	39169090
	25119	25119	STB 35 Guide Set for 3-Doors	3	Set	100	86	39263000
			Total Set				6,535	
	Topline 1: 3 Door for Wooden Doors with STB 11 - Weight 75 kg per door; Max Door Dimensions: Height 1500-2500 mm & Width 500-1500 mm							
	45079	45079	Top Door Runner Set for 3 Doors	1	Set	1	6,561	83024200
	71113	71113	Aluminium Runner Profile 3000 mm	1	Pc	4	2,422	76042990
	71117	71117	STB 11 Aluminium Guide profile 3000 mm	1	Pc	4	1,595	76042990
	45081	45081	STB 11 Guide Set for 3-Doors	1	Set	1	1,974	83024200
			Total Set				12,552	
	Topline 1: 3 Door for Wooden Doors with STB 12 - Weight 75 kg per door; Max Door Dimensions: Height 1500-2500 mm & Width 500-1500 mm							
	45079	45079	Top Door Runner Set for 3 Doors	1	Set	1	6,561	83024200
	71113	71113	Aluminium Runner Profile 3000 mm	1	Pc	4	2,422	76042990
	71116	9288835	STB 12 Aluminium Guide profile 3000 mm	1	Pc	4	1,717	76042990
	45083	45083	STB 12 Guide Set for 3-Doors	1	Set	1	2,212	83024200
			Total Set				12,952	
	Topline 1: 3 Door for Wooden Doors with STB 35 - Weight 75 kg per door; Max Door Dimensions: Height 1500-2500 mm & Width 500-1500 mm							
	45079	45079	Top Door Runner Set for 3 Doors	1	Set	1	6,561	83024200
	71113	71113	Aluminium Runner Profile 3000 mm	1	Pc	4	2,422	76042990
	46790	46790	STB 35 plastic guide profile 3500 mm	2	Pc	25	442	39169090
	25119	25119	STB 35 Guide Set for 3-Doors	3	Set	100	86	39263000
			Total Set				9,511	

Product	Article No.	SAP	Item Description	Qty.	Unit	PU	MRP	HS Code
---------	-------------	-----	------------------	------	------	----	-----	---------

Bottom Running & Overlay & Inset Cabinet Door Sliding Fittings

SlideLine M

**SlideLine M: 1 Door for Wooden & Aluminium framed Doors - Weight 30 kg per door;
Max Door Dimensions: Height 2000 mm & Width 300-1800 mm**



9156338	9156338	Set fitting SlideLine M with Silent system for Wooden & 55 mm Alu. Profile Doors (Min. Width 450 mm; Weight Max. 30kg; Self Thickness 16-25 mm)	1	Set	1	7,457	83024200
9156339	9156339	Set fitting SlideLine M, for Wooden & 55mm Alu. Profile Doors (Min. Width 300 mm; Weight Max. 30 kg; Self Thickness 16-25 mm)	1	Set	1	4,361	83024200
9209225	9209225	Profile Set SL-M 18/2500 mm 1 Profile	1	Set	1	5,833	76042990
9209226	9209226	Profile Set SL-M 18/4000 mm 1 Profile	1	Set	1	8,341	76042990
9209228	9209228	Profile Set SL-M 22/2500 mm 1 Profile	1	Set	1	6,155	76042990
9209229	9209229	Profile Set SL-M 22/4000 mm 1 Profile	1	Set	1	8,985	76042990
9209230	9209230	Profile Set SL-M 25/2500 mm 1 Profile	1	Set	1	6,380	76042990
9209231	9209231	Profile Set SL-M 25/4000 mm 1 Profile	1	Set	1	8,978	76042990
9209277	9209277	Decorative Silver Cover for 18 mm /2500 mm	1	Set	1	2,248	39199080
9209278	9209278	Decorative Silver Cover for 18 mm /4000 mm	1	Set	1	3,214	39269097
9209287	9209287	Decorative Silver Cover for 22 mm /4000 mm	1	Set	1	3,366	39269097
9209399	9209399	Decorative Silver Cover for 25 mm /2500 mm	1	Set	1	2,362	39269097
9209400	9209400	Decorative Silver Cover for 25 mm /4000 mm	1	Set	1	3,218	39269097

SlideLine 66



**SlideLine 66: 1 Door for Wooden & Alu.framed Doors- Weight 10 kg per door;
Max Door Dimensions: Height 800 mm & Width 400-1500 mm**

20143	9125955	Cover Profile 3000 mm Silver	1	Pc	4	215	39169090
20142	20142	Aluminium Runner Profile 3000 mm Silver	1	Pc	4	1,937	76042990
20145	20145	Slide-Line 66 Set for Wooden and Aluminium Profile doors (for 16-19 mm thick door)	1	Set	1	1,533	83024200

SlideLine 55



**SlideLine 55: 2 Door for Wooden Doors - Weight 15 kg per door with Plastic Runner Profile;
Max Door Dimensions: Height 1500 mm & Width 400-2000 mm**

25121	1010501	Profile 4000mm Brown	1	Pc	20	256	39169090
25122	1006347	Running Component for 15kg door (For 16-19mm thick door)	1	Pc	100	56	39263000
25123	1006263	Guide Component with Spring loaded bolt (For 16-19mm thick door)	1	Pc	100	69	39263000
47392	47392	Door Stopper Press-In for 15kg door	1	Pc	100	16	39263000
9079731	9079731	Add-On Silent System (max door weight 20 kg)	1	Pc	1	3,880	39263000

SlideLine 55 Plus



**SlideLine 55 Plus: 2 Door for Wooden Doors - Weight 15-30 kg per door;
Max Door Dimensions: Height 1500 mm & Width 400-2000 mm**

1057668	1057668	Runner & guide profile Alu 4000 mm	1	Pc	4	1,080	76042990
9115217	9115217	Guiding part STB 55 plus	1	Pc	100	117	83024200
9115219	9115219	SL 55 plus running part	1	Pc	100	267	39263000
9115216	9115216	Spacer STB 55 plus	1	Pc	100	51	39269097
9119584	9119584	Silent system SL 55plus left	1	Pc	30	1,048	83024200
9119585	9119585	Silent system SL 55plus right	1	Pc	30	1,048	83024200
9118477	9118477	Assembly activator SISY SL 55	1	Pc	300	93	39263000

Product	Article No.	SAP	Item Description	Qty.	Unit	PU	MRP	HS Code
---------	-------------	-----	------------------	------	------	----	-----	---------

SlideLine 56



SlideLine 56: 2 Door for Wooden Doors- Weight 40 kg per door; Max Door Dimensions: Height 2000 mm & Width 500-1000 mm								
1015936	9288854		Aluminium Runner Profile 2000 mm Silver	1	Pc	16	235	76042990
71110	9288856		Aluminium Runner Profile 3000 mm Silver	1	Pc	4	334	76042990
45234	9266143		2 Door Kit for 1 cabinet (16-19 mm thick door)	1	Set	1	1,457	83024200
45235	45235		3 Door Kit for 1 cabinet (16-19 mm thick door)	1	Set	1	2,661	39263000
9079731	9079731		Add-On Silent System (max door weight 20kg)	1	Set	1	3,880	39263000

SlideLine Grant 400 Neo



SlideLine Grant 400 Neo: 2/3 Door (Floor to Ceiling) Sliding system with Soft Closing & Soft Opening; Max Door Dimensions: Height 3500 mm & Width 1200 mm								
9289653	9289653		Soft closing Dampers, Rollers & Fixing Materials	1	Set	1	2,475	83024100
9289893	9289893		Grant 400 Neo Upper track, 3600 mm SA	1	Pc	1	3,201	76042990
9289894	9289894		Grant 400 Neo Upper track, 2400 mm SA	1	Pc	1	2,135	76042990
9289895	9289895		Grant 400 Neo Bottom track, 3600 mm SA	1	Pc	1	1,583	76042990
9289897	9289897		Grant 400 Neo Bottom track, 2400 mm SA	1	Pc	1	1,055	76042990
9289899	9289899		Grant 400 Middle door frame, 1200 mm SA	1	Pc	1	513	76042990
9289900	9289900		Grant 400 Upper door frame, 1200 mm SA	1	Pc	1	386	76042990
9289901	9289901		Grant 400 Vertical door frame, 3500 mm SA	1	Pc	1	1,941	76042990
9289902	9289902		Grant 400 Bottom door frame, 1200 mm SA	1	Pc	1	666	76042990
9293855	9293855		Glass Sealing Strip 6mm for Grant 400 Neo, 1200mm	1	Pc	1	81	39204900
9293856	9293856		Glass Sealing Strip 6mm for Grant 400 Neo, 3500mm	1	Pc	1	235	39204900
9293857	9293857		Fixing Screw ST 6x30mm for Grant 400 Neo Profiles	5	Pc	1	70	73181400
9295418	9295418		Sealing Brush 7x8mm, 3500 mm	1	Pc	1	120	39204900

Vertically running Door Sliding Fittings

Vertico Synchro

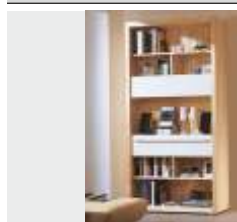

Vertico Synchro: 2 Door for Wooden and Aluminium Profile Doors - Weight 15 kg per door; Max Door Dimensions: Height 400-600 mm & Width 1500 mm max.								
20386	20386		Vertico Synchro Set 400 for Overlay Door height 400-600 mm	1	Set	1	24,313	83024200
20400	20400		Cover Profile 2500 mm Aluminium Silver anodised	2	Pc	1	3,484	76042990

Vertico Mono









Vertico Mono: 1 Door for Wooden and Aluminium Profile Doors - Weight 15 kg per door; Max Door Dimensions: Height 400-700 mm & Width 1500 mm max.								
45315	45315		Set Vertico Mono for inset door	1	Set	1	20,475	83024200
20400	20400		Cover Profile 2500 mm Aluminium Silver anodised	2	Pc	1	3,484	76042990

Swivel system

HorizonPlus Swivel system









Horizon Plus: Sliding Door for Wooden & Aluminium Profile Door - Weight 20 kg per door; max door Dimensions: Height 2600 mm & Width 400-700 mm								
9080210	9080210		Horizon Plus Single Door Kit for internal height 2570 mm and Door Width 400-515 mm	1	Set	1	44,012	94039010
48078	48078		Horizon Plus Single Door Kit for internal height 2570 mm and Door Width 475-700 mm	1	Set	1	41,659	83024200



Product	Article No.	SAP	Item Description	Qty.	Unit	PU	MRP	HS Code
Folding Door System for Wardrobe / Cabinet								
WingLine								
	Wingline L Push to move - Weight 5 kg to 12 kg per wing ; Max Door Dimensions : 2400 mm Height & 600 mm Door Wing Width (Order Sensys 8675 Hinges Separately)							
	9237901	9237901	Wing Line L Kit - Left	1	Pc	1	2,044	83024200
	9237900	9237900	Wing Line L Kit - Right	1	Pc	1	2,044	83024200
	9238051	9238051	Push to Move Mechanisms Medium- Left	1	Pc	1	8,133	83024200
	9238101	9238101	Push to Move Mechanisms Medium- Right	1	Pc	1	8,133	83024200
	9237917	9237917	Runner Profile - 2400 mm	1	Pc	1	2,256	76042990
9237758	9237758	Profile Mounting Clip	2	Pc	1	188	39269097	
	Wingline L Push to move - Weight 12 kg to 25 Kg per wing ; Max Door Dimensions : 2400 mm Height & 600 mm Door Wing Width (Order Sensys 8675 Hinges Separately)							
	9237880	9237880	Wing Line L Kit - Left	1	Pc	1	3,414	83024200
	9237881	9237881	Wing Line L Kit - Right	1	Pc	1	3,414	83024200
	9238052	9238052	Push to Move Mechanisms Heavy - Left	1	Pc	1	7,976	83024200
	9238053	9238053	Push to Move Mechanisms Heavy - Right	1	Pc	1	7,976	39263000
	9239310	9239310	Runner Profile - 2400 mm	1	Pc	1	3,764	76042990
9264191	9264191	Mechanical Catch	1	Set	50	889	83024200	
	Wingline L Pull to move - Weight 5 kg to 12 kg per wing ; Max Door Dimensions : 2400 mm Height & 600 mm Door Wing Width (Order Sensys 8675 Hinges Separately)							
	9237901	9237901	Wing Line L Kit - Left	1	Pc	1	2,044	83024200
	9237900	9237900	Wing Line L Kit - Right	1	Pc	1	2,044	83024200
	9238115	9238115	Pull to move Mechanisms Medium- Left	1	Pc	1	8,133	83024200
	9238116	9238116	Pull to move Mechanisms Medium- Right	1	Pc	1	8,133	83024200
	9237917	9237917	Runner Profile - 2400 mm	1	Pc	1	2,256	76042990
9237758	9237758	Profile Mounting Clip	2	Pc	1	188	39269097	
	Wingline L Pull to move - Weight 12 kg to 25 Kg per wing ; Max Door Dimensions : 2400 mm Height & 600 mm Door Wing Width (Order Sensys 8675 Hinges Separately)							
	9237880	9237880	Wing Line L Kit - Left	1	Pc	1	3,414	83024200
	9237881	9237881	Wing Line L Kit - Right	1	Pc	1	3,414	83024200
	9238125	9238125	Pull to move Mechanisms Heavy - Left	1	Pc	1	7,976	83024200
	9238114	9238114	Pull to move Mechanisms Heavy - Right	1	Pc	1	7,976	83024200
	9239310	9239310	Runner Profile - 2400 mm	1	Pc	1	3,764	76042990
	Wingline L Pull to move Silent - Weight 5 kg to 12 kg per wing ; Max Door Dimensions : 2400 mm Height & 600 mm Door Wing Width (Order Sensys 8645i Hinges Separately)							
	9237903	9237903	Wing Line L Kit - Left	1	Pc	1	2,044	83024200
	9237902	9237902	Wing Line L Kit - Right	1	Pc	1	2,044	83024200
	9238121	9238121	Pull to move Silent Mechanisms Medium- Left	1	Pc	1	6,577	83024200
	9238124	9238124	Pull to move Silent Mechanisms Medium- Right	1	Pc	1	6,577	83024200
	9237917	9237917	Runner Profile - 2400 mm	1	Pc	1	2,256	76042990
9237758	9237758	Profile Mounting Clip	2	Pc	1	188	39269097	
	Wingline L Pull to move Silent - Weight 12 kg to 25 Kg per wing ; Max Door Dimensions : 2400 mm Height & 600 mm Door Wing Width (Order Sensys 8645i Hinges Separately)							
	9237852	9237852	Wing Line L Kit - Left	1	Pc	1	3,414	83024200
	9237890	9237890	Wing Line L Kit - Right	1	Pc	1	3,414	83024200
	9238123	9238123	Pull to move Silent Mechanisms Heavy - Left	1	Pc	1	7,341	39269097
	9238122	9238122	Pull to move Silent Mechanisms Heavy - Right	1	Pc	1	7,341	39269097
	9239310	9239310	Runner Profile - 2400 mm	1	Pc	1	3,764	76042990

Product	Article No.	SAP	Item Description	Qty.	Unit	PU	MRP	HS Code
	WingLine 230: 2 Doors with 4 Wings for Wooden Doors – Weight 20–25 kg per door; Max Door Dimensions: Height 3000mm & Door wing Width 600 mm (Order Hinges Separately)							
	79013	1079849	Runner profile Aluminium White 2400 mm	1	Pc	4	7,285	76042990
	79015	9225395	WingLine 230 Set of 4 Wings (Left & Right) (16–25 mm Door thickness)	1	Set	1	23,498	83024200
	Wingline 170: 1 Door with 2 Wings for Wooden/Aluminium Profile Doors – Weight depends on hinges used; Max Door Dimensions: Height 2200 mm & Door wing Width 300 mm (Order Hinges Separately)							
	74658	74658	Wingline 170 set	1	Set	1	1,289	83024200
	71648	1069932	Centre Folding Door Hinge 625 (Nickel plated Steel)	1	Pc	4	35	83021000
	Accessories for Sliding & Folding Doors							
	45198	9189775	Door Bend Adjustment Rod Fitting - Plastic	1	Set	1	952	83024200
	9117303	9117303	Door Bend Adjustment Rod Fitting - Aluminium	1	Set	2	6,554	83024200
	26453	26453	Brush Sealing Strip 2500mm (27 mm height.; Screw on Brown)	1	Pc	40	1,289	39269097
	9200386	9200386	Self Adhesive Brush Sealing Strip 2500 mm (8 mm height.)	1	Pc	1	227	39269097
	9073662	9073662	Sensys 8675 Hinge ; Opening Angle 110° for Push to move and Pull to Move Mechanisms	1	Pc	1	228	83021000
	9071575	9091575	Sensys Mount Plate	1	Pc	1	24	83021000
9237758	9237758	Profile Mounting Clip	1	Pc	1	94	39269097	







Product	Product Section	Details	Article No.	SAP	Unit	PU	MRP	HS Code
Aluminum Door Profiles for 2/3 Sliding Door Carcases (Door thickness 18–19 mm)								
		Door Profile Predrilled 18–19mm L 2500 mm	9136121	9136121	Pc	01	2,089	76042990
		Door Profile U-Shaped Predrilled 18–19mm L 2500 mm	9136122	9136122	Pc	01	1,568	76042990







Product	Article No.	SAP	Item Description	Qty.	Unit	PU	MRP	HS Code
Top Running Sliding & Folding Door System as Space Dividers								
Sliding								
	Topline 80: Single profile Top Running Door – Weight 80 kg/door; Max Door Dimensions: Width1000/1500 mm (Max.)							
	14005	9089915	Kit for 1 Door (Door Thickness : 25 mm upwards)	1	Set	1	3,143	76042990
	14006	9089914	Runner profile anodised aluminium profile 2000 mm	1	Pc	4	1,580	76042990
	9083102	9083102	Runner profile anodised aluminium profile 3000 mm	1	Pc	4	2,206	76042990
	Topline 80 SiSy: Single Profile Top Running Door with soft closing & soft opening – Weight 80 kg/door; Max Door Dimensions: Width1000/1500 mm (Max.)							
	9289654	9289654	Sliding Kit for 80 kg door with Silent system (Opening & Closing)	1	Set	1	4,769	83024100
	9289905	9289905	Runner profile anodised aluminium profile 2000 mm	1	Pc	1	1,580	76042990
	9289904	9289904	Runner profile anodised aluminium profile 3000 mm	1	Pc	1	2,206	76042990
	Slideline 16: 2 Door for Wooden doors with 2 m screw on track –Weight 60 kg per door; thickness 16–24 mm							
	9226025	9226025	SL 16- Fitting Set	1	Set	1	1,460	83024200
	9239411	9288847	SL 16- Profile Set Screw 2000 mm	1	Set	1	1,745	76169990
	9226028	9226028	Silent System	1	Set	1	893	83024200
			Total Set				4,098	
	Slideline 16: 2 Door for Wooden doors with 3 m screw on track –Weight 60 kg per door; thickness 16–24 mm							
	9226025	9226025	SL 16- Fitting Set	1	Set	1	1,460	83024200
	9226026	9288846	SL 16- Profile Set Screw 3000 mm	1	Set	1	3,030	76169990
	9226028	9226028	Silent System	1	Set	1	893	83024200
			Total Set				5,383	
	Grant 1230 with 3000 mm Runner, 147 Kg / Door, max. height 3000 mm & min. thickness 25.5 mm							
	50125	50125	Runner profile, 3000 mm	1	Pc	4	4,321	76042990
	48295	1133278	Kit for 1 door	1	Set	1	5,920	83024190
	50140	50140	TopLine 1230 Bumper stop	1	Pc	2	1,021	83024200
	50562	50562	Floor Guide Tab Steel	1	Pc	10	373	83024200
			Total Set				11,635	
	Grant 1230 with 3600 mm Runner, 147 Kg / Door, max. height 3000 mm & min. thickness 25.5 mm							
	50126	50126	Runner profile, 3600 mm	1	Pc	4	6,324	76041090
	48295	1133278	Kit for 1 door	1	Set	1	5,920	83024190
	50140	50140	TopLine 1230 Bumper stop	1	Pc	2	1,021	83024200
	50562	50562	Floor Guide Tab Steel	1	Pc	10	373	83024200
			Total Set				13,638	

Product	Article No.	SAP	Item Description	Qty.	Unit	PU	MRP	HS Code
	Grant 1260 with 3000 mm Runner (For Heavy Duty Folding Doors) - 80 Kg / Door							
	1133284	1133284	Kit for 1 fold	1	Set	1	10,376	83024200
	50146	50146	Guide profile, 3000 mm	1	Pc	4	2,298	76041090
	50125	50125	Runner profile, 3000 mm	1	Pc	4	4,321	76042990
	50141	50141	Guide rollers	1	Pc	1	859	83024190
			Total Set				17,854	
	Grant 1260 with 3600 mm Runner (For Heavy Duty Folding Doors) - 80 Kg / Door							
	1133284	1133284	Kit for 1 fold	1	Set	1	10,376	83024200
	50147	50147	Guide profile, 3600 mm	1	Pc	4	2,461	76041090
	50126	50126	Runner profile, 3600 mm	1	Pc	4	6,324	76041090
	50141	50141	Guide rollers	1	Pc	1	859	83024190
			Total Set				20,020	



Product	Article No.	SAP	Item Description	Qty.	Unit	PU	MRP	HS Code
Grand SD for door weight 68 kg								
	TopLine Grant SD Set Standard 8 feet with Silent System							
	9199838	9288888	Single Track 8 feet	1	Pc	1	18,895	83024190
	9191124	9191124	Standard Hardware Set	1	Set	1	7,136	83024190
	9235608	9235608	Silent System SD	1	Pc	1	13,786	83024190
	Total Set							39,817
	TopLine Grant SD Set Low Profile 8 feet with Silent System							
	9199838	9288888	Single Track 8 feet	1	Pc	1	18,895	83024190
	9203725	9203725	Low profile Hardware Set	1	Set	1	25,053	83024190
	9235608	9235608	Silent System SD	1	Pc	1	13,786	83024190
	Total Set							57,734
	TopLine Grant SD Set Standard 10 feet with Silent System							
	9199839	9288889	Single Track 10 feet	1	Pc	1	15,748	83024190
	9191124	9191124	Standard Hardware Set	1	Set	1	7,136	83024190
	9235608	9235608	Silent System SD	1	Pc	1	13,786	83024190
	Total Set							36,670
	TopLine Grant SD Set Low Profile 10 feet with Silent System							
	9199839	9288889	Single Track 10 feet	1	Pc	1	15,748	83024190
	9203725	9203725	Low profile Hardware Set	1	Set	1	25,053	83024190
	9235608	9235608	Silent System SD	1	Pc	1	13,786	83024190
	Total Set							54,587
	TopLine Grant SD Set Standard 12 feet with Silent System							
	9199840	9288890	Single Track 12 feet	1	Pc	1	18,897	83024190
	9191124	9191124	Standard Hardware Set	1	Set	1	7,136	83024190
	9235608	9235608	Silent System SD	1	Pc	1	13,786	83024190
	Total Set							38,819
	TopLine Grant SD Set Low Profile 12 feet with Silent System							
	9199840	9288890	Single Track 12 feet	1	Pc	1	18,897	83024190
	9203725	9203725	Low profile Hardware Set	1	Set	1	25,053	83024190
	9235608	9235608	Silent System SD	1	Pc	1	13,786	83024190
	Total Set							57,736
	Accessories							
	9203733	9203733	Front fascia (8 feet)	1	Pc	1	9,693	83024190
	9203751	9203751	Header mount Fascia Clip	1	Pc	1	1,109	83024190
	9202941	9202941	End cap without fascia	1	Pc	1	2,176	83024190

Product	Article No.	SAP	Item Description	Qty.	Unit	PU	MRP	HS Code
Grand HD for door weight 147 kg								
	TopLine Grant HD Set Standard 8 feet with Silent System							
	9201460	9288893	Single Track 8 feet	1	Pc	1	12,776	83024190
	9191125	9191125	Standard Hardware Set	1	Set	1	7,879	83024190
	9235621	9235621	Silent System HD	1	Pc	1	16,575	83024190
			Total Set				37,230	
	TopLine Grant HD Set Low Profile 8 feet with Silent System							
	9201460	9288893	Single Track 8 feet	1	Pc	1	12,776	83024190
	9203729	9203729	Low profile Hardware Set	1	Set	1	25,072	83024190
	9235621	9235621	Silent System HD	1	Pc	1	16,575	83024190
			Total Set				54,423	
	TopLine Grant HD Set Standard 10 feet with Silent System							
	9201461	9288894	Single Track 10 feet	1	Pc	1	14,472	83024190
	9191125	9191125	Standard Hardware Set	1	Set	1	7,879	83024190
	9235621	9235621	Silent System HD	1	Pc	1	16,575	83024190
			Total Set				38,926	
	TopLine Grant HD Set Low Profile 10 feet with Silent System							
	9201461	9288894	Single Track 10 feet	1	Pc	1	14,472	83024190
	9203729	9203729	Low profile Hardware Set	1	Set	1	25,072	83024190
	9235621	9235621	Silent System HD	1	Pc	1	16,575	83024190
			Total Set				56,119	
	TopLine Grant HD Set Standard 12 feet with Silent System							
	9201462	9288895	Single Track 12 feet	1	Pc	1	17,349	83024190
	9191125	9191125	Standard Hardware Set	1	Set	1	7,879	83024190
	9235621	9235621	Silent System HD	1	Pc	1	16,575	83024190
			Total Set				41,803	
	TopLine Grant HD Set Low Profile 12 feet with Silent System							
	9201462	9288895	Single Track 12 feet	1	Pc	1	17,349	83024190
	9203729	9203729	Low profile Hardware Set	1	Set	1	25,072	83024190
	9235621	9235621	Silent System HD	1	Pc	1	16,575	83024190
			Total Set				58,996	
	Accessories							
	9203733	9203733	Front fascia (8 feet)	1	Pc	1	9,693	83024190
	9203751	9203751	Header mount Fascia Clip	1	Pc	1	1,109	83024190
	9202942	9202942	End cap without fascia	1	Pc	1	1,990	83024190

Product	Article No.	SAP	Item Description	Qty.	Unit	PU	MRP	HS Code
Grand XHD for door weight 227 kg								



TopLine Grant XHD Set Standard 12 feet without Silent System								
9199513	9288887		Single Track 12 feet	1	Pc	1	32,140	83024190
9191126	9191126		Standard Hardware Set	1	Set	1	15,468	83024190
			Total Set				47,608	



Quadro



KA Telescopic Runner

Drawer Runners

▸ Quadro



Product	Article No.	SAP	Item Description	Qty.	Unit	PU	MRP	HS Code
	Quadro- 25 Partial Extension 25 Kg							
	72904.S	9243213	250 mm with catches	1	Set	10	1,020	83021090
	72905.S	9243214	300 mm with catches	1	Set	10	764	83021090
	73210.S	9243215	350 mm with catches	1	Set	10	805	83021090
	73211.S	9243216	400 mm with catches	1	Set	10	844	83021090
	73212.S	9243217	450 mm with catches	1	Set	10	884	83021090
	33687.S	9243218	500 mm with catches	1	Set	10	923	83021090
	73214.S	9243219	550 mm with catches	1	Set	10	964	83021090
	Quadro-25 Partial Extension with Silent System 25 Kg							
	9135931.S	9243222	250 mm with catches	1	Set	10	1,234	83021090
	9135933.S	9243223	300 mm with catches	1	Set	10	1,234	83021090
	9135935.S	9243224	350 mm with catches	1	Set	10	1,270	83021090
	9135937.S	9243225	400 mm with catches	1	Set	10	1,309	83021090
	9135939.S	9243226	450 mm with catches	1	Set	10	1,346	83021090
	9135941.S	9243227	500 mm with catches	1	Set	10	1,383	83021090
	9135943.S	9243228	550 mm with catches	1	Set	10	1,490	83021090
	Quadro-V6 Full Extension 30 Kg with Silent System							
	45285.S	9243229	300 mm with catches	1	Set	10	2,153	83024200
	45287.S	9243230	350 mm with catches	1	Set	10	2,153	83024200
	45289.S	9243231	400 mm with catches	1	Set	10	2,340	83024200
	45291.S	9243232	450 mm with catches	1	Set	10	2,433	83024200
	45293.S	9243233	500 mm with catches	1	Set	10	2,526	83024200
	45295.S	9243234	550 mm with catches	1	Set	10	2,715	83024200
	45297.S	9243235	600 mm with catches	1	Set	10	2,995	83024200
	Quadro 25 Partial Extension with P20 25 Kg							
	9135958.S	9243236	300 mm with catches	1	Set	10	1,307	83021090
	9135960.S	9243237	350 mm with catches	1	Set	10	1,383	83021090
	9135962.S	9243238	400 mm with catches	1	Set	10	1,459	83021090
	9135964.S	9243239	450 mm with catches	1	Set	10	1,533	83021090
	9135966.S	9243240	500 mm with catches	1	Set	10	1,646	83021090
	Quadro V6 Full Extension with P20 30 Kg							
	9135984.S	9243241	250 mm with catches	1	Set	10	2,253	83021090
	9135985.S	9243242	300 mm with catches	1	Set	10	2,253	83021090
	9135987.S	9243243	350 mm with catches	1	Set	10	2,417	83021090
	9135989.S	9243244	400 mm with catches	1	Set	10	2,543	83021090
	9135991.S	9243245	450 mm with catches	1	Set	10	2,666	83021090
	9135993.S	9243246	500 mm with catches	1	Set	10	2,870	83021090
	9135995.S	9243247	550 mm with catches	1	Set	10	3,078	83021090
	Quadro Catches for wooden drawers							
	9144830	9144830	Left	1	Pc	10	57	39263000
	9144841	9144841	Right	1	Pc	10	57	39263000

Drawer Runners

► KA



Product	Article No.	SAP	Article No.	SAP	Item Description	Qty.	Unit	PU	MRP	HS Code	
	KA 5632 45 kg Zinc / Black										
	Zinc		Black								
	9293321	9293321	9293322	9293322	200 mm	1	Set	10	309	83024200	
	73276	9215435	44916	9215445	250 mm	1	Set	10	309	83024200	
	73277	9215436	44915	9215446	300 mm	1	Set	10	329	83024200	
	73278	9215437	44914	9215447	350 mm	1	Set	10	349	83024200	
	73279	9209240	44913	9215448	400 mm	1	Set	10	369	83024200	
	73280	9209239	44912	9215449	450 mm	1	Set	10	389	83024200	
	73281	9193319	44911	9215450	500 mm	1	Set	10	399	83024200	
	73282	9215441	44909	9215451	550 mm	1	Set	10	449	83024200	
	73283	9215442	44908	9215452	600 mm	1	Set	10	499	83024200	
	73284	9215443	44907	9215453	650 mm	1	Set	10	599	83024200	
	41355	9215444	44906	9215454	700 mm	1	Set	10	699	83024200	
		KA 4532, 35 kg Silent System / P20 Zinc									
Silent System		Push To Open									
9114271		9114271	9114281	9114281	300 mm	1	Set	10	937	83024200	
9114273		9114273	9114282	9114282	350 mm	1	Set	10	971	83024200	
9114274		9114274	9114283	9114283	400 mm	1	Set	10	1,005	83024200	
9114275		9114275	9114284	9114284	450 mm	1	Set	10	1,022	83024200	
9114276		9114276	9114285	9114285	500 mm	1	Set	10	1,039	83024200	
9114277		9114277	9114286	9114286	550 mm	1	Set	10	1,091	83024200	
9114278		9114278	9114288	9114288	600 mm	1	Set	10	1,176	83024200	
9114279		9114279	9114289	9114289	650 mm	1	Set	10	1,262	83024200	
9114280		9114280	9114290	9114290	700 mm	1	Set	10	1,347	83024200	
	KA 4620 90 Kg										
	41392	41392			400 mm	1	Set	5	1,419	83024200	
	41393	41393			450 mm	1	Set	5	1,419	83024200	
	41394	41394			500 mm	1	Set	5	1,577	83024200	
	41395	41395			550 mm	1	Set	5	1,595	83024200	
	41396	41396			600 mm	1	Set	5	1,734	83024200	
	41397	41397			650 mm	1	Set	5	2,177	83024200	
	41398	41398			700 mm	1	Set	5	2,358	83024200	

Drawer Runners

► KA / FR



Product	Article No.	SAP	Item Description	Qty.	Unit	PU	MRP	HS Code
	KA 3320 136 Kg							
	73296	9263137	760 mm	1	Set	5	8,153	83024200
	41367	9263138	810 mm	1	Set	3	8,736	83024200
	41368	9263139	860 mm	1	Set	3	9,318	83024200
	41369	9263140	910 mm	1	Set	3	9,706	83024200
	FR 302, 20 kg with stop control							
	75993	75993	250 mm	1	Set	20	95	83024200
	75994	1083317	300 mm	1	Set	20	103	83024200
	75995	1083318	350 mm	1	Set	20	115	83024200
	75996	1083319	400 mm	1	Set	20	129	83024200
	75997	1083320	450 mm	1	Set	20	143	83024200
	13089	1083321	500 mm	1	Set	20	157	83024200
	9006351	9006351	550 mm	1	Set	20	173	83024200
	KA 5740, 14 kg per shutter							
	41371	41371	300 mm	1	Set	1	1,065	83024200
	41372	41372	350 mm	1	Set	1	1,282	83024200
	41373	41373	400 mm	1	Set	1	1,356	83024200
	41374	41374	450 mm	1	Set	1	1,409	83024200
	41375	41375	500 mm	1	Set	1	1,478	83024200
	41376	41376	550 mm	1	Set	1	1,536	83024200
	41377	41377	600 mm	1	Set	1	1,605	83024200
	41378	41378	650 mm	1	Set	1	1,517	83024200
	41379	41379	700 mm	1	Set	1	1,737	83024200
	KA 5740 Accessory Kit							
	9079526	9079526	KA5740 Accessory Kit	1	Pc	1	415	83024200
	60832	9090098	Face frame Hinge with spring system	1	Pc	10	813	83021000



Drawer System MultiTech

► White



Product	Article No.	SAP	Item Description	Qty.	Unit	PU	MRP	HS Code
MultiTech- H 86 mm Side profile								
	9127881	9127881	Multitech 86x400 White	1	Set	10	737	94039010
	9127885	9127885	Multitech 86x500 White	1	Set	10	849	94039010
MultiTech- H 118 mm Side profile								
	9127895	9127895	Multitech 118x400 White	1	Set	10	871	94039010
	9127899	9127899	Multitech 118x500 White	1	Set	10	921	94039010
Drawer front connector for side profile								
	54997	9193173	Drawer front connector for side profile	1	Pc	20	77	83024200
Longitudinal Railing for PNP application								
	51426	51426	Lengthwise railing 400 mm White	1	Set	10	510	73269098
	51483	51483	Lengthwise railing 500 mm White	1	Set	10	329	83024200
Silent System								
	9137935	9137935	Silent System soft closure	1	Set	1	636	39263000
Anti Tilt Locking								
	51498	1910081	MultiTech locking device for anti-tilt	1	Pc	10	64	39263000







Drawer System InnoTech



Drawer System InnoTech

- ▶ Drawer, height 70 mm
- ▶ Silver







Product	Article No.	SAP	Item Description	Qty.	Unit	PU	HS Code
	InnoTech- 350 mm (30 Kg) Full Extn. Silent						
	1062015	9019693	Drawer side profile, L	1	Pc	1	94039010
	1062016	9019694	Drawer side profile, R	1	Pc	1	94039010
	1065191	1065191	Screw-On Front Connector	2	Pc	2	39263000
	45310-L	9126554	Quadro-V6	1	Pc	1	83024200
	45310-R	9126555	Quadro-V6	1	Pc	1	83024200
	1062501	1062501	Rear panel Connector, L	1	Pc	1	83024200
	1062502	1062502	Rear panel Connector, R	1	Pc	1	83024200
	9194646	9194646	Cover Cap Grey	2	Pc	2	39269097
BOM-Code	9243083	Total Set	MRP: 4,456				83021090
	InnoTech- 420 mm (30 Kg) Full Extn. Silent						
	1062017	9015786	Drawer side profile, L	1	Pc	1	94039010
	1062018	9015787	Drawer side profile, R	1	Pc	1	94039010
	1065191	1065191	Screw-On Front Connector	2	Pc	2	39263000
	45311-L	9126558	Quadro-V6	1	Pc	1	83024200
	45311-R	9126559	Quadro-V6	1	Pc	1	83024200
	1062501	1062501	Rear panel Connector, L	1	Pc	1	83024200
	1062502	1062502	Rear panel Connector, R	1	Pc	1	83024200
	9194646	9194646	Cover Cap Hettich logo Grey Background	2	Pc	2	39269097
BOM-Code	9243084	Total Set	MRP: 4,456				83021090
	InnoTech- 470 mm (30 Kg) Full Extn. Silent						
	1062019	9015793	Drawer side profile, L	1	Pc	1	94039010
	1062020	9015794	Drawer side profile, R	1	Pc	1	94039010
	1065191	1065191	Screw-On Front Connector	2	Pc	2	39263000
	45312-L	9126556	Quadro-V6	1	Pc	1	83024200
	45312-R	9126557	Quadro-V6	1	Pc	1	83024200
	1062501	1062501	Rear panel Connector, L	1	Pc	1	83024200
	1062502	1062502	Rear panel Connector, R	1	Pc	1	83024200
	9194646	9194646	Cover Cap Grey	2	Pc	2	39269097
BOM-Code	9243085	Total Set	MRP: 4,040				83021090
	InnoTech- 520 mm (30 Kg) Full Extn. Silent						
	1062521	9015811	Drawer side profile, L	1	Pc	1	94039010
	1062522	9015812	Drawer side profile, R	1	Pc	1	94039010
	1065191	1065191	Screw-On Front Connector	2	Pc	2	39263000
	45313-L	9126562	Quadro-V6	1	Pc	1	83024200
	45313-R	9126563	Quadro-V6	1	Pc	1	83024200
	1062501	1062501	Rear panel Connector, L	1	Pc	1	83024200
	1062502	1062502	Rear panel Connector, R	1	Pc	1	83024200
	9194646	9194646	Cover Cap Grey	2	Pc	2	39269097
BOM-Code	9243086	Total Set	MRP: 4,251				83021090

Drawer System InnoTech

- ▶ Drawer, height 70 mm
- ▶ Silver



Product	Article No.	SAP	Item Description	Qty.	Unit	PU	HS Code
	InnoTech- 420 mm (50 Kg) Full Extn. Silent						
	1062017	9015786	Drawer side profile, L	1	Pc	1	94039010
	1062018	9015787	Drawer side profile, R	1	Pc	1	94039010
	1065191	1065191	Screw-On Front Connector	2	Pc	2	39263000
	48360-L	9102862	Quadro-V6+	1	Pc	1	83024200
	48360-R	9102864	Quadro-V6+	1	Pc	1	83024200
	1062501	1062501	Rear panel Connector, L	1	Pc	1	83024200
	1062502	1062502	Rear panel Connector, R	1	Pc	1	83024200
	9194646	9194646	Cover Cap Grey	2	Pc	2	39269097
	BOM-Code	9243087	Total Set	MRP: 5,286			
	InnoTech- 470 mm (50 Kg) Full Extn. Silent						
	1062019	9015793	Drawer side profile, L	1	Pc	1	94039010
	1062020	9015794	Drawer side profile, R	1	Pc	1	94039010
	1065191	1065191	Screw-On Front Connector	2	Pc	2	39263000
	48361-L	9133792	Quadro-V6+	1	Pc	1	83024200
	48361-R	9133793	Quadro-V6+	1	Pc	1	83024200
	1062501	1062501	Rear panel Connector, L	1	Pc	1	83024200
	1062502	1062502	Rear panel Connector, R	1	Pc	1	83024200
	9194646	9194646	Cover Cap Grey	2	Pc	2	39269097
	BOM-Code	9243088	Total Set	MRP: 4,872			
	InnoTech- 520 mm (50 Kg) Full Extn. Silent						
	1062521	9015811	Drawer side profile, L	1	Pc	1	94039010
	1062522	9015812	Drawer side profile, R	1	Pc	1	94039010
	1065191	1065191	Screw-On Front Connector	2	Pc	2	39263000
	48362-L	9102868	Quadro-V6+	1	Pc	1	83024200
	48362-R	9102870	Quadro-V6+	1	Pc	1	83024200
	1062501	1062501	Rear panel Connector, L	1	Pc	1	83024200
	1062502	1062502	Rear panel Connector, R	1	Pc	1	83024200
	9194646	9194646	Cover Cap Grey	2	Pc	2	39269097
	BOM-Code	9243089	Total Set	MRP: 5,079			
	InnoTech- 620 mm (50 Kg) Full Extn. Silent						
	1077781	1077781	Drawer side profile, L	1	Pc	1	94039010
	1077782	1077782	Drawer side profile, R	1	Pc	1	94039010
	1065191	1065191	Screw-On Front Connector	2	Pc	2	39263000
	40271-L	9126394	Quadro-V6+	1	Pc	1	83024200
	40271-R	9126395	Quadro-V6+	1	Pc	1	83024200
	1062501	1062501	Rear panel Connector, L	1	Pc	1	83024200
	1062502	1062502	Rear panel Connector, R	1	Pc	1	83024200
	9194646	9194646	Cover Cap Grey	2	Pc	2	39269097
	BOM-Code	9243090	Total Set	MRP: 5,697			

Drawer System InnoTech

- ▶ Pot & pan drawer with railing, height 144 mm
- ▶ Silver



Product	Article No.	SAP	Item Description	Qty.	Unit	PU	HS Code
	InnoTech- 350 mm (30 Kg) Full Extn. Silent						
	1062015	9019693	Drawer side profile H70 mm, L	1	Pc	1	94039010
	1062016	9019694	Drawer side profile H70 mm, R	1	Pc	1	94039010
	1065191	1065191	Screw-On Front Connector	2	Pc	2	39263000
	45310-L	9126554	Quadro-V6	1	Pc	1	83024200
	45310-R	9126555	Quadro-V6	1	Pc	1	83024200
	1070630	1070630	Longitudinal Railing	2	Pc	2	73269098
	9002503	9002503	Railing Connector	2	Pc	2	39269097
	9007355	9007355	Rear panel Connector 144 mm, L	1	Pc	1	83024200
	9007356	9007356	Rear panel Connector 144 mm, R	1	Pc	1	83024200
	9194646	9194646	Cover Cap Grey	2	Pc	2	39269097
BOM-Code	9243091	Total Set	MRP: 5,079				83021090
	InnoTech- 420 mm (30 Kg) Full Extn. Silent						
	1062017	9015786	Drawer side profile H70 mm, L	1	Pc	1	94039010
	1062018	9015787	Drawer side profile H70 mm, R	1	Pc	1	94039010
	1065191	1065191	Screw-On Front Connector	2	Pc	2	39263000
	45311-L	9126558	Quadro-V6	1	Pc	1	83024200
	45311-R	9126559	Quadro-V6	1	Pc	1	83024200
	1063675	1063675	Longitudinal Railing	2	Pc	2	73269098
	9002503	9002503	Railing Connector	2	Pc	2	39269097
	9007355	9007355	Rear panel Connector 144 mm, L	1	Pc	1	83024200
	9007356	9007356	Rear panel Connector 144 mm, R	1	Pc	1	83024200
	9194646	9194646	Cover Cap Grey	2	Pc	2	39269097
BOM-Code	9243092	Total Set	MRP: 5,079				83021090
	InnoTech- 470 mm (30 Kg) Full Extn. Silent						
	1062019	9015793	Drawer side profile H70 mm, L	1	Pc	1	94039010
	1062020	9015794	Drawer side profile H70 mm, R	1	Pc	1	94039010
	1065191	1065191	Screw-On Front Connector	2	Pc	2	39263000
	45312-L	9126556	Quadro-V6	1	Pc	1	83024200
	45312-R	9126557	Quadro-V6	1	Pc	1	83024200
	1062394	1062394	Longitudinal Railing	2	Pc	2	83024200
	9002503	9002503	Railing Connector	2	Pc	2	39269097
	9007355	9007355	Rear panel Connector 144 mm, L	1	Pc	1	83024200
	9007356	9007356	Rear panel Connector 144 mm, R	1	Pc	1	83024200
	9194646	9194646	Cover Cap Grey	2	Pc	2	39269097
BOM-Code	9243093	Total Set	MRP: 4,663				83021090
	InnoTech- 520 mm (30 Kg) Full Extn. Silent						
	1062521	9015811	Drawer side profile H70 mm, L	1	Pc	1	94039010
	1062522	9015812	Drawer side profile H70 mm, R	1	Pc	1	94039010
	1065191	1065191	Screw-On Front Connector	2	Pc	2	39263000
	45313-L	9126562	Quadro-V6	1	Pc	1	83024200
	45313-R	9126563	Quadro-V6	1	Pc	1	83024200
	1063677	1063677	Longitudinal Railing	2	Pc	2	73269098
	9002503	9002503	Railing Connector	2	Pc	2	39269097
	9007355	9007355	Rear panel Connector 144 mm, L	1	Pc	1	83024200
	9007356	9007356	Rear panel Connector 144 mm, R	1	Pc	1	83024200
	9194646	9194646	Cover Cap Grey	2	Pc	2	39269097
BOM-Code	9243094	Total Set	MRP: 4,874				83021090

Drawer System InnoTech

- ▶ Pot & pan drawer with railing, height 144 mm
- ▶ Silver



Product	Article No.	SAP	Item Description	Qty.	Unit	PU	HS Code
	InnoTech- 420 mm (50 Kg) Full Extn.Silent						
	1062017	9015786	Drawer side profile H70 mm, L	1	Pc	1	94039010
	1062018	9015787	Drawer side profile H70 mm, R	1	Pc	1	94039010
	1065191	1065191	Screw-On Front Connector	2	Pc	2	39263000
	48360-L	9102862	Quadro-V6+	1	Pc	1	83024200
	48360-R	9102864	Quadro-V6+	1	Pc	1	83024200
	1063675	1063675	Longitudinal Railing	2	Pc	2	73269098
	9002503	9002503	Railing Connector	2	Pc	2	39269097
	9007355	9007355	Rear panel Connector 144 mm, L	1	Pc	1	83024200
	9007356	9007356	Rear panel Connector 144 mm, R	1	Pc	1	83024200
	9194646	9194646	Cover Cap Grey	2	Pc	2	39269097
BOM-Code	9243095	Total Set	MRP: 5,909				83021090
	InnoTech- 470 mm (50 Kg) Full Extn. Silent						
	1062019	9015793	Drawer side profile H70 mm, L	1	Pc	1	94039010
	1062020	9015794	Drawer side profile H70 mm, R	1	Pc	1	94039010
	1065191	1065191	Screw-On Front Connector	2	Pc	2	39263000
	48361-L	9133792	Quadro-V6+	1	Pc	1	83024200
	48361-R	9133793	Quadro-V6+	1	Pc	1	83024200
	1062394	1062394	Longitudinal Railing	2	Pc	2	73269098
	9002503	9002503	Railing Connector	2	Pc	2	39269097
	9007355	9007355	Rear panel Connector 144 mm, L	1	Pc	1	83024200
	9007356	9007356	Rear panel Connector 144 mm, R	1	Pc	1	83024200
	9194646	9194646	Cover Cap Grey	2	Pc	2	39269097
BOM-Code	9243096	Total Set	MRP: 5,495				83021090
	InnoTech- 520 mm (50 Kg) Full Extn. Silent						
	1062521	9015811	Drawer side profile H70 mm, L	1	Pc	1	94039010
	1062522	9015812	Drawer side profile H70 mm, R	1	Pc	1	94039010
	1065191	1065191	Screw-On Front Connector	2	Pc	2	39263000
	48362-L	9102868	Quadro-V6+	1	Pc	1	83024200
	48362-R	9102870	Quadro-V6+	1	Pc	1	83024200
	1063677	1063677	Longitudinal Railing	2	Pc	2	73269098
	9002503	9002503	Railing Connector	2	Pc	2	39269097
	9007355	9007355	Rear panel Connector 144 mm, L	1	Pc	1	83024200
	9007356	9007356	Rear panel Connector 144 mm, R	1	Pc	1	83024200
	9194646	9194646	Cover Cap Grey	2	Pc	2	39269097
BOM-Code	9243097	Total Set	MRP: 5,702				83021090
	InnoTech- 620 mm (50 Kg) Full Extn. Silent						
	1077781	1077781	Drawer side profile H70 mm, L	1	Pc	1	94039010
	1077782	1077782	Drawer side profile H70 mm, R	1	Pc	1	94039010
	1065191	1065191	Screw-On Front Connector	2	Pc	2	39263000
	40271-L	9126394	Quadro-V6+	1	Pc	1	83024200
	40271-R	9126395	Quadro-V6+	1	Pc	1	83024200
	1077931	1077931	Longitudinal Railing	2	Pc	2	73269098
	9002503	9002503	Railing Connector	2	Pc	2	39269097
	9007355	9007355	Rear panel Connector 144 mm, L	1	Pc	1	83024200
	9007356	9007356	Rear panel Connector 144 mm, R	1	Pc	1	83024200
	9194646	9194646	Cover Cap Grey	2	Pc	2	39269097
BOM-Code	9243098	Total Set	MRP: 6,320				83021090

Drawer System InnoTech

- ▶ Internal drawer 70 mm & 144 mm, 30 Kg, Drawer, height 70 / 144 mm
- ▶ Silver



Product	Article No.	SAP	Item Description	Qty.	Unit	PU	MRP	HS Code
Internal InnoTech 100- 470 mm (30 Kg) Full Extn. Silent. Alu Front								
	1062019	1062019	Drawer side profile, L	1	Pc	1	689	94039010
	1062020	1062020	Drawer side profile, R	1	Pc	1	689	94039010
	45312-L	45312-L	Quadro-V6	1	Pc	1	1,106	83024200
	45312-R	45312-R	Quadro-V6	1	Pc	1	1,106	83024200
	1062501	1062501	Rear panel Connector, L	1	Pc	1	205	83024200
	1062502	1062502	Rear panel Connector, R	1	Pc	1	205	83024200
	9194646	9194646	Cover Cap Grey	2	Pc	2	28	39269097
	9104108	9104108	Aluminium front 2000 mm	1	Pc	1	7,120	76041090
	9104107	9104107	Connector for aluminium front	1	Pc	1	465	39269097

Product	Article No.	SAP	Item Description	Qty.	Unit	PU	MRP	HS Code
Internal Pot & Pan InnoTech 100- 470 mm (30 Kg) Full Extn. Silent. Aluminium Front								
	1062019	9015793	Drawer side profile, L	1	Pc	1	689	94039010
	1062020	9015794	Drawer side profile, R	1	Pc	1	689	94039010
	45312-L	9126556	Quadro-V6	1	Set	1	1,106	83024200
	45312-R	9126557	Quadro-V6	1	Set	1	1,106	83024200
	9194646	9194646	Cover Cap Grey	2	Pc	2	28	39269097
	9086205	9086205	Aluminum Pot and Pan Front 600 mm 144 H	1	Pc	20	3599	94039010
	1062394	1062394	Innotech Gallery, 470 mm (Silver)	2	Pc	2	524	83024200
	9007355	9007355	Rear panel Connector 144 mm, L	1	Pc	1	234	83024200
	9007356	9007356	Rear panel Connector 144 mm, R	1	Pc	1	234	83024200
	9104108	9104108	Aluminium front 2000 mm	1	Pc	1	7,120	76041090
	1074009	1074009	Railing for aluminium front	1	Pc	1	933	73063011
	9104118	9104118	Corner Connector H144 mm, Set Both L & R	1	Set	1	953	39269097









Product	Article No.	SAP	Item Description	Qty.	Unit	PU	MRP	HS Code
InnoTech Silver- 470 mm (30 Kg) Part Extn. Silent								
	1062019	9015793	Drawer side profile, L	1	Pc	1		94039010
	1062020	9015794	Drawer side profile, R	1	Pc	1		94039010
	1065191	1065191	Screw-On Front Connector	2	Pc	2		39263000
	9159027	9159027	Quadro 25 - L	1	Pc	1		83024200
	9159028	9159028	Quadro 25 - R	1	Pc	1		83024200
	1062501	1062501	Rear panel Connector, L	1	Pc	1		83024200
	1062502	1062502	Rear panel Connector, R	1	Pc	1		83024200
	9194646	9194646	Cover Cap Grey	2	Pc	2		39269097
BOM-Code	9243102	Total Set					MRP: 3,314	83021090





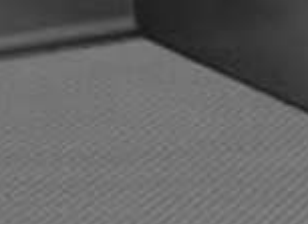

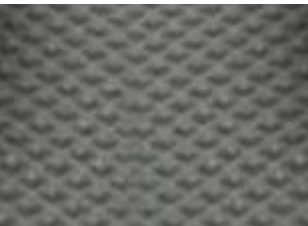
Product	Article No.	SAP	Item Description	Qty.	Unit	PU	MRP	HS Code
InnoTech Silver, Pot & Pan- 470 mm (30 Kg) Part Extn. Silent								
	1062019	9015793	Drawer side profile, L	1	Pc	1		94039010
	1062020	9015794	Drawer side profile, R	1	Pc	1		94039010
	1065191	1065191	Screw-On Front Connector	2	Pc	2		39263000
	9159027	9159027	Quadro 25 - L	1	Pc	1		83024200
	9159028	9159028	Quadro 25 - R	1	Pc	1		83024200
	1062394	1062394	Longitudinal Railing	2	Pc	2		83024200
	9002503	9002503	Railing Connector	2	Pc	2		39269097
	9007355	9007355	Rear panel Connector 144mm, L	1	Pc	1		83024200
	9007356	9007356	Rear panel Connector 144mm, R	1	Pc	1		83024200
	9194646	9194646	Cover Cap Grey	2	Pc	2		39269097
	BOM-Code	9243103	Total Set					MRP: 3,938

Drawer System InnoTech

► Accessories









Product	Article No.	SAP	Item Description	Qty.	Unit	PU	MRP	HS Code	
	InnoTech TopSide								
	9004315	9004315	H144/470 Silver	1	Set	1	1,366	94039010	
	9005411	9005411	H144/520 Silver	1	Set	1	1,190	83024200	
	9079648	9079648	Universal Adapter Topside H144 Grey	1	Set	1	723	94039010	
	InnoTech DesignSide								
	9100889	9100889	Grey, Float Glass+Adapters 470 mm	1	Set	1	2,934	70200080	
	9100890	9100890	Grey, Float Glass+Adapters 520 mm	1	Set	1	3,114	94039000	
	9100878	9100878	Innotech Adapter for DesignSide	1	Set	1	1,523	70200080	
	InnoTech Rear Panel, Silver								
	1061904	1061904	70mm / 450 mm	1	Pc	1	480	94039010	
	1061907	1061907	70mm / 600 mm	1	Pc	1	445	94039010	
	1062961	1062961	70mm / 900 mm	1	Pc	1	793	94039010	
	9004069	9004069	144mm / 450 mm	1	Pc	1	955	94039010	
	9004072	9004072	144mm / 600 mm	1	Pc	1	886	94039010	
	9004075	9004075	144mm / 900 mm	1	Pc	1	1,369	94039010	
	InnoTech Design Profile (Chrome)								
	9068242	9068242	Design Rail 470 mm	1	Pc	20	329	39169090	
	9068244	9068244	Design Rail 520 mm	1	Pc	20	355	39169090	
Anti-slip mat for IntoTech									
	Anti-slip mat - Classic (5 m roll)								
	9209533	9209533	Anti-slip Mat 470 Silver	1	Pc	1	6,706	39269097	
	9209536	9209536	Anti-slip Mat 520 Silver	1	Pc	1	6,829	39269097	
	9209568	9209568	Anti-slip Mat 620 Silver	1	Pc	1	9,251	39269097	
	9209580	9209580	Anti-slip Mat 500 Anthracite	1	Pc	1	6,772	39269097	
	Anti-slip mat - Hard Chequered (5 m roll)								
	9290039	9290039	Anti slip mat W5000 D470 CA930 Silver	1	Pc	1	1,540	39181090	
	9290040	9290040	Anti slip mat W5000 D520 CA930 Silver	1	Pc	1	1,709	39181090	
	9290051	9290051	Anti slip mat W5000 D470 CA930 Anthracite	1	Pc	1	1,540	39181090	
	9290052	9290052	Anti slip mat W5000 D520 CA930 Anthracite	1	Pc	1	1,709	39181090	
	Anti-slip mat - Soft Fine Chequered (5 m roll)								
	9290043	9290043	Anti slip mat W5000 D470 CA009 Silver	1	Pc	1	3,458	39181090	
	9290044	9290044	Anti slip mat W5000 D520 CA009 Silver	1	Pc	1	3,828	39181090	
	9290055	9290055	Anti slip mat W5000 D470 CA009 Anthracite	1	Pc	1	3,458	39181090	
	9290056	9290056	Anti slip mat W5000 D520 CA009 Anthracite	1	Pc	1	3,828	39181090	
	Anti-slip mat- Big Dots (5 m roll)								
	9290047	9290047	Anti slip mat W5000 D470 CA006 Silver	1	Pc	1	3,302	39181090	
	9290048	9290048	Anti slip mat W5000 D520 CA006 Silver	1	Pc	1	3,663	39181090	
	9290059	9290059	Anti slip mat W5000 D470 CA006 Anthracite	1	Pc	1	3,302	39181090	
	9290060	9290060	Anti slip mat W5000 D520 CA006 Anthracite	1	Pc	1	3,663	39181090	

Product	Article No.	SAP	Item Description	Qty.	Unit	PU	MRP	HS Code	
	OrgaTray 440 Trimmable (Fixed Partition Cutlery)								
	9194924	9194924	Tray width 501-600 mm, Depth 370 - 440 mm	1	Pc	1	679	39249000	
	9194934	9194934	Tray width 351-400 mm, Depth 441- 520 mm	1	Pc	1	511	39249000	
	9194935	9194935	Tray width 401-450 mm, Depth 441- 520 mm	1	Pc	1	540	39249000	
	9194936	9194936	Tray width 451-500 mm, Depth 441- 520 mm	1	Pc	1	591	39249000	
	9194937	9194937	Tray width 501-600 mm, Depth 441- 520 mm	1	Pc	1	704	39249000	
	9194938	9194938	Tray width 601-700 mm, Depth 441- 520 mm	1	Pc	1	2,750	39249000	
	9194939	9194939	Tray width 701-800 mm, Depth 441- 520 mm	1	Pc	1	1349	39249000	
9194940	9194940	Tray width 801-900 mm, Depth 441- 520 mm	1	Pc	1	1417	39249000		
	OrgaTray 560 (Adjustable Partition Cutlery)								
	13304	9002439	For 470 mm depth, cab width 450 mm	1	Set	1	1,809	39249000	
	13306	9002441	For 470 mm depth, cab width 600 mm	1	Set	1	2,126	39249000	
	13307	9005806	For 470 mm depth, cab width 800 mm	1	Set	1	4,054	39249000	
	13308	9004427	For 470 mm depth, cab width 900 mm	1	Set	1	4,106	39249000	
	13317	9005651	For 520 mm depth, cab width 600 mm	1	Set	1	2,235	39249000	
	13319	9005671	For 520 mm depth, cab width 900 mm	1	Set	1	4,458	39249000	
	OrgaTray 590 (Adjustable Partition Cutlery)								
	9194891	9194891	For 470 mm depth, cab width 600 mm	1	Set	1	1,789	39249000	
	9194893	9194893	For 470 mm depth, cab width 900 mm	1	Set	1	3,451	39249000	
	OrgaTray 490 (PVC Cutlery)								
	9207241	9207241	For 470 mm depth, for cab width ≥ 450 mm	1	Set	1	1,415	39249000	
	OrgaTray 610 (Powder Coated Steel Cutlery)								
	9194881	9194881	For 470 mm depth, for cab width ≥ 450 mm	1	Set	1	5,295	73239900	
	Orga Stripe Profile								
	9203466	9203466	Orga Profile 1100 mm Grey	1	Pc	1	401	39169090	
	9203469	9203469	Orga Clip Grey	1	Pc	1	77	39263000	
	OrgaFlag Advanced								
	9194869	9194869	For 470 mm depth, cab width 600 mm	1	Set	1	7,547	39249000	
	9194870	9194870	For 470 mm depth, cab width 900 mm	1	Set	1	10,545	39249000	
	9194872	9194872	For 520 mm depth, cab width 600 mm	1	Set	1	8,185	39249000	
	9194873	9194873	For 520 mm depth, cab width 900 mm	1	Set	1	11,502	39249000	

Drawer System InnoTech

► Internal Accessories



Product	Article No.	SAP	Item Description	Qty.	Unit	PU	MRP	HS Code
	Lengthwise railing for wooden rear panel (Add on kit)							
	1081333	1081333	470 mm	1	Set	8	589	73269098
	1081335	1081335	520 mm	1	Set	8	707	73269098
	1081337	1081337	620 mm	1	Set	1	1,230	73269098
	9002503	9002503	Front connector with Expanding socket	2	Pc	2	30	39269097
	Crosswise railing for Pot & Pan drawer							
	10016	10016	Double railing kit 470 mm	1	Set	1	2,153	73269098
	10017	10017	Double railing kit 520 mm	1	Set	1	2,372	94039010
	77924	1074009	Crosswise railing 1100 mm Silver	1	Pc	1	933	73063011
	77925	1070632	Mount for crosswise railing	1	Pc	20	27	39263000
	9014651	9014651	IT Orgastore flag gray	1	Pc	20	297	39269097
	Plate Rack, for storage of plates up to 29 cm diameter							
	9132496	9132496	Plate rack white	1	Pc	1	2,149	39263000
	9132497	9132497	Set of end caps white	1	Set	1	1,206	39263000
	9132521	9132521	Plate rack Silver	1	Pc	1	2,219	39263000
	9132522	9132522	Set of end caps Silver	1	Set	1	1,245	39263000
Innotech Drawer Side Profile								
	Finish : Silver							
	1062015	9019693	InnoTech- 350 mm-Drawer side profile, L -Silver	1	Pc	1	773	94039010
	1062016	9019694	InnoTech- 350 mm-Drawer side profile, R -Silver	1	Pc	1	773	94039010
	1062017	9015786	InnoTech- 420 mm-Drawer side profile, L -Silver	1	Pc	1	782	94039010
	1062018	9015787	InnoTech- 420 mm-Drawer side profile, R -Silver	1	Pc	1	782	94039010
	1062019	9015793	InnoTech- 470 mm-Drawer side profile, L -Silver	1	Pc	1	689	94039010
	1062020	9015794	InnoTech- 470 mm-Drawer side profile, R -Silver	1	Pc	1	689	94039010
	1062521	9015811	InnoTech- 520 mm-Drawer side profile, L -Silver	1	Pc	1	722	94039010
	1062522	9015812	InnoTech- 520 mm-Drawer side profile, R -Silver	1	Pc	1	722	94039010
	1077781	1077781	InnoTech- 620 mm-Drawer side profile, L -Silver	1	Pc	1	868	94039010
1077782	1077782	InnoTech- 620 mm-Drawer side profile, R -Silver	1	Pc	1	868	94039010	
Longitudinal railing								
	Finish : Silver							
	1070630	1070630	InnoTech- 350 mm-Longitudinal Railing -Silver	1	Pc	1	262	73269098
	1063675	1063675	InnoTech- 420 mm-Longitudinal Railing -Silver	1	Pc	1	262	73269098
	1062394	1062394	InnoTech- 470 mm-Longitudinal Railing -Silver	1	Pc	1	262	83024200
	1063677	1063677	InnoTech- 520 mm-Longitudinal Railing -Silver	1	Pc	1	267	73269098
	1077931	1077931	InnoTech- 620 mm-Longitudinal Railing -Silver	1	Pc	1	262	73269098
	Connector							
	9002503	9002503	Railing Connector	2	Pc	2	30	39269097
	1065191	1065191	Screw-On Front Connector	2	Pc	2	40	39263000

Drawer System InnoTech

► Internal Accessories



Product	Article No.	SAP	Item Description	Qty.	Unit	PU	MRP	HS Code
Rear Panel Connector								
	Finish : Silver							
	1062501	1062501	Rear panel Connector 70 mm, L -Silver	1	Pc	1	205	83024200
	1062502	1062502	Rear panel Connector 70 mm, R -Silver	1	Pc	1	205	83024200
	9007355	9007355	Rear panel Connector 144 mm, L -Silver	1	Pc	1	234	83024200
	9007356	9007356	Rear panel Connector 144 mm, R -Silver	1	Pc	1	234	83024200
Cover Cap								
	9194646	9194646	Cover Cap Grey	2	Pc	2	28	39269097
Quadro V6								
	45310-L	9126554	Innotech 350 mm - Quadro-V6	1	Pc	1	1,222	83024200
	45310-R	9126555	Innotech 350 mm - Quadro-V6	1	Pc	1	1,222	83024200
	45311-L	9126558	InnoTech- 420 mm - Quadro-V6	1	Pc	1	1,222	83024200
	45311-R	9126559	InnoTech- 420 mm - Quadro-V6	1	Pc	1	1,222	83024200
	45312-L	9126556	InnoTech- 470 mm - Quadro-V6	1	Pc	1	1,106	83024200
	45312-R	9126557	InnoTech- 470 mm - Quadro-V6	1	Pc	1	1,106	83024200
	45313-L	9126562	InnoTech- 520 mm - Quadro-V6	1	Pc	1	1,165	83024200
	45313-R	9126563	InnoTech- 520 mm - Quadro-V6	1	Pc	1	1,165	83024200
Quadro V6+								
	48360-L	9102862	InnoTech- 420 mm - Quadro-V6+	1	Pc	1	1,628	83024200
	48360-R	9102864	InnoTech- 420 mm - Quadro-V6+	1	Pc	1	1,628	83024200
	48361-L	9133792	InnoTech- 470 mm - Quadro-V6+	1	Pc	1	1,514	83024200
	48361-R	9133793	InnoTech- 470 mm - Quadro-V6+	1	Pc	1	1,514	83024200
	48362-L	9102868	InnoTech- 520 mm - Quadro-V6+	1	Pc	1	1,578	83024200
	48362-R	9102870	InnoTech- 520 mm - Quadro-V6+	1	Pc	1	1,578	83024200
	40271-L	9126394	InnoTech- 620 mm - Quadro-V6+	1	Pc	1	1,748	83024200
	40271-R	9126395	InnoTech- 620 mm - Quadro-V6+	1	Pc	1	1,748	83024200
Partial Extension								
	9159027	9159027	InnoTech- 470 mm - Quadro 25 - L	1	Pc	1	753	83024200
	9159028	9159028	InnoTech- 470 mm - Quadro 25 - R	1	Pc	1	753	83024200
PTO Full Extension 30 Kg								
	9143499	9143499	InnoTech- 470 mm - Quadro V6 EB 9.5	1	Set	1	3,257	83024200
	9143500	9143500	InnoTech- 520 mm - Quadro V6 EB 9.5	1	Set	1	3,292	83024200



Drawer System ArciTech

► Drawer, height 94 & 186 mm



Product	Article No.	SAP	Item Description	Qty.	Unit	PU	HS Code
	ArciTech Silver 450 mm, Height 94 mm, 40 kg						
	9121205	9121205	Drawer side profile, L	1	Pc	1	94039010
	9121206	9121206	Drawer side profile, R	1	Pc	1	94039010
	9123005	9123005	Cover Cap	2	Pc	2	39269097
	9121827	9121827	Rear panel Connector, L	1	Pc	1	83024200
	9121828	9121828	Rear panel Connector, R	1	Pc	1	83024200
	9123011	9123011	Screw-On Front Connector	2	Pc	2	83024200
	9239283	9239283	Actro runner, L	1	Pc	1	83024200
	9239284	9239284	Actro runner, R	1	Pc	1	83024200
BOM-Code	9243114	Total Set				MRP: 5,579	83021090
	ArciTech Silver 500 mm, Height 94 mm, 40 kg						
	9121207	9121207	Drawer side profile, L	1	Pc	1	94039010
	9121208	9121208	Drawer side profile, R	1	Pc	1	94039010
	9123005	9123005	Cover Cap	2	Pc	2	39269097
	9121827	9121827	Rear panel Connector, L	1	Pc	1	83024200
	9121828	9121828	Rear panel Connector, R	1	Pc	1	83024200
	9123011	9123011	Screw-On Front Connector	2	Pc	2	83024200
	9239287	9239287	Actro runner, L	1	Pc	1	83024200
	9239288	9239288	Actro runner, R	1	Pc	1	83024200
BOM-Code	9243115	Total Set				MRP: 5,579	83021090
	ArciTech Silver 550 mm, Height 94 mm, 40 kg						
	9121209	9121209	Drawer side profile, L	1	Pc	1	94039010
	9121210	9121210	Drawer side profile, R	1	Pc	1	94039010
	9123005	9123005	Cover Cap	2	Pc	2	39269097
	9121827	9121827	Rear panel Connector, L	1	Pc	1	83024200
	9121828	9121828	Rear panel Connector, R	1	Pc	1	83024200
	9123011	9123011	Screw-On Front Connector	2	Pc	2	83024200
	9239293	9239293	Actro runner, L	1	Pc	1	83024200
	9239294	9239294	Actro runner, R	1	Pc	1	83024200
BOM-Code	9243116	Total Set				MRP: 5,804	83021090
	ArciTech Silver 450 mm, Height 94 mm, 60 kg						
	9121205	9121205	Drawer side profile, L	1	Pc	1	94039010
	9121206	9121206	Drawer side profile, R	1	Pc	1	94039010
	9123005	9123005	Cover Cap	2	Pc	2	39269097
	9121827	9121827	Rear panel Connector, L	1	Pc	1	83024200
	9121828	9121828	Rear panel Connector, R	1	Pc	1	83024200
	9123011	9123011	Screw-On Front Connector	2	Pc	2	83024200
	9239285	9239285	Actro runner, L	1	Pc	1	83024200
	9239286	9239286	Actro runner, R	1	Pc	1	83024200
BOM-Code	9243117	Total Set				MRP: 6,472	83021090

Drawer System ArciTech

► Drawer, height 94 & 186 mm







Product	Article No.	SAP	Item Description	Qty.	Unit	PU	HS Code
	ArciTech Silver 500 mm, Height 94 mm, 70 kg						
	9121207	9121207	Drawer side profile, L	1	Pc	1	94039010
	9121208	9121208	Drawer side profile, R	1	Pc	1	94039010
	9123005	9123005	Cover Cap	2	Pc	2	39269097
	9121827	9121827	Rear panel Connector, L	1	Pc	1	83024200
	9121828	9121828	Rear panel Connector, R	1	Pc	1	83024200
	9123011	9123011	Screw-On Front Connector	2	Pc	2	83024200
	9239289	9239289	Actro runner, L	1	Pc	1	83024200
	9239290	9239290	Actro runner, R	1	Pc	1	83024200
BOM-Code	9243118	Total Set				MRP: 6,472	83021090
	ArciTech Silver 550 mm, Height 94 mm, 60 kg						
	9121209	9121209	Drawer side profile, L	1	Pc	1	94039010
	9121210	9121210	Drawer side profile, R	1	Pc	1	94039010
	9123005	9123005	Cover Cap	2	Pc	2	39269097
	9121827	9121827	Rear panel Connector, L	1	Pc	1	83024200
	9121828	9121828	Rear panel Connector, R	1	Pc	1	83024200
	9123011	9123011	Screw-On Front Connector	2	Pc	2	83024200
	9239295	9239295	Actro runner, L	1	Pc	1	83024200
	9239296	9239296	Actro runner, R	1	Pc	1	83024200
BOM-Code	9243119	Total Set				MRP: 6,695	83021090
	ArciTech Silver 650 mm, Height 94 mm, 60 kg						
	9121211	9121211	Drawer side profile, L	1	Pc	1	94039010
	9121212	9121212	Drawer side profile, R	1	Pc	1	94039010
	9123005	9123005	Cover Cap	2	Pc	2	39269097
	9121827	9121827	Rear panel Connector, L	1	Pc	1	83024200
	9121828	9121828	Rear panel Connector, R	1	Pc	1	83024200
	9123011	9123011	Screw-On Front Connector	2	Pc	2	83024200
	9239301	9239301	Actro runner, L	1	Pc	1	83024200
	9239302	9239302	Actro runner, R	1	Pc	1	83024200
BOM-Code	9243120	Total Set				MRP: 7,143	83021090



Drawer System ArciTech

► Drawer, height 94 & 186 mm



Product	Article No.	SAP	Item Description	Qty.	Unit	PU	HS Code
	ArciTech Silver 550 mm, Height 94 mm, 80 kg						
	9121209	9121209	Drawer side profile, L	1	Pc	1	94039010
	9121210	9121210	Drawer side profile, R	1	Pc	1	94039010
	9123005	9123005	Cover Cap	2	Pc	2	39269097
	9121827	9121827	Rear panel Connector, L	1	Pc	1	83024200
	9121828	9121828	Rear panel Connector, R	1	Pc	1	83024200
	9123011	9123011	Screw-On Front Connector	2	Pc	2	83024200
	9239297	9239297	Actro runner, L	1	Pc	1	83024200
	9239298	9239298	Actro runner, R	1	Pc	1	83024200
BOM-Code	9243122	Total Set	MRP: 7,590				83021090
	ArciTech White 450 mm, Height 94 mm, 40 kg						
	9121247	9121247	Drawer side profile, L	1	Pc	1	94039010
	9121248	9121248	Drawer side profile, R	1	Pc	1	94039010
	9123006	9123006	Cover Cap	2	Pc	2	39269097
	9121829	9121829	Rear panel Connector, L	1	Pc	1	83024200
	9121830	9121830	Rear panel Connector, R	1	Pc	1	83024200
	9123011	9123011	Screw-On Front Connector	2	Pc	2	83024200
	9239283	9239283	Actro runner, L	1	Pc	1	83024200
	9239284	9239284	Actro runner, R	1	Pc	1	83024200
BOM-Code	9243124	Total Set	MRP: 5,804				83021090
	ArciTech White 500 mm, Height 94 mm, 40 kg						
	9121249	9121249	Drawer side profile, L	1	Pc	1	94039010
	9121250	9121250	Drawer side profile, R	1	Pc	1	94039010
	9123006	9123006	Cover Cap	2	Pc	2	39269097
	9121829	9121829	Rear panel Connector, L	1	Pc	1	83024200
	9121830	9121830	Rear panel Connector, R	1	Pc	1	83024200
	9123011	9123011	Screw-On Front Connector	2	Pc	2	83024200
	9239287	9239287	Actro runner, L	1	Pc	1	83024200
	9239288	9239288	Actro runner, R	1	Pc	1	83024200
BOM-Code	9243125	Total Set	MRP: 5,804				83021090
	ArciTech White 550 mm, Height 94 mm, 40 kg						
	9121251	9121251	Drawer side profile, L	1	Pc	1	94039010
	9121252	9121252	Drawer side profile, R	1	Pc	1	94039010
	9123006	9123006	Cover Cap	2	Pc	2	39269097
	9121829	9121829	Rear panel Connector, L	1	Pc	1	83024200
	9121830	9121830	Rear panel Connector, R	1	Pc	1	83024200
	9123011	9123011	Screw-On Front Connector	2	Pc	2	83024200
	9239293	9239293	Actro runner, L	1	Pc	1	83024200
	9239294	9239294	Actro runner, R	1	Pc	1	83024200
BOM-Code	9243126	Total Set	MRP: 6,030				83021090

Drawer System ArciTech

► Drawer, height 94 & 186 mm







Product	Article No.	SAP	Item Description	Qty.	Unit	PU	HS Code
	ArciTech White 450 mm, Height 94 mm, 60 kg						
	9121247	9121247	Drawer side profile, L	1	Pc	1	94039010
	9121248	9121248	Drawer side profile, R	1	Pc	1	94039010
	9123006	9123006	Cover Cap	2	Pc	2	39269097
	9121829	9121829	Rear panel Connector, L	1	Pc	1	83024200
	9121830	9121830	Rear panel Connector, R	1	Pc	1	83024200
	9123011	9123011	Screw-On Front Connector	2	Pc	2	83024200
	9239285	9239285	Actro runner, L	1	Pc	1	83024200
	9239286	9239286	Actro runner, R	1	Pc	1	83024200
BOM-Code	9243127	Total Set				MRP: 6,698	83021090
	ArciTech White 500 mm, Height 94 mm, 70 kg						
	9121249	9121249	Drawer side profile, L	1	Pc	1	94039010
	9121250	9121250	Drawer side profile, R	1	Pc	1	94039010
	9123006	9123006	Cover Cap	2	Pc	2	39269097
	9121829	9121829	Rear panel Connector, L	1	Pc	1	83024200
	9121830	9121830	Rear panel Connector, R	1	Pc	1	83024200
	9123011	9123011	Screw-On Front Connector	2	Pc	2	83024200
	9239289	9239289	Actro runner, L	1	Pc	1	83024200
	9239290	9239290	Actro runner, R	1	Pc	1	83024200
BOM-Code	9243128	Total Set				MRP: 6,698	83021090
	ArciTech White 550 mm, Height 94 mm, 60 kg						
	9121251	9121251	Drawer side profile, L	1	Pc	1	94039010
	9121252	9121252	Drawer side profile, R	1	Pc	1	94039010
	9123006	9123006	Cover Cap	2	Pc	2	39269097
	9121829	9121829	Rear panel Connector, L	1	Pc	1	83024200
	9121830	9121830	Rear panel Connector, R	1	Pc	1	83024200
	9123011	9123011	Screw-On Front Connector	2	Pc	2	83024200
	9239295	9239295	Actro runner, L	1	Pc	1	83024200
	9239296	9239296	Actro runner, R	1	Pc	1	83024200
BOM-Code	9243129	Total Set				MRP: 6,921	83021090



Drawer System ArciTech

► Drawer, height 94 & 186 mm



Product	Article No.	SAP	Item Description	Qty.	Unit	PU	HS Code
	ArciTech White 550 mm, Height 94 mm, 80 kg						
	9121251	9121251	Drawer side profile, L	1	Pc	1	94039010
	9121252	9121252	Drawer side profile, R	1	Pc	1	94039010
	9123006	9123006	Cover Cap	2	Pc	2	39269097
	9121829	9121829	Rear panel Connector, L	1	Pc	1	83024200
	9121830	9121830	Rear panel Connector, R	1	Pc	1	83024200
	9123011	9123011	Screw-On Front Connector	2	Pc	2	83024200
	9239297	9239297	Actro runner, L	1	Pc	1	83024200
	9239298	9239298	Actro runner, R	1	Pc	1	83024200
	BOM-Code	9243132	Total Set	MRP: 7,816			
	ArciTech Anthracite 450 mm, Height 94 mm, 40 kg						
	9121289	9121289	Drawer side profile, L	1	Pc	1	94039010
	9121290	9121290	Drawer side profile, R	1	Pc	1	94039010
	9123005	9123005	Cover Cap	2	Pc	2	39269097
	9121831	9121831	Rear panel Connector, L	1	Pc	1	83024200
	9121832	9121832	Rear panel Connector, R	1	Pc	1	83024200
	9123011	9123011	Screw-On Front Connector	2	Pc	2	83024200
	9239283	9239283	Actro runner, L	1	Pc	1	83024200
	9239284	9239284	Actro runner, R	1	Pc	1	83024200
	BOM-Code	9243134	Total Set	MRP: 5,804			
	ArciTech Anthracite 500 mm, Height 94 mm, 40 kg						
	9121291	9121291	Drawer side profile, L	1	Pc	1	94039010
	9121292	9121292	Drawer side profile, R	1	Pc	1	94039010
	9123005	9123005	Cover Cap	2	Pc	2	39269097
	9121831	9121831	Rear panel Connector, L	1	Pc	1	83024200
	9121832	9121832	Rear panel Connector, R	1	Pc	1	83024200
	9123011	9123011	Screw-On Front Connector	2	Pc	2	83024200
	9239287	9239287	Actro runner, L	1	Pc	1	83024200
	9239288	9239288	Actro runner, R	1	Pc	1	83024200
	BOM-Code	9243135	Total Set	MRP: 5,804			
	ArciTech Anthracite 550 mm, Height 94 mm, 40 kg						
	9121293	9121293	Drawer side profile, L	1	Pc	1	94039010
	9121294	9121294	Drawer side profile, R	1	Pc	1	94039010
	9123005	9123005	Cover Cap	2	Pc	2	39269097
	9121831	9121831	Rear panel Connector, L	1	Pc	1	83024200
	9121832	9121832	Rear panel Connector, R	1	Pc	1	83024200
	9123011	9123011	Screw-On Front Connector	2	Pc	2	83024200
	9239293	9239293	Actro runner, L	1	Pc	1	83024200
	9239294	9239294	Actro runner, R	1	Pc	1	83024200
	BOM-Code	9243136	Total Set	MRP: 6,028			

Drawer System ArciTech

► Drawer, height 94 & 186 mm







Product	Article No.	SAP	Item Description	Qty.	Unit	PU	HS Code
	ArciTech Anthracite 450 mm, Height 94 mm, 60 kg						
	9121289	9121289	Drawer side profile, L	1	Pc	1	94039010
	9121290	9121290	Drawer side profile, R	1	Pc	1	94039010
	9123005	9123005	Cover Cap	2	Pc	2	39269097
	9121831	9121831	Rear panel Connector, L	1	Pc	1	83024200
	9121832	9121832	Rear panel Connector, R	1	Pc	1	83024200
	9123011	9123011	Screw-On Front Connector	2	Pc	2	83024200
	9239285	9239285	Actro runner, L	1	Pc	1	83024200
	9239286	9239286	Actro runner, R	1	Pc	1	83024200
BOM-Code	9243137	Total Set	MRP: 6,698				83021090
	ArciTech Anthracite 500 mm, Height 94 mm, 70 kg						
	9121291	9121291	Drawer side profile, L	1	Pc	1	94039010
	9121292	9121292	Drawer side profile, R	1	Pc	1	94039010
	9123005	9123005	Cover Cap	2	Pc	2	39269097
	9121831	9121831	Rear panel Connector, L	1	Pc	1	83024200
	9121832	9121832	Rear panel Connector, R	1	Pc	1	83024200
	9123011	9123011	Screw-On Front Connector	2	Pc	2	83024200
	9239289	9239289	Actro runner, L	1	Pc	1	83024200
	9239290	9239290	Actro runner, R	1	Pc	1	83024200
BOM-Code	9243138	Total Set	MRP: 6,698				83021090
	ArciTech Anthracite 550 mm, Height 94 mm, 60 kg						
	9121293	9121293	Drawer side profile, L	1	Pc	1	94039010
	9121294	9121294	Drawer side profile, R	1	Pc	1	94039010
	9123005	9123005	Cover Cap	2	Pc	2	39269097
	9121831	9121831	Rear panel Connector, L	1	Pc	1	83024200
	9121832	9121832	Rear panel Connector, R	1	Pc	1	83024200
	9123011	9123011	Screw-On Front Connector	2	Pc	2	83024200
	9239295	9239295	Actro runner, L	1	Pc	1	83024200
	9239296	9239296	Actro runner, R	1	Pc	1	83024200
BOM-Code	9243139	Total Set	MRP: 6,920				83021090



Drawer System ArciTech

► Drawer, height 94 & 186 mm



Product	Article No.	SAP	Item Description	Qty.	Unit	PU	HS Code
	ArciTech Anthracite 550 mm, Height 94 mm, 80 kg						
	9121293	9121293	Drawer side profile, L	1	Pc	1	94039010
	9121294	9121294	Drawer side profile, R	1	Pc	1	94039010
	9123005	9123005	Cover Cap	2	Pc	2	39269097
	9121831	9121831	Rear panel Connector, L	1	Pc	1	83024200
	9121832	9121832	Rear panel Connector, R	1	Pc	1	83024200
	9123011	9123011	Screw-On Front Connector	2	Pc	2	83024200
	9239297	9239297	Actro runner, L	1	Pc	1	83024200
	9239298	9239298	Actro runner, R	1	Pc	1	83024200
	BOM-Code	9243142	Total Set	MRP: 7,813			
	ArciTech Silver 450 mm pot & pan with railing, Height 186 mm, 40 kg						
	9121205	9121205	Drawer side profile, L	1	Pc	1	94039010
	9121206	9121206	Drawer side profile, R	1	Pc	1	94039010
	9123005	9123005	Cover Cap	2	Pc	2	39269097
	9121843	9121843	Rear panel Connector, L	1	Pc	1	83024200
	9121844	9121844	Rear panel Connector, R	1	Pc	1	83024200
	9123011	9123011	Screw-On Front Connector	2	Pc	2	83024200
	9239283	9239283	Actro runner, L	1	Pc	1	83024200
	9239284	9239284	Actro runner, R	1	Pc	1	83024200
	9121993	9121993	Lengthwise Railing, L	1	Pc	1	73269098
	9121994	9121994	Lengthwise Railing, R	1	Pc	1	73269098
	9127011	9127011	Screw-On Railing Connector	2	Pc	2	39263000
BOM-Code	9243154	Total Set	MRP: 6,694				83021090
	ArciTech Silver 500 mm pot & pan with railing, Height 186 mm, 40 kg						
	9121207	9121207	Drawer side profile, L	1	Pc	1	94039010
	9121208	9121208	Drawer side profile, R	1	Pc	1	94039010
	9123005	9123005	Cover Cap	2	Pc	2	39269097
	9121843	9121843	Rear panel Connector, L	1	Pc	1	83024200
	9121844	9121844	Rear panel Connector, R	1	Pc	1	83024200
	9123011	9123011	Screw-On Front Connector	2	Pc	2	83024200
	9239287	9239287	Actro runner, L	1	Pc	1	83024200
	9239288	9239288	Actro runner, R	1	Pc	1	83024200
	9122003	9122003	Lengthwise Railing, L	1	Pc	1	73269098
	9122004	9122004	Lengthwise Railing, R	1	Pc	1	73269098
	9127011	9127011	Screw-On Railing Connector	2	Pc	2	39263000
BOM-Code	9243155	Total Set	MRP: 6,694				83021090
	ArciTech Silver 550 mm pot & pan with railing, Height 186 mm, 40 kg						
	9121209	9121209	Drawer side profile, L	1	Pc	1	94039010
	9121210	9121210	Drawer side profile, R	1	Pc	1	94039010
	9123005	9123005	Cover Cap	2	Pc	2	39269097
	9121843	9121843	Rear panel Connector, L	1	Pc	1	83024200
	9121844	9121844	Rear panel Connector, R	1	Pc	1	83024200
	9123011	9123011	Screw-On Front Connector	2	Pc	2	83024200
	9239293	9239293	Actro runner, L	1	Pc	1	83024200
	9239294	9239294	Actro runner, R	1	Pc	1	83024200
	9122013	9122013	Lengthwise Railing, L	1	Pc	1	73269098
	9122014	9122014	Lengthwise Railing, R	1	Pc	1	73269098
	9127011	9127011	Screw-On Railing Connector	2	Pc	2	39263000
BOM-Code	9243156	Total Set	MRP: 6,920				83021090

Drawer System ArciTech

► Drawer, height 94 & 186 mm



Product	Article No.	SAP	Item Description	Qty.	Unit	PU	HS Code
	ArciTech Silver 450 mm pot & pan with railing, Height 186 mm, 60 kg						
	9121205	9121205	Drawer side profile, L	1	Pc	1	94039010
	9121206	9121206	Drawer side profile, R	1	Pc	1	94039010
	9123005	9123005	Cover Cap	2	Pc	2	39269097
	9121843	9121843	Rear panel Connector, L	1	Pc	1	83024200
	9121844	9121844	Rear panel Connector, R	1	Pc	1	83024200
	9123011	9123011	Screw-On Front Connector	2	Pc	2	83024200
	9239285	9239285	Actro runner, L	1	Pc	1	83024200
	9239286	9239286	Actro runner, R	1	Pc	1	83024200
	9121993	9121993	Lengthwise Railing, L	1	Pc	1	73269098
	9121994	9121994	Lengthwise Railing, R	1	Pc	1	73269098
	9127011	9127011	Screw-On Railing Connector	2	Pc	2	39263000
BOM-Code	9243157	Total Set	MRP: 7,587				83021090
	ArciTech Silver 500 mm pot & pan with railing, Height 186 mm, 70 kg						
	9121207	9121207	Drawer side profile, L	1	Pc	1	94039010
	9121208	9121208	Drawer side profile, R	1	Pc	1	94039010
	9123005	9123005	Cover Cap	2	Pc	2	39269097
	9121843	9121843	Rear panel Connector, L	1	Pc	1	83024200
	9121844	9121844	Rear panel Connector, R	1	Pc	1	83024200
	9123011	9123011	Screw-On Front Connector	2	Pc	2	83024200
	9239289	9239289	Actro runner, L	1	Pc	1	83024200
	9239290	9239290	Actro runner, R	1	Pc	1	83024200
	9122003	9122003	Lengthwise Railing, L	1	Pc	1	73269098
	9122004	9122004	Lengthwise Railing, R	1	Pc	1	73269098
	9127011	9127011	Screw-On Railing Connector	2	Pc	2	39263000
BOM-Code	9243158	Total Set	MRP: 7,587				83021090
	ArciTech Silver 550 mm pot & pan with railing, Height 186 mm, 60 kg						
	9121209	9121209	Drawer side profile, L	1	Pc	1	94039010
	9121210	9121210	Drawer side profile, R	1	Pc	1	94039010
	9123005	9123005	Cover Cap	2	Pc	2	39269097
	9121843	9121843	Rear panel Connector, L	1	Pc	1	83024200
	9121844	9121844	Rear panel Connector, R	1	Pc	1	83024200
	9123011	9123011	Screw-On Front Connector	2	Pc	2	83024200
	9239295	9239295	Actro runner, L	1	Pc	1	83024200
	9239296	9239296	Actro runner, R	1	Pc	1	83024200
	9122013	9122013	Lengthwise Railing, L	1	Pc	1	73269098
	9122014	9122014	Lengthwise Railing, R	1	Pc	1	73269098
	9127011	9127011	Screw-On Railing Connector	2	Pc	2	39263000
BOM-Code	9243159	Total Set	MRP: 7,812				83021090
	ArciTech Silver 650 mm pot & pan with railing, Height 186 mm, 60 kg						
	9121211	9121211	Drawer side profile, L	1	Pc	1	94039010
	9121212	9121212	Drawer side profile, R	1	Pc	1	94039010
	9123005	9123005	Cover Cap	2	Pc	2	39269097
	9121843	9121843	Rear panel Connector, L	1	Pc	1	83024200
	9121844	9121844	Rear panel Connector, R	1	Pc	1	83024200
	9123011	9123011	Screw-On Front Connector	2	Pc	2	83024200
	9239301	9239301	Actro runner, L	1	Pc	1	83024200
	9239302	9239302	Actro runner, R	1	Pc	1	83024200
	9122033	9122033	Lengthwise Railing, L	1	Pc	1	73269098
	9122034	9122034	Lengthwise Railing, R	1	Pc	1	73269098
	9127011	9127011	Screw-On Railing Connector	2	Pc	2	39263000
BOM-Code	9243160	Total Set	MRP: 8,258				83021090

Drawer System ArciTech

► Drawer, height 94 & 186 mm



Product	Article No.	SAP	Item Description	Qty.	Unit	PU	HS Code
	ArciTech Silver 550 mm pot & pan with railing, Height 186 mm, 80 kg						
	9121209	9121209	Drawer side profile, L	1	Pc	1	94039010
	9121210	9121210	Drawer side profile, R	1	Pc	1	94039010
	9123005	9123005	Cover Cap	2	Pc	2	39269097
	9121843	9121843	Rear panel Connector, L	1	Pc	1	83024200
	9121844	9121844	Rear panel Connector, R	1	Pc	1	83024200
	9123011	9123011	Screw-On Front Connector	2	Pc	2	83024200
	9239297	9239297	Actro runner, L	1	Pc	1	83024200
	9239298	9239298	Actro runner, R	1	Pc	1	83024200
	9122013	9122013	Lengthwise Railing, L	1	Pc	1	73269098
	9122014	9122014	Lengthwise Railing, R	1	Pc	1	73269098
9127011	9127011	Screw-On Railing Connector	2	Pc	2	39263000	
BOM-Code	9243162	Total Set				MRP: 8,705	83021090
	ArciTech Silver 650 mm pot & pan with railing, Height 186 mm, 80 kg						
	9121211	9121211	Drawer side profile, L	1	Pc	1	94039010
	9121212	9121212	Drawer side profile, R	1	Pc	1	94039010
	9123005	9123005	Cover Cap	2	Pc	2	39269097
	9121843	9121843	Rear panel Connector, L	1	Pc	1	83024200
	9121844	9121844	Rear panel Connector, R	1	Pc	1	83024200
	9123011	9123011	Screw-On Front Connector	2	Pc	2	83024200
	9121113	9239301	Actro runner, L	1	Pc	1	83024200
	9121114	9239302	Actro runner, R	1	Pc	1	83024200
	9122033	9122033	Lengthwise Railing, L	1	Pc	1	73269098
	9122034	9122034	Lengthwise Railing, R	1	Pc	1	73269098
9127011	9127011	Screw-On Railing Connector	2	Pc	2	39263000	
BOM-Code	9243163	Total Set				MRP: 9,153	83021090
	ArciTech White 450 mm pot & pan with railing, Height 186 mm, 40 kg						
	9121247	9121247	Drawer side profile, L	1	Pc	1	94039010
	9121248	9121248	Drawer side profile, R	1	Pc	1	94039010
	9123006	9123006	Cover Cap	2	Pc	2	39269097
	9121845	9121845	Rear panel Connector, L	1	Pc	1	83024200
	9121846	9121846	Rear panel Connector, R	1	Pc	1	83024200
	9123011	9123011	Screw-On Front Connector	2	Pc	2	83024200
	9239283	9239283	Actro runner, L	1	Pc	1	83024200
	9239284	9239284	Actro runner, R	1	Pc	1	83024200
	9121997	9121997	Lengthwise Railing, L	1	Pc	1	73269098
	9121998	9121998	Lengthwise Railing, R	1	Pc	1	73269098
9127011	9127011	Screw-On Railing Connector	2	Pc	2	39263000	
BOM-Code	9243164	Total Set				MRP: 6,917	83021090



Drawer System ArciTech

► Drawer, height 94 & 186 mm



Product	Article No.	SAP	Item Description	Qty.	Unit	PU	HS Code
	ArciTech White 500 mm pot & pan with railing, Height 186 mm, 40 kg						
	9121249	9121249	Drawer side profile, L	1	Pc	1	94039010
	9121250	9121250	Drawer side profile, R	1	Pc	1	94039010
	9123006	9123006	Cover Cap	2	Pc	2	39269097
	9121845	9121845	Rear panel Connector, L	1	Pc	1	83024200
	9121846	9121846	Rear panel Connector, R	1	Pc	1	83024200
	9123011	9123011	Screw-On Front Connector	2	Pc	2	83024200
	9239287	9239287	Actro runner, L	1	Pc	1	83024200
	9239288	9239288	Actro runner, R	1	Pc	1	83024200
	9122007	9122007	Lengthwise Railing, L	1	Pc	1	73269098
	9122008	9122008	Lengthwise Railing, R	1	Pc	1	73269098
	9127011	9127011	Screw-On Railing Connector	2	Pc	2	39263000
BOM-Code	9243165	Total Set	MRP: 6,917				83021090
	ArciTech White 550 mm pot & pan with railing, Height 186 mm, 40 kg						
	9121251	9121251	Drawer side profile, L	1	Pc	1	94039010
	9121252	9121252	Drawer side profile, R	1	Pc	1	94039010
	9123006	9123006	Cover Cap	2	Pc	2	39269097
	9121845	9121845	Rear panel Connector, L	1	Pc	1	83024200
	9121846	9121846	Rear panel Connector, R	1	Pc	1	83024200
	9123011	9123011	Screw-On Front Connector	2	Pc	2	83024200
	9239293	9239293	Actro runner, L	1	Pc	1	83024200
	9239294	9239294	Actro runner, R	1	Pc	1	83024200
	9122017	9122017	Lengthwise Railing, L	1	Pc	1	94039010
	9122018	9122018	Lengthwise Railing, R	1	Pc	1	94039010
	9127011	9127011	Screw-On Railing Connector	2	Pc	2	39263000
BOM-Code	9243166	Total Set	MRP: 7,143				83021090
	ArciTech White 450 mm pot & pan with railing, Height 186 mm, 60 kg						
	9121247	9121247	Drawer side profile, L	1	Pc	1	94039010
	9121248	9121248	Drawer side profile, R	1	Pc	1	94039010
	9123006	9123006	Cover Cap	2	Pc	2	39269097
	9121845	9121845	Rear panel Connector, L	1	Pc	1	83024200
	9121846	9121846	Rear panel Connector, R	1	Pc	1	83024200
	9123011	9123011	Screw-On Front Connector	2	Pc	2	83024200
	9239285	9239285	Actro runner, L	1	Pc	1	83024200
	9239286	9239286	Actro runner, R	1	Pc	1	83024200
	9121997	9121997	Lengthwise Railing, L	1	Pc	1	73269098
	9121998	9121998	Lengthwise Railing, R	1	Pc	1	73269098
	9127011	9127011	Screw-On Railing Connector	2	Pc	2	39263000
BOM-Code	9243167	Total Set	MRP: 7,810				83021090
	ArciTech White 500 mm pot & pan with railing, Height 186 mm, 70 kg						
	9121249	9121249	Drawer side profile, L	1	Pc	1	94039010
	9121250	9121250	Drawer side profile, R	1	Pc	1	94039010
	9123006	9123006	Cover Cap	2	Pc	2	39269097
	9121845	9121845	Rear panel Connector, L	1	Pc	1	83024200
	9121846	9121846	Rear panel Connector, R	1	Pc	1	83024200
	9123011	9123011	Screw-On Front Connector	2	Pc	2	83024200
	9239289	9239289	Actro runner, L	1	Pc	1	83024200
	9239290	9239290	Actro runner, R	1	Pc	1	83024200
	9122007	9122007	Lengthwise Railing, L	1	Pc	1	73269098
	9122008	9122008	Lengthwise Railing, R	1	Pc	1	73269098
	9127011	9127011	Screw-On Railing Connector	2	Pc	2	39263000
BOM-Code	9243168	Total Set	MRP: 7,810				83021090

Drawer System ArciTech

► Drawer, height 94 & 186 mm



Product	Article No.	SAP	Item Description	Qty.	Unit	PU	HS Code
	ArciTech White 550 mm pot & pan with railing, Height 186 mm, 60 kg						
	9121251	9121251	Drawer side profile, L	1	Pc	1	94039010
	9121252	9121252	Drawer side profile, R	1	Pc	1	94039010
	9123006	9123006	Cover Cap	2	Pc	2	39269097
	9121845	9121845	Rear panel Connector, L	1	Pc	1	83024200
	9121846	9121846	Rear panel Connector, R	1	Pc	1	83024200
	9123011	9123011	Screw-On Front Connector	2	Pc	2	83024200
	9239295	9239295	Actro runner, L	1	Pc	1	83024200
	9239296	9239296	Actro runner, R	1	Pc	1	83024200
	9122017	9122017	Lengthwise Railing, L	1	Pc	1	94039010
	9122018	9122018	Lengthwise Railing, R	1	Pc	1	94039010
	9127011	9127011	Screw-On Railing Connector	2	Pc	2	39263000
BOM-Code	9243169	Total Set	MRP: 8,035				83021090

	ArciTech White 550 mm pot & pan with railing, Height 186 mm, 80 kg						
	9121251	9121251	Drawer side profile, L	1	Pc	1	94039010
	9121252	9121252	Drawer side profile, R	1	Pc	1	94039010
	9123006	9123006	Cover Cap	2	Pc	2	39269097
	9121845	9121845	Rear panel Connector, L	1	Pc	1	83024200
	9121846	9121846	Rear panel Connector, R	1	Pc	1	83024200
	9123011	9123011	Screw-On Front Connector	2	Pc	2	83024200
	9239297	9239297	Actro runner, L	1	Pc	1	83024200
	9239298	9239298	Actro runner, R	1	Pc	1	83024200
	9122017	9122017	Lengthwise Railing, L	1	Pc	1	94039010
	9122018	9122018	Lengthwise Railing, R	1	Pc	1	94039010
	9127011	9127011	Screw-On Railing Connector	2	Pc	2	39263000
BOM-Code	9243172	Total Set	MRP: 8,928				83021090

	ArciTech Anthracite 450 mm pot & pan with railing, Height 186 mm, 40 kg						
	9121289	9121289	Drawer side profile, L	1	Pc	1	94039010
	9121290	9121290	Drawer side profile, R	1	Pc	1	94039010
	9123005	9123005	Cover Cap	2	Pc	2	39269097
	9121847	9121847	Rear panel Connector, L	1	Pc	1	83024200
	9121848	9121848	Rear panel Connector, R	1	Pc	1	83024200
	9123011	9123011	Screw-On Front Connector	2	Pc	2	83024200
	9239283	9239283	Actro runner, L	1	Pc	1	83024200
	9239284	9239284	Actro runner, R	1	Pc	1	83024200
	9121995	9121995	Lengthwise Railing, L	1	Pc	1	73269098
	9121996	9121996	Lengthwise Railing, R	1	Pc	1	73269098
	9127011	9127011	Screw-On Railing Connector	2	Pc	2	39263000
BOM-Code	9243174	Total Set	MRP: 6,917				83021090



Drawer System ArciTech

► Drawer, height 94 & 186 mm



Product	Article No.	SAP	Item Description	Qty.	Unit	PU	HS Code
	ArciTech Anthracite 500 mm pot & pan with railing, Height 186 mm, 40 kg						
	9121291	9121291	Drawer side profile, L	1	Pc	1	94039010
	9121292	9121292	Drawer side profile, R	1	Pc	1	94039010
	9123005	9123005	Cover Cap	2	Pc	2	39269097
	9121847	9121847	Rear panel Connector, L	1	Pc	1	83024200
	9121848	9121848	Rear panel Connector, R	1	Pc	1	83024200
	9123011	9123011	Screw-On Front Connector	2	Pc	2	83024200
	9239287	9239287	Actro runner, L	1	Pc	1	83024200
	9239288	9239288	Actro runner, R	1	Pc	1	83024200
	9122005	9122005	Lengthwise Railing, L	1	Pc	1	73269098
	9122006	9122006	Lengthwise Railing, R	1	Pc	1	73269098
	9127011	9127011	Screw-On Railing Connector	2	Pc	2	39263000
BOM-Code	9243175	Total Set	MRP: 6,917				83021090
	ArciTech Anthracite 550 mm pot & pan with railing, Height 186 mm, 40 kg						
	9121293	9121293	Drawer side profile, L	1	Pc	1	94039010
	9121294	9121294	Drawer side profile, R	1	Pc	1	94039010
	9123005	9123005	Cover Cap	2	Pc	2	39269097
	9121847	9121847	Rear panel Connector, L	1	Pc	1	83024200
	9121848	9121848	Rear panel Connector, R	1	Pc	1	83024200
	9123011	9123011	Screw-On Front Connector	2	Pc	2	83024200
	9239293	9239293	Actro runner, L	1	Pc	1	83024200
	9239294	9239294	Actro runner, R	1	Pc	1	83024200
	9122015	9122015	Lengthwise Railing, L	1	Pc	1	73269098
	9122016	9122016	Lengthwise Railing, R	1	Pc	1	73269098
	9127011	9127011	Screw-On Railing Connector	2	Pc	2	39263000
BOM-Code	9243176	Total Set	MRP: 7,141				83021090
	ArciTech Anthracite 450 mm pot & pan with railing, Height 186 mm, 60 kg						
	9121289	9121289	Drawer side profile, L	1	Pc	1	94039010
	9121290	9121290	Drawer side profile, R	1	Pc	1	94039010
	9123005	9123005	Cover Cap	2	Pc	2	39269097
	9121847	9121847	Rear panel Connector, L	1	Pc	1	83024200
	9121848	9121848	Rear panel Connector, R	1	Pc	1	83024200
	9123011	9123011	Screw-On Front Connector	2	Pc	2	83024200
	9239285	9239285	Actro runner, L	1	Pc	1	83024200
	9239286	9239286	Actro runner, R	1	Pc	1	83024200
	9121995	9121995	Lengthwise Railing, L	1	Pc	1	73269098
	9121996	9121996	Lengthwise Railing, R	1	Pc	1	73269098
	9127011	9127011	Screw-On Railing Connector	2	Pc	2	39263000
BOM-Code	9243177	Total Set	MRP: 7,812				83021090
	ArciTech Anhracite 500 mm pot & pan with railing, Height 186 mm, 70 kg						
	9121291	9121291	Drawer side profile, L	1	Pc	1	94039010
	9121292	9121292	Drawer side profile, R	1	Pc	1	94039010
	9123005	9123005	Cover Cap	2	Pc	2	39269097
	9121847	9121847	Rear panel Connector, L	1	Pc	1	83024200
	9121848	9121848	Rear panel Connector, R	1	Pc	1	83024200
	9123011	9123011	Screw-On Front Connector	2	Pc	2	83024200
	9239289	9239289	Actro runner, L	1	Pc	1	83024200
	9239290	9239290	Actro runner, R	1	Pc	1	83024200
	9122005	9122005	Lengthwise Railing, L	1	Pc	1	73269098
	9122006	9122006	Lengthwise Railing, R	1	Pc	1	73269098
	9127011	9127011	Screw-On Railing Connector	2	Pc	2	39263000
BOM-Code	9243178	Total Set	MRP: 7,812				83021090

Drawer System ArciTech

► Drawer, height 94 & 186 mm



Product	Article No.	SAP	Item Description	Qty.	Unit	PU	HS Code
ArciTech Anthracite 550 mm pot & pan with railing, Height 186 mm, 60 kg							
	9121293	9121293	Drawer side profile, L	1	Pc	1	94039010
	9121294	9121294	Drawer side profile, R	1	Pc	1	94039010
	9123005	9123005	Cover Cap	2	Pc	2	39269097
	9121847	9121847	Rear panel Connector, L	1	Pc	1	83024200
	9121848	9121848	Rear panel Connector, R	1	Pc	1	83024200
	9123011	9123011	Screw-On Front Connector	2	Pc	2	83024200
	9239295	9239295	Actro runner, L	1	Pc	1	83024200
	9239296	9239296	Actro runner, R	1	Pc	1	83024200
	9122015	9122015	Lengthwise Railing, L	1	Pc	1	73269098
	9122016	9122016	Lengthwise Railing, R	1	Pc	1	73269098
9127011	9127011	Screw-On Railing Connector	2	Pc	2	39263000	
BOM-Code	9243179	Total Set	MRP: 8,032				83021090

ArciTech Anthracite 550 mm pot & pan with railing, Height 186 mm, 80 kg							
	9121293	9121293	Drawer side profile, L	1	Pc	1	94039010
	9121294	9121294	Drawer side profile, R	1	Pc	1	94039010
	9123005	9123005	Cover Cap	2	Pc	2	39269097
	9121847	9121847	Rear panel Connector, L	1	Pc	1	83024200
	9121848	9121848	Rear panel Connector, R	1	Pc	1	83024200
	9123011	9123011	Screw-On Front Connector	2	Pc	2	83024200
	9239297	9239297	Actro runner, L	1	Pc	1	83024200
	9239298	9239298	Actro runner, R	1	Pc	1	83024200
	9122015	9122015	Lengthwise Railing, L	1	Pc	1	73269098
	9122016	9122016	Lengthwise Railing, R	1	Pc	1	73269098
9127011	9127011	Screw-On Railing Connector	2	Pc	2	39263000	
BOM-Code	9243182	Total Set	MRP: 8,926				83021090



Drawer System ArciTech

► Accessories



Product	Article No.	SAP	Item Description	Qty.	Unit	PU	MRP	HS Code
	Accessories for ArciTech Silver 500 / 550 mm							
	9122920	9122920	ArciTech Topside- 500 mm	1	Set	1	2,658	73269098
	9122988	9122988	ArciTech DesignSide- 500 mm	1	Set	1	1,868	70200080
	9122989	9122989	ArciTech DesignSide- 550 mm	1	Set	1	1,902	70200080
	9122973	9122973	ArciTech DesignSide Adapter	1	Set	1	1,358	83024200
	ArciTech Silver, front panel, Internal Drawer height 94 / 186 mm							
	9122799	9122799	94 / 600 mm	1	Pc	15	2,901	94039010
	9122853	9122853	186 / 600 mm	1	Pc	15	3,907	94039010
	9122801	9122801	94 / 900 mm	1	Pc	15	4,060	94039010
	9122855	9122855	186 / 900 mm	1	Pc	15	5,020	94039010
	9192204	9192204	Aluminium front panel, L 2000 mm	1	Pc	1	3,820	76042990
	9182706	9182706	Railing for Aluminium front panel	1	Pc	1	2,431	73066192
	9123083	9123083	Front connector H 94	1	Pc	15	1,358	83024200
	9123089	9123089	Front connector H 186	1	Pc	15	2,241	83024200
9192208	9192208	Glass Profile C for front panel, L 2000	1	Pc	1	2,887	76042990	
	Accessories for ArciTech White 500 / 550 mm							
	9122988	9122988	ArciTech DesignSide- 500 mm	1	Set	1	1,868	70200080
	9122989	9122989	ArciTech DesignSide- 550 mm	1	Set	1	1,902	70200080
	9122975	9122975	ArciTech DesignSide Adapter	1	Set	15	1,358	83024200
	ArciTech White 500 mm, front panel, Internal drawer height 94 / 186 mm							
	9122862	9122862	ArciTech front panel 186 / 600 mm	1	Set	15	3,728	94039010
	9123090	9123090	Front connector H 186	1	Set	15	2,241	83024200
	Accessories for ArciTech Anthracite 500 / 550 mm							
	9122921	9122921	ArciTech Topside- 500 mm	1	Set	1	2,658	73269098
	9122988	9122988	ArciTech DesignSide- 500 mm	1	Set	1	1,868	70200080
	9122989	9122989	ArciTech DesignSide- 550 mm	1	Set	1	1,902	70200080
	9122974	9122974	ArciTech DesignSide Adapter	1	Set	1	1,358	83024200
	ArciTech Anthracite, front panel, Internal drawer height 94 / 186 mm							
	9140089	9140089	94 / 600 mm	1	Set	15	2,901	94039010
	9140107	9140107	186 / 600 mm	1	Set	15	3,907	94039010
	9192205	9192205	Aluminium front panel, L 2000 mm	1	Pc	1	5,405	76042990
	9140121	9140121	Front connector H 94	1	Pc	15	1,766	83024200

Product	Article No.	SAP	Item Description	Qty.	Unit	PU	MRP	HS Code
	OrgaTray 570 Silver (Adjustable Partition Cutlery)							
	9134992	9134992	For NL 500 mm depth, cabinet width 600 mm	1	Set	1	2,126	39249000
	9134994	9134994	For NL 500 mm depth, cabinet width 900 mm	1	Set	1	3,791	39249000
	OrgaTray 440 Trimmable (Fixed Partition Cutlery)							
	9194924	9194924	Tray width 501-600 mm, depth 380-440 mm	1	Pc	1	679	39249000
	9194934	9194934	Tray width 351-400 mm, depth 441-520 mm	1	Pc	1	511	39249000
	9194935	9194935	Tray width 401-450 mm, depth 441-520 mm	1	Pc	1	540	39249000
	9194936	9194936	Tray width 451-500 mm, depth 441-520 mm	1	Pc	1	591	39249000
	9194937	9194937	Tray width 501-600 mm, depth 441-520 mm	1	Pc	1	704	39249000
	9194938	9194938	Tray width 601-700 mm, Depth 441- 520 mm	1	Pc	1	2,750	39249000
	9194939	9194939	Tray width 701-800 mm, depth 441-520 mm	1	Pc	1	1,349	39249000
	9194940	9194940	Tray width 801-900 mm, depth 441-520 mm	1	Pc	1	1,417	39249000
	OrgaStore 400 customised width							
	9182706	9182706	Crosswise railing 2000 mm silver	1	Pc	1	2,431	73066192
	9182222	9182222	Adapter anthracite	1	Pc	1	141	39269097
	9182225	9182225	Lengthwise divider anthracite	1	Pc	1	313	39269097
	9182714	9182714	Crosswise railing 2000 mm white	1	Pc	1	2,431	73066192
	9182712	9182712	Crosswise railing 2000 mm anthracite	1	Pc	1	2,431	73066192
	OrgaStore 230 Oak							
	9199647	9199647	OrgaStore 230 B600 T500 Oak	1	Pc	1	6,112	44199090
	9190578	9190578	OrgaStore 230 Separator Oak	1	Pc	1	2,981	44199090
	9190577	9190577	OrgaStore 230 Separating Angle Oak	1	Pc	1	4,291	44199090
	OrgaTray 610 (Powder Coated Steel Cutlery)							
	9194883	9194883	OrgaTray 610 frame Anthracite for 450 mm	1	Pc	1	5,295	73239900
	9194882	9194882	OrgaTray 610 Frame White for 450 mm	1	Pc	1	5,043	73269098

Drawer System ArciTech

► Accessories





Product	Article No.	SAP	Item Description	Qty.	Unit	PU	MRP	HS Code
Anti-slip mat for ArciTech								
	Anti-slip mat - Classic (5 m roll)							
	9209580	9209580	500 mm NL PVC, Anthracite	1	Pc	1	6,772	39269097
	Anti-slip mat - Hard Chequered (5 m roll)							
	9290041	9290041	Anti slip mat W5000 D500 CA930 Silver	1	Pc	1	1,584	39181090
	9290042	9290042	Anti slip mat W5000 D550 CA930 Silver	1	Pc	1	1,740	39181090
	9290053	9290053	Anti slip mat W5000 D500 CA930 Anthracite	1	Pc	1	1,584	39181090
	9290054	9290054	Anti slip mat W5000 D550 CA930 Anthracite	1	Pc	1	1,740	39181090
	Anti-slip mat - Soft Fine Chequered (5 m roll)							
	9290045	9290045	Anti slip mat W5000 D500 CA009 Silver	1	Pc	1	3,547	39181090
	9290046	9290046	Anti slip mat W5000 D550 CA009 Silver	1	Pc	1	3,909	39181090
	9290057	9290057	Anti slip mat W5000 D500 CA009 Anthracite	1	Pc	1	3,547	39181090
	9290058	9290058	Anti slip mat W5000 D550 CA009 Anthracite	1	Pc	1	3,909	39181090
	Anti-slip mat- Big Dots (5 m roll)							
	9290049	9290049	Anti slip mat W5000 D500 CA006 Silver	1	Pc	1	3,391	39181090
	9290050	9290050	Anti slip mat W5000 D550 CA006 Silver	1	Pc	1	3,748	39181090
	9290061	9290061	Anti slip mat W5000 D500 CA006 Anthracite	1	Pc	1	3,391	39181090
	9290062	9290062	Anti slip mat W5000 D550 CA006 Anthracite	1	Pc	1	3,748	39181090
	ArciTech Support Materials							
	9123080	9123080	Front Stabiliser (Recommended for >= 600 mm front fascia width)	1	Pc	1	274	39263000
	9122998	9122998	DesignSide Connectors	1	Pc	1	1,189	83024200
	Connector for front							
	9140123	9140123	Connector for Front - Anthracite	1	Set	1	2,241	83024200
	9123091	9123091	Connector for Front - Champagne	1	Set	1	2,462	83024200
	ArciTech Back Panel							
	9121420	9121420	Back Panel - Anthracite - 94 mm 900 W	1	Pc	1	812	94039010
	9121576	9121576	Back Panel -Anthracite - 186 mm 900 W	1	Pc	1	1,329	94039010
	ArciTech Back Panel Connector							
	9121851	9121851	Back panel connector Silver Left-218 mm	1	Pc	1	396	83024200
	9121852	9121852	Back panel connector Silver Right--218 mm	1	Pc	1	396	83024200
	9121867	9121867	Back panel connector Silver Left--282 mm	1	Pc	1	585	83024200
	9121868	9121868	Back panel connector Silver Right--282 mm	1	Pc	1	585	83024200
	9121853	9121853	Back panel connector White Left-218 mm	1	Pc	1	396	83024200
	9121854	9121854	Back panel connector White Right -218 mm	1	Pc	1	396	83024200
	9121855	9121855	Back panel connector Anthracite Left-218 mm	1	Pc	1	396	83024200
	9121856	9121856	Back panel connector Anthracite Right -218 mm	1	Pc	1	396	83024200

Drawer System ArciTech

► Accessories



Product	Article No.	SAP	Item Description	Qty.	Unit	PU	MRP	HS Code
ArciTech Drawer Side Profile								
	Finish : Silver							
	9121205	9121205	ArciTech - 450 mm-Drawer side profile, L - Silver	1	Pc	1	862	94039010
	9121206	9121206	ArciTech - 450 mm-Drawer side profile, R - Silver	1	Pc	1	862	94039010
	9121207	9121207	ArciTech - 500 mm-Drawer side profile, L - Silver	1	Pc	1	862	94039010
	9121208	9121208	ArciTech - 500 mm-Drawer side profile, R - Silver	1	Pc	1	862	94039010
	9121209	9121209	ArciTech - 550 mm-Drawer side profile, L - Silver	1	Pc	1	969	94039010
	9121210	9121210	ArciTech - 550 mm-Drawer side profile, R - Silver	1	Pc	1	969	94039010
	9121211	9121211	ArciTech - 650 mm-Drawer side profile, L - Silver	1	Pc	1	1,005	94039010
	9121212	9121212	ArciTech - 650 mm-Drawer side profile, R - Silver	1	Pc	1	1,005	94039010
	Finish : White							
	9121247	9121247	ArciTech - 450 mm-Drawer side profile, L-White	1	Pc	1	917	94039010
	9121248	9121248	ArciTech - 450 mm-Drawer side profile, R-White	1	Pc	1	917	94039010
	9121249	9121249	ArciTech - 500 mm-Drawer side profile, L-White	1	Pc	1	917	94039010
	9121250	9121250	ArciTech - 500 mm-Drawer side profile, R-White	1	Pc	1	917	94039010
	9121251	9121251	ArciTech - 550 mm-Drawer side profile, L-White	1	Pc	1	1,025	94039010
	9121252	9121252	ArciTech - 550 mm-Drawer side profile, R-White	1	Pc	1	1,025	94039010
	Finish : Anthracite							
	9121289	9121289	ArciTech-450 mm-Drawer side profile, L-Anthracite	1	Pc	1	923	94039010
	9121290	9121290	ArciTech-450 mm-Drawer side profile, R-Anthracite	1	Pc	1	923	94039010
	9121291	9121291	ArciTech-500 mm-Drawer side profile, L-Anthracite	1	Pc	1	923	94039010
	9121292	9121292	ArciTech-500 mm-Drawer side profile, R-Anthracite	1	Pc	1	923	94039010
	9121293	9121293	ArciTech-550 mm-Drawer side profile, L-Anthracite	1	Pc	1	1,029	94039010
	9121294	9121294	ArciTech-550 mm-Drawer side profile, R-Anthracite	1	Pc	1	1,029	94039010
Lengthwise railing								
	Finish : Silver							
	9121993	9121993	Lengthwise Railing, L - 450 mm - Silver	1	Pc	1	375	73269098
	9121994	9121994	Lengthwise Railing, R - 450 mm - Silver	1	Pc	1	375	73269098
	9122003	9122003	Lengthwise Railing, L - 500 mm - Silver	1	Pc	1	375	73269098
	9122004	9122004	Lengthwise Railing, R - 500 mm - Silver	1	Pc	1	375	73269098
	9122013	9122013	Lengthwise Railing, L - 550 mm - Silver	1	Pc	1	375	73269098
	9122014	9122014	Lengthwise Railing, R - 550 mm - Silver	1	Pc	1	375	73269098
	9122033	9122033	Lengthwise Railing, L - 650 mm - Silver	1	Pc	1	375	73269098
	9122034	9122034	Lengthwise Railing, R - 650 mm - Silver	1	Pc	1	375	73269098
9127011	9127011	Screw-on Railing connector	1	Pc	1	45	39263000	
	Finish : White							
	9121997	9121997	Lengthwise Railing, L - 450 mm - White	1	Pc	1	454	73269098
	9121998	9121998	Lengthwise Railing, R - 450 mm - White	1	Pc	1	454	73269098
	9122007	9122007	Lengthwise Railing, L - 500 mm - White	1	Pc	1	454	73269098
	9122008	9122008	Lengthwise Railing, R - 500 mm - White	1	Pc	1	454	73269098
	9122017	9122017	Lengthwise Railing, L - 550 mm - White	1	Pc	1	454	94039010
	9122018	9122018	Lengthwise Railing, R - 550 mm - White	1	Pc	1	454	94039010
9127011	9127011	Screw-on Railing connector	1	Pc	1	45	39263000	

Drawer System ArciTech

► Accessories



Product	Article No.	SAP	Item Description	Qty.	Unit	PU	MRP	HS Code	
	Finish : Anthracite								
	9121995	9121995	Lengthwise Railing, L - 450 mm - Anthracite	1	Pc	1	454	73269098	
	9121996	9121996	Lengthwise Railing, R - 450 mm - Anthracite	1	Pc	1	454	73269098	
	9122005	9122005	Lengthwise Railing, L - 500 mm - Anthracite	1	Pc	1	454	73269098	
	9122006	9122006	Lengthwise Railing, R - 500 mm - Anthracite	1	Pc	1	454	73269098	
	9122015	9122015	Lengthwise Railing, L - 550 mm - Anthracite	1	Pc	1	454	73269098	
	9122016	9122016	Lengthwise Railing, R - 550 mm - Anthracite	1	Pc	1	454	73269098	
9127011	9127011	Screw-on Railing connector	1	Pc	1	45	39263000		

Rear Panel Connector

	Finish : Silver								
	9121827	9121827	Rear panel Connector, L - 94 mm - Silver	1	Pc	1	241	83024200	
	9121828	9121828	Rear panel Connector, R - 94 mm - Silver	1	Pc	1	241	83024200	
	9121843	9121843	Rear panel Connector, L - 186 mm - Silver	1	Pc	1	380	83024200	
9121844	9121844	Rear panel Connector, R- 186 mm - Silver	1	Pc	1	380	83024200		

	Finish : White								
	9121829	9121829	Rear panel Connector, L - 94 mm - White	1	Pc	1	292	83024200	
	9121830	9121830	Rear panel Connector, R - 94 mm - White	1	Pc	1	292	83024200	
	9121845	9121845	Rear panel Connector, L - 186 mm - White	1	Pc	1	351	83024200	
9121846	9121846	Rear panel Connector, R - 186 mm - White	1	Pc	1	351	83024200		



	Finish : Anthracite								
	9121831	9121831	Rear panel Connector, L - 94 mm - Anthracite	1	Pc	1	292	83024200	
	9121832	9121832	Rear panel Connector, R - 94 mm - Anthracite	1	Pc	1	292	83024200	
	9121847	9121847	Rear panel Connector, L - 186 mm - Anthracite	1	Pc	1	351	83024200	
9121848	9121848	Rear panel Connector, R - 186 mm - Anthracite	1	Pc	1	351	83024200		



Drawer System ArciTech

► Accessories



Product	Article No.	SAP	Item Description	Qty.	Unit	PU	MRP	HS Code
ArciTech Cover Cap								
	9123005	9123005	Cover Cap - Sliver	2	Pc	2	65	39269097
	9123006	9123006	Cover Cap - White	2	Pc	2	77	39269097
	9123005	9123005	Cover Cap - Anthracite	2	Pc	2	65	39269097
Push to open Silent opening system for ArciTech								
	9241050	9241050	PTO Silent System Set up to 10 Kg - 40 Kg	1	Set	1	3,884	39263090
	9241051	9241051	PTO Silent System Set up to 20 Kg - 80 Kg	1	Set	1	3,884	39263000
Synchronisation Mechanism for 600 mm and above drawer carcass widths								
	9236718	9236718	Synchronisation Bar - 2000 mm	1	Pc	100	650	83024200
	9221295	9221295	Mid Connector	1	Pc	20	100	39269097
Actro Runners								
	Actro Runners 40 kg							
	9239283	9239283	Actro runner, 450 mm L - 40 Kg	1	Pc	1	1,514	83024200
	9239284	9239284	Actro runner, 450 mm R - 40 Kg	1	Pc	1	1,514	83024200
	9239287	9239287	Actro runner, 500 mm L - 40 Kg	1	Pc	1	1,514	83024200
	9239288	9239288	Actro runner, 500 mm R - 40 Kg	1	Pc	1	1,514	83024200
	9239293	9239293	Actro runner, 550 mm L - 40 Kg	1	Pc	1	1,520	83024200
	9239294	9239294	Actro runner, 550 mm R - 40 Kg	1	Pc	1	1,520	83024200
	Actro Runners 70/60 kg							
	9239285	9239285	Actro runner, 450 mm L - 60 Kg	1	Pc	1	1,960	83024200
	9239286	9239286	Actro runner, 450 mm R - 60 Kg	1	Pc	1	1,960	83024200
	9239289	9239289	Actro runner, 500 mm L - 70 Kg	1	Pc	1	1,960	83024200
	9239290	9239290	Actro runner, 500 mm R - 70 Kg	1	Pc	1	1,960	83024200
	9239295	9239295	Actro runner, 550 mm L - 60 Kg	1	Pc	1	1,965	83024200
	9239296	9239296	Actro runner, 550 mm R - 60 Kg	1	Pc	1	1,965	83024200
	9239301	9239301	Actro runner, 650 mm L - 60 Kg	1	Pc	1	2,150	83024200
9239302	9239302	Actro runner, 650 mm R - 60 Kg	1	Pc	1	2,150	83024200	
	Actro Runners 80 kg							
	9239297	9239297	Actro runner, 550 mm L - 80 Kg	1	Pc	1	2,411	83024200
	9239298	9239298	Actro runner, 550 mm R - 80 Kg	1	Pc	1	2,411	83024200
	9121113	9121113	Actro runner, 650 mm L - 80 Kg	1	Pc	1	2,598	83024200
9121114	9121114	Actro runner, 650 mm R - 80 Kg	1	Pc	1	2,598	83024200	





Pull Out Shelf











Cargo IQ 200

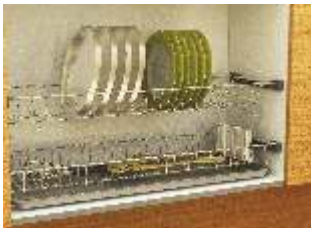







Moving Corner



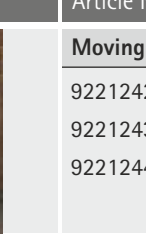
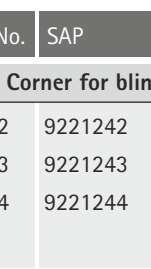
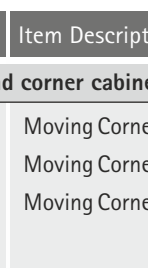
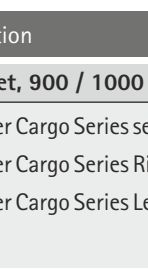
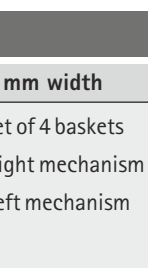

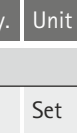

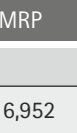
Product	Article No.	SAP	Item Description	Qty.	Unit	PU	MRP	HS Code
CargoTech Plain Wire Basket (For 500 mm depth)								
<p>Height- 100 mm</p> <p>Height- 150 mm</p> <p>Height- 200 mm</p>	9156381	9156381	(386 x 500 x 100) Cab.450 mm (15" x 20" x 4")	1	Pc	6	2,830	73239390
	9156383	9156383	(386 x 500 x 150) Cab.450 mm (15" x 20" x 6")	1	Pc	4	3,334	73239390
	9156384	9156384	(386 x 500 x 200) Cab.450 mm (15" x 20" x 8")	1	Pc	3	3,842	73239390
	9156385	9156385	(436 x 500 x 100) Cab.500 mm (17" x 20" x 4")	1	Pc	6	3,072	73239390
	9156386	9156386	(436 x 500 x 150) Cab.500 mm (17" x 20" x 6")	1	Pc	4	3,530	73239390
	9156387	9156387	(436 x 500 x 200) Cab.500 mm (17" x 20" x 8")	1	Pc	3	4,065	73239390
	9159547	9159547	(486 x 500 x 100) Cab.550 mm (19" x 20" x 4")	1	Pc	6	3,169	73239390
	9159548	9159548	(486 x 500 x 150) Cab.550 mm (19" x 20" x 6")	1	Pc	4	3,728	73239390
	9159549	9159549	(486 x 500 x 200) Cab.550 mm (19" x 20" x 8")	1	Pc	3	4,287	73239390
	9156388	9156388	(536 x 500 x 100) Cab.600 mm (21" x 20" x 4")	1	Pc	6	3,338	73239390
	9156389	9156389	(536 x 500 x 150) Cab.600 mm (21" x 20" x 6")	1	Pc	4	3,921	73239390
	9156390	9156390	(536 x 500 x 200) Cab.600 mm (21" x 20" x 8")	1	Pc	3	4,504	73239390
9156391	9156391	(836 x 500 x 100) Cab.900 mm (33" x 20" x 4")	1	Pc	6	4,519	73239390	
9156392	9156392	(836 x 500 x 150) Cab.900 mm (33" x 20" x 6")	1	Pc	4	5,279	73239390	
9156393	9156393	(836 x 500 x 200) Cab.900 mm (33" x 20" x 8")	1	Pc	3	6,040	73239390	
CargoTech Inlets (for 500 mm depth)								
<p>Thali Inlet</p> <p>Plate Inlet</p> <p>Cup & Saucer Inlet</p> <p>Saucer Inlet</p> <p>Cup Inlet</p> <p>Bottle Separator Inlet</p> <p>Basket Divider Inlet</p>	9156342	9156342	Thali Inlet, height-200 mm	1	Pc	5	1,153	73239390
	9156343	9156343	Plate Inlet, height-200 mm	1	Pc	5	1,274	73239390
	9156344	9156344	Cup & Saucer Inlet, height 150 mm	1	Pc	5	1,213	73239390
	9156345	9156345	Saucer Inlet, height 100 mm	1	Pc	10	970	73239390
	9156346	9156346	Cup Inlet, height 100 mm	1	Pc	10	848	73239390
	9156347	9156347	Bottle Separator Inlet, height 200 mm	1	Pc	3	479	73239390
	9156408	9156408	Basket Divider Inlet, height 100 mm	1	Pc	5	666	73239390
	9156409	9156409	Basket Divider Inlet, height 150 mm	1	Pc	5	727	73239390
	9156410	9156410	Basket Divider Inlet, height 200 mm	1	Pc	5	848	73239390
	9190416	9190416	CT Cutlery Inlet for 500 mm depth- 100 mm	1	Pc	10	848	73239390
9190417	9190417	CT Cutlery Inlet for 500 mm depth- 144 mm	1	Pc	10	910	73239390	
Cargo Cutlery Basket								
<p>Saucer Inlet</p> <p>Cup Inlet</p> <p>Bottle Separator Inlet</p> <p>Basket Divider Inlet</p> <p>Cargo Cutlery Basket</p>	9275311	9275311	Cargo Cutlery Basket W 436 (436 x 500x 94)	1	Pc	1	2,742	73239390
	9275312	9275312	Cargo Cutlery Basket W 486 (486 x 500x 94)	1	Pc	1	2,953	73239390
	9270287	9270287	Cargo Cutlery Basket W 536 (536 x 500x 94)	1	Pc	1	3,164	73239390
<p>Cargo Cutlery Basket</p>								

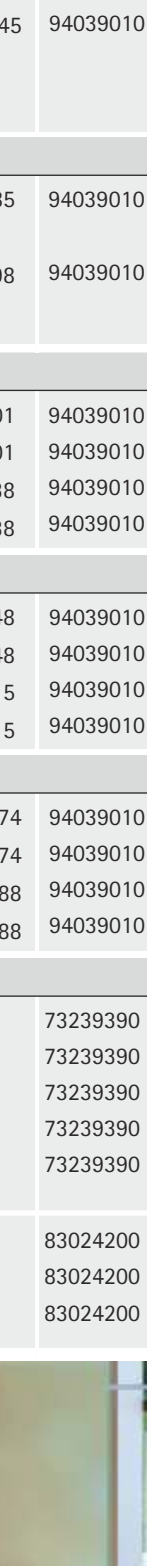
Product	Article No.	SAP	Item Description	Qty.	Unit	PU	MRP	HS Code
Under Sink Basket Cargo Series								
	9190451	9190451	UnderSink Basket- 900 mm	1	Pc	1	6,665	73239390
Detergent Holder Cargo Series								
	9197058	9197058	Detergent Holder Cargo Series (Recommended shutter width 450 mm)	1	Set	1	1,838	73239390
Dish Drainer Set Cargo Series								
	9206160	9206160	Dish Drainer Set- 600 mm	1	Set	1	4,131	73239390
	9206161	9206161	Dish Drainer Set- 900 mm	1	Set	1	5,751	73239390
Portable Dish Drainer								
	9267212	9267212	Cargo Portable Dish Drainer	1	Pc	1	2,530	73239390
	9190453	9190453	Collecting cargo PVC Tray 600 mm	1	Pc	1	295	39263090
	9267309	9267309	Acrylic sheet Portable Drainer	1	Pc	1	420	39263090
Dish Drainer Set								
	9219096	9219096	Cargo Dish Rack with Draining Board 600 mm	1	Set	1	4,422	94039010
	9219097	9219097	Cargo Dish Rack with Draining Board 900 mm	1	Set	1	6,194	94039010
Fruit-Vegetable Drainer								
	9291303	9291303	Fruit-Vegetable Drainer	1	Set	1	1,878	73239390
Pull Out Shelf - Wall unit								
	9209343	9209343	W 536 mm x D 250 mm x H 41 Cab.600 mm	1	Set	2	2,222	73239390
	9210437	9210437	W 686 mm x D 250 mm x H 41 mm Cab.750 mm	1	Set	2	2,889	73239390
	9209346	9209346	W 836 mm x D 250 mm x H 41 Cab.900 mm	1	Set	2	3,458	73239390
CargoTech Accessories								
	1180142	1180142	Clamps for KA	1	Set	1	48	83024200
	9160975	9160975	Clamps for Quadro	1	Set	1	48	83024200
	9200681	9200681	Cargo IQ 200 Series Clamp for Quadro Left Set	1	Set	1	140	94039000
	9200682	9200682	Cargo IQ 200 Series Clamp for Quadro Right Set	1	Set	1	140	94039000
	9162315	9162315	End Connector for inlets	1	Set	1	29	83024200

Product	Article No.	SAP	Item Description	Qty.	Unit	PU	MRP	HS Code	
	CargoPlus (CP)								
	9216602	9216602	CP Plain W 312mm, for IT 470 mm NL, Cab.450mm	1	Pc	4	1,865	73239390	
	9216603	9216603	CP Plain W 462mm, For IT 470 mm NL, Cab.600mm	1	Pc	4	2,237	73239390	
	9216604	9216604	CP Plain W 762mm, For IT 470 mm NL, Cab.900mm	1	Pc	4	3,298	73239390	
	9216605	9216605	CP Plain W 312mm, for IT 520 mm NL, Cab.450mm	1	Pc	4	1,967	73239390	
	9216606	9216606	CP Plain W 462mm, For IT 520 mm NL, Cab.600mm	1	Pc	4	2,384	73239390	
	9216607	9216607	CP Plain W 762mm, For IT 520 mm NL, Cab.900mm	1	Pc	4	3,375	73239390	
	CargoPlus (Thali Inlets)								
	9216608	9216608	CP Thali W 312mm, for IT 470mm NL, Cab.450mm	1	Pc	3	2,166	73239390	
	9216611	9216611	CP Thali W 312mm, for IT 520mm NL, Cab.450mm	1	Pc	3	2,236	73239390	
	9216614	9216614	CP Thali W 462mm, For IT 470mm NL, Cab.600mm	1	Pc	3	2,450	73239390	
	9216617	9216617	CP Thali W 462mm, For IT 520mm NL, Cab.600mm	1	Pc	3	2,590	73239390	
	CargoPlus (Plate Inlets)								
	9216609	9216609	CP Plate W 312mm, for IT 470mm NL, Cab.450mm	1	Pc	4	2,237	73239390	
	9216612	9216612	CP Plate W 312mm, for IT 520mm NL, Cab.450mm	1	Pc	4	2,307	73239390	
	9216615	9216615	CP Plate W 462mm, For IT 470mm NL, Cab.600mm	1	Pc	4	2,690	73239390	
	9216618	9216618	CP Plate W 462mm, For IT 520mm NL, Cab.600mm	1	Pc	4	2,826	73239390	
	CargoPlus (Cup & Saucer Inlets)								
	9216610	9216610	CP Cup & Saucer W 312mm, for IT 470mm NL, Cab.450 mm	1	Pc	6	2,130	73239390	
	9216613	9216613	CP Cup & Saucer W 312mm, for IT 520mm NL, Cab.450 mm	1	Pc	6	2,227	73239390	
	9216616	9216616	CP Cup & Saucer W 462mm, For IT 470mm NL, Cab.600 mm	1	Pc	6	2,563	73239390	
	9216619	9216619	CP Cup & Saucer W 462mm, For IT 520mm NL, Cab.600 mm	1	Pc	6	2,695	73239390	
	CargoPlus (Thali/Plate Inlets)								
	9216620	9216620	CP Thali/Plate W 762 mm, For IT 470 mm NL, Cab.900 mm	1	Pc	3	3,556	73239390	
	9216621	9216621	CP Thali/Plate W 762 mm, For IT 520 mm NL, Cab.900 mm	1	Pc	3	3,731	73239390	

Product	Article No.	SAP	Item Description	Qty.	Unit	PU	MRP	HS Code
CargoTech M (Plain Wire Basket - 500 mm depth) with KA clamps								
	9190382	9190382	CTM Plain (386x500x100) Cab.450 mm	1	Pc	6	1,865	73239390
	9190383	9190383	CTM Plain (386x500x150) Cab.450 mm	1	Pc	4	2,261	73239390
	9190384	9190384	CTM Plain (386x500x200) Cab.450 mm	1	Pc	3	2,571	73239390
	9190385	9190385	CTM Plain (436x500x100) Cab.500 mm	1	Pc	6	1,950	73239390
	9190386	9190386	CTM Plain (436x500x150) Cab.500 mm	1	Pc	4	2,303	73239390
	9190387	9190387	CTM Plain (436x500x200) Cab.500 mm	1	Pc	3	2,814	73239390
	9190388	9190388	CTM Plain (486x500x100) Cab.550 mm	1	Pc	6	2,051	73239390
	9190389	9190389	CTM Plain (486x500x150) Cab.550 mm	1	Pc	4	2,477	73239390
	9190390	9190390	CTM Plain (486x500x200) Cab.550 mm	1	Pc	3	2,942	73239390
	9190401	9190401	CTM Plain (536x500x100) Cab.600 mm	1	Pc	6	1,897	73239390
	9190402	9190402	CTM Plain (536x500x150) Cab.600 mm	1	Pc	4	2,277	73239390
	9190403	9190403	CTM Plain (536x500x200) Cab.600 mm	1	Pc	3	2,657	73239390
	9190404	9190404	CTM Plain (836x500x100) Cab.900 mm	1	Pc	6	2,805	73239390
	9190405	9190405	CTM Plain (836x500x150) Cab.900 mm	1	Pc	4	3,389	73239390
	9190406	9190406	CTM Plain (836x500x200) Cab.900 mm	1	Pc	3	4,018	73239390
CargoTech M (Thali Inlet)								
	9194315	9194315	CTM Thali (386x500x200) Cab.450 mm	1	Pc	3	2,798	73239390
	9194317	9194317	CTM Thali (436x500x200) Cab.500 mm	1	Pc	3	3,029	73239390
	9194319	9194319	CTM Thali (486x500x200) Cab.550 mm	1	Pc	3	3,299	73239390
CargoTech M (Cup & Saucer Inlet)								
	9194314	9194314	CTM Cup & Saucer (386x500x100) Cab.450 mm	1	Pc	6	2,333	73239390
CargoTech M (Saucer/Jar Inlet)								
	9194316	9194316	CTM Cup & Saucer/Jar (436x500x100) Cab.500 mm	1	Pc	6	2,611	73239390
	9194318	9194318	CTM Cup & Saucer/Jar (486x500x100) Cab.550 mm	1	Pc	6	3,173	73239390
	9194320	9194320	CTM Cup & Saucer/Jar (536x500x100) Cab.600 mm	1	Pc	6	3,173	73239390
CargoTech M (Thali/Jar Inlet)								
	9194321	9194321	CTM Thali/Jar (536x500x200) Cab.600 mm	1	Pc	3	3,373	73239390
CargoTech M (Thali/Plate/Jar Inlet)								
	9194322	9194322	CTM Thali/Plate/Jar (836x500x200) Cab.900 mm	1	Pc	3	4,773	73239390







Product	Article No.	SAP	Item Description	Qty.	Unit	PU	MRP	HS Code
	Moving Corner for blind corner cabinet, 900 / 1000 mm width							
	9221242	9221242	Moving Corner Cargo Series set of 4 baskets	1	Set	1	6,952	73239390
	9221243	9221243	Moving Corner Cargo Series Right mechanism	1	Pc	1	26,507	94039010
	9221244	9221244	Moving Corner Cargo Series Left mechanism	1	Pc	1	26,507	94039010
	Carousel							
	70549	9083464	Carousel D-1/2 for Ø750 Arena Classic	1	Set	1	36,170	94039010
	70550	9083480	Carousel D-1/2 for Ø850 Arena Classic	1	Set	1	38,945	94039010
	Carousel Cargo Series							
	9219462	9219462	Cargo 3/4 Carousel 2 Shelves 2 Flat Chrome White Base	1	Set	1	24,185	94039010
	9219465	9219465	Cargo 3/4 Carousel M 2 Shelves 1 Round Chrome White Base	1	Set	1	20,498	94039010
	CargoMan for Blind corner cabinet, 900/1000 mm width							
	9161971	9161971	450 LH (Double layer)	1	Set	1	31,601	94039010
	9161972	9161972	450 RH (Double layer)	1	Set	1	31,601	94039010
	9161973	9161973	500 LH (Double layer)	1	Set	1	34,138	94039010
	9161974	9161974	500 RH (Double layer)	1	Set	1	34,138	94039010
	Cargoman Soft Close for Blind corner cabinet, 900/1000 mm width							
	9218025	9218025	450 LH (Double layer)	1	Set	1	35,148	94039010
	9218026	9218026	450 RH (Double layer)	1	Set	1	35,148	94039010
	9218027	9218027	500 LH (Double layer)	1	Set	1	35,815	94039010
	9218028	9218028	500 RH (Double layer)	1	Set	1	35,815	94039010
	Cargoman M for Blind corner cabinet, 900/1000 mm width							
	9218021	9218021	450 LH (Double layer)	1	Set	1	25,474	94039010
	9218022	9218022	450 RH (Double layer)	1	Set	1	25,474	94039010
	9218023	9218023	500 LH (Double layer)	1	Set	1	29,188	94039010
	9218024	9218024	500 RH (Double layer)	1	Set	1	29,188	94039010
 Jar Rack  Multi Purpose Rack, 2-tier  Oil Container Rack  Saucer Rack  Kitchen Roll Holder  Railing	Cargo Midway Series							
	9217143	9217143	Jar Rack	1	Set	1	1,328	73239390
	9217145	9217145	Multi Purpose Rack, 2-tier	1	Set	1	1,328	73239390
	9217148	9217148	Oil Container Rack	1	Set	1	1,328	73239390
	9217179	9217179	Saucer Rack	1	Set	1	1,518	73239390
	9269987	9269987	Kitchen Roll Holder	1	Pc	1	1,518	73239390
	9267133	9267133	Railing Set, 600 mm	1	Set	1	2,562	83024200
	9267134	9267134	Railing Set, 900 mm	1	Set	1	3,075	83024200
	9267135	9267135	Railing Set, 1200 mm	1	Set	1	3,588	83024200
								

Product	Article No.	SAP	Item Description	Qty.	Unit	PU	MRP	HS Code
	Cleaning Utensil Pull-out							
	73549	9148880	Pull-out basket width (1 x 96) + (1 x 185)	1	Set	1	11,439	94039010
	Cargo IQ 200 (Bottle Pull out - 2 tier)							
	9161045	9161045	For Cabinet width 150 mm	1	Pc	4	6,571	73239390
	9161046	9161046	For Cabinet width 200 mm	1	Pc	3	7,725	73239390
	9161047	9161047	For Cabinet width 300 mm	1	Pc	2	8,875	73239390
	9160975	9160975	Quadro clamps (as per requirement)	1	Set	1	48	83024200
	1180142	1180142	Telescopic clamps (as per requirement)	1	Set	1	48	83024200
	73280	9209239	KA 5632, Zinc 450 mm	1	Set	1	389	83024200
	9114275	9114275	KA 4532, Silent 450 mm	1	Set	1	1,022	83024200
	45291-L	9099124	Quadro full Extn.Silent System 450 mm 30 kg	1	Pc	1	1,160	83024200
45291-R	9099125	Quadro full Extn.Silent System 450 mm 30 kg	1	Pc	1	1,160	83024200	
	Cargo IQ 300 (Bottle Pull out - 2 tier) - Compatible with KA runners only							
	9191703	9191703	For Cabinet width 150 mm	1	Pc	4	3,652	73239390
	9191708	9191708	For Cabinet width 200 mm	1	Pc	3	4,335	73239390
	9247908	9247908	For Cabinet width 240 mm	1	Pc	3	4,819	73239390
	9191711	9191711	For Cabinet width 300 mm	1	Pc	2	5,019	73239390
	1180142	1180142	Telescopic clamps (as per requirement)	1	Set	1	48	83024200
	73280	9209239	KA 5632, Zinc 450 mm	1	Set	1	389	83024200
	9114275	9114275	KA 4532, Silent 450 mm	1	Set	1	1,022	83024200
	Spice Pull Out 3 tier - Compatible with KA runners only							
	9210439	9210439	For Cabinet width 150 mm	1	Pc	4	4,346	73239390
	9210441	9210441	For Cabinet width 200 mm	1	Pc	3	4,950	73239390
	9210442	9210442	For Cabinet width 300 mm	1	Pc	2	5,426	73239390
	Square Bin Holder							
	9269984	9269984	Square Bin Holder 235 x 170x 205	1	Set	1	838	73239390
	9132377	9132377	8L Bin 152 x 225x 295	1	Set	1	1,197	39249000
	9132382	9132382	8L Lid (Grey) 152 x 225x 21	1	Set	1	496	39249000
	9132384	9132384	8L Lid (Green) 152 x 225x 21	1	Set	1	496	39249000
	Cargo Pull-Out Bin Holder							
	9269986	9269986	W300 234 x 495 x 315	1	Pc	1	2,547	73239390
	9269985	9269985	W600 (Below Sink) 536 x 225 x 205	1	Pc	1	2,034	73239390
	9132377	9132377	Bin 8L Plastic/grey	1	Pc	1	1,197	39249090
	9132380	9132380	Bin 17L Plastic/grey	1	Pc	1	1,795	39249090
	9132382	9132382	Lid 8L Plastic/grey	1	Pc	1	496	39249090
	9132384	9132384	Lid 8L Plastic/green	1	Pc	1	496	39249090
9132386	9132386	Lid 17L Plastic/grey	1	Pc	1	1,436	39249090	
	Cargo Pull-Out Bin Holder W600							
	9132382	9132382	Lid 8L Plastic/grey	1	Pc	1	496	39249090
	Cargo Pull-Out Bin Holder W600							
	9132384	9132384	Lid 8L Plastic/green	1	Pc	1	496	39249090
	Cargo Cylinder Trolley							
	9210445	9210445	Cylinder Trolley (Minimum cabinet width 400 mm)	1	Pc	1	1,396	73239390



















Product	Article No.	SAP	Item Description	Qty.	Unit	PU	MRP	HS Code
	Comfort Spin							
	9264627	9264627	Comfort Spin	1	Pc	1	6,667	39269097
	Cosario							
	9062032	9062032	600 mm width	1	Set	1	57,361	94039010
	9062035	9062035	900 mm width	1	Set	1	65,422	94039010
	Waterproof Mat							
	9079862	9079862	1200X580 Polystyrene, aluminium look	1	Pc	1	3,613	94039090
	Wicker Baskets with Wooden Runner							
	41895	41895	320 x 500 x 120 (cabinet width 400 mm)	1	Pc	1	7,416	46021091
	41898	41898	320 x 500 x 210 (cabinet width 400 mm)	1	Pc	1	7,194	46021091
	41902	41902	320 x 500 x 300 (cabinet width 400 mm)	1	Pc	1	7,541	46021091
	41896	41896	420 x 500 x 120 (cabinet width 500 mm)	1	Pc	1	7,783	46021091
	41899	41899	420 x 500 x 210 (cabinet width 500 mm)	1	Pc	1	7,349	46021091
	41903	41903	420 x 500 x 300 (cabinet width 500 mm)	1	Pc	1	7,961	46021091
	41897	41897	520 x 500 x 120 (cabinet width 600 mm)	1	Pc	1	8,272	46021091
	41901	41901	520 x 500 x 210 (cabinet width 600 mm)	1	Pc	1	7,809	46021091
	41904	41904	520 x 500 x 300 (cabinet width 600 mm)	1	Pc	1	9,210	46021091
	41906	41906	Beech Runner for cabinet side 18-19 mm (Order Beech runners separately)	1	Set	1	1,526	94039030
	Bin.it Classic							
	9154601	9154601	Body Stainless steel with Black plastic Bin, 13 litres capacity (Min. cabinet width 400 mm)	1	Set	1	3,349	73239990
9218233	9218233	Body White lacquered with White plastic Bin, 13 litres capacity (Min. cabinet width 400 mm)	1	Set	1	2,566	73239990	
	Bin.it Duo II - 300							
	9132343	9132343	Bin.it Duo II - 300	1	Set	1	16,461	39249000
	BIN.IT EASY 2x7.5l							
	9079929	9079929	BIN.IT EASY 2x7.5l	1	Set	1	11,227	39249000

Product	Article No.	SAP	Item Description			Qty.	Unit	PU	MRP	HS Code	
	Cargo Duo Basket Holder Frame		For outer cabinet width (mm)	For inside carcass width (mm)	Min. inside carcass height (mm)						
	9236364	9236364	450	410	1215 4-tier	1	Set	1	48,900	94039010	
	9236366	9236366	450	410	1800 6-tier	1	Set	1	50,477	94039010	
	9236365	9236365	600	560	1215 4-tier	1	Set	1	48,900	94039010	
	9236367	9236367	600	560	1800 6-tier	1	Set	1	50,477	94039010	
Pull out basket & Door shelf											
	9235979	9235979	For 450 mm cabinet width Pull Out Basket (360 x 220 x 90 mm) Door Shelf Basket (335 x 110 x 90 mm)			1	Set	2	1,841	73239390	
	9235980	9235980	For 600 mm cabinet width Pull Out Basket (510 x 220 x 90 mm) Door Shelf Basket (485 x 110 x 90 mm)			1	Set	2	2,307	73239390	
Cargo Larder Basket Holder											
	9236391	9236391	Cargo Larder Basket Holder			1	Set	1	315	94039010	
	Carcass outer width (mm) Full extension Runner 80 kg										
	9236381	9236381	Cargo Larder full ext. runner 300 mm (width)			1	Set	1	22,549	94039010	
	9236382	9236382	Cargo Larder full ext. runner 400 mm (width)			1	Set	1	22,549	94039010	
	9236383	9236383	Cargo Larder full ext. runner 450 mm (width)			1	Set	1	22,549	94039010	
Carcass outer width (mm) Full extension Runner 120 kg											
	9236386	9236386	Cargo Larder full ext. runner 300 mm (width)			1	Set	1	24,916	94039010	
	9236387	9236387	Cargo Larder full ext. runner 400 mm (width)			1	Set	1	24,916	94039010	
	9236388	9236388	Cargo Larder full ext. runner 450 mm (width)			1	Set	1	24,916	94039010	
Stainless Steel Baskets W x D x H (mm)											
	9235981	9235981	Stainless Steel Baskets 300 (230 x 435 x 115)			4	Pc	4	10,440	73239390	
	9235982	9235982	Stainless Steel Baskets 400 (330 x 435 x 115)			4	Pc	4	11,136	73239390	
	9235983	9235983	Stainless Steel Baskets 450 (380 x 435 x 115)			4	Pc	4	11,828	73239390	
Cargo Larder (Frame)											
			Min. inside carcass width	Carcass outer width							
	For Inside carcass height 1615 -1915 mm for 5 layers										
	9236379	9236379	262 (mm)		300 (mm)		1	Set	1	11,362	94039010
			362 (mm)		400 (mm)		1	Set	1	11,362	94039010
			412 (mm)		450 (mm)		1	Set	1	11,362	94039010
	For Inside carcass height 1880 -2180 mm for 6 layers										
	9236380	9236380	262 (mm)		300 (mm)		1	Set	1	11,362	94039010
			362 (mm)		400 (mm)		1	Set	1	11,362	94039010
			412 (mm)		450 (mm)		1	Set	1	11,362	94039010









Product	Article No.	SAP	Item Description	Qty.	Unit	PU	MRP	HS Code
	Garment Lift							
	9079878	9079878	Duo Lift 10 (10Kg) Inside cabinet width 750-1170 mm	1	Pc	1	5,629	83024200
	42507	42507	Duo Lift 15 (15Kg) Inside cabinet width 750-1150 mm	1	Pc	1	6,582	83024200
	9079882	9079882	Duo Lift 18 (18Kg) Inside cabinet width 750-1150 mm	1	Pc	1	9,342	83024200
	Wardrobe Tube & Wardrobe Tube Support							
	47615	47615	Oval cabinet rail 2000 mm Chrome Gloss	1	Pc	10	1,095	73066990
	70664	9056579	Cabinet rail Support SL 322 (3 screw holes)	1	Pc	10	30	83024200
	70666	9056573	Cabinet rail Support SL 323 (2 pins+1 screw hole)	1	Pc	10	35	83024200
	70668	70668	SI786 DD OVAL NICKEL	1	Pc	50	78	83024200
	Built-in Ironing Board							
45541	45541	Ironing Board Extension (Minimum inside cabinet width 360 - 468 mm)	1	Set	1	19,566	94039090	
	Shoe cabinet fitting							
42474	42474	Shoe cabinet fitting	1	Set	1	1,337	39263000	
	Cargo Pull Out Shoe Rack (Vertical)							
9209340	9209340	Cargo Pull Out Shoe Rack with accessory plate. For internal cabinet height 750 mm (W X D X H) - 279 x 500 x 580 mm (KA runner & clamps to be ordered separately)	1	Set	1	5,226	73262090	
	Cargo Pull Out Shoe Rack (Horizontal)							
	9217067	9217067	For 600 mm cabinet width with accessory plate.	1	Set	1	4,320	73262090
	9211635	9211635	For 900 mm cabinet width with accessory plate. (KA / Quadro runner & clamps to be ordered separately)	1	Set	1	5,409	73262090
	Pull Out Shelf							
	9209345	9209345	W 536 x D 500 x H 41, Cabinet 600 mm	1	Set	1	5,197	73262090
	9210438	9210438	W 686 mm x D 500 mm x H 41 mm Cab.750 mm	1	Set	1	5,839	73262090
	9209348	9209348	W 836 x D 500 x H 41, Cabinet 900 mm	1	Set	1	6,487	73262090

Product	Article No.	SAP	Item Description	Qty.	Unit	PU	MRP	HS Code
	Cargo Trousers Pull Out							
	9221098	9221098	Cargo trouser pull out (W X D X H) - 536 x 500 x 120 mm	1	Pc	1	7,264	73262090
	9236898	9236898	Cargo trouser pull out (W X D X H) - 836 x 500 x 120 mm (KA runner & clamps to be ordered separately)	1	Pc	1	8,277	73262090
	Cargo Trousers Pull Out M							
	9243990	9243990	Cargo trouser pull out (W X D X H) - 340 x 500 x 142 mm (KA runner & clamps to be ordered separately)	1	Pc	1	6,286	73262090
	Cargo Tie & Belt Pull Out							
	9221099	9221099	Cargo tie & belt pull out (W X D X H) - 125 x 500 x 100 mm (KA runner & clamps to be ordered separately)	1	Pc	1	6,216	73262090
	Cargo Tie & Belt Pull Out M							
	9243991	9243991	Cargo tie & belt pull out M (W X D X H) - 110 x 500 x 68 mm (KA runner & clamps to be ordered separately)	1	Pc	1	5,238	73262090
	Cargo wall shoe rack (M)							
	9243992	9243992	Cargo wall shoe rack (M) (W X D X H) - 500 x 210 x 238 mm (KA runner & clamps to be ordered separately)	1	Pc	1	3,452	73262090
	Cargo Laundry							
	9241012	9241012	Cargo Laundry (W X D X H) - 220 x 500 x 580 mm (KA runner & clamps to be ordered separately)	1	Pc	1	5,110	73262090

Product	Article No.	SAP	Item Description	Qty.	Unit	PU	MRP	HS Code
Shelf Supports								
	16180	16180	Safety 5 mm Translucent.	100	Pc	1000	300	83024200
	25090	9127419	Safety 5 mm White	100	Pc	1000	300	83024200
	53012	1011027	Sekura7 Nickel	100	Pc	1000	1,200	83024200
	22737	1006203	Universal D Nickel	100	Pc	1000	600	83024200
	25100	9010111	Sekura2 Nickel	100	Pc	1000	700	83024200
	79707	9005558	Support Sekura6 Nickel	100	Pc	1000	1,200	83024200
	19557	9010110	Sekura1.1 Nickel	100	Pc	1000	800	83021090
	79709	1056163	PVC/Steel 5 mm for Glass shelf	100	Pc	1000	300	83024200
	47609	1010564	Sekura8 Nickel for Glass shelf	100	Pc	1000	1,500	83024200
	47661	1069728	Titan min. shelf thickness 24 mm	1	Pc	20	96	83024200
Suspension Brackets								
	79724-L	1066278	SAH 130 Steel/PVC White Left	1	Pc	25	66	83024200
	79724-R	1066279	SAH 130 Steel/PVC White Right	1	Pc	25	66	83024200
	79725-L	1066339	Cover Cap Left For SAH 130 White	100	Pc	25	900	39269097
	79725-R	1066338	Cover Cap Right For SAH 130 White	100	Pc	25	900	39269097
	9007651	9000169	Rail B 3000 mm Zinc	1	Pc	1	839	83024200
	9208678	9208678	Rail L 130 mm Zinc	1	Pc	1	78	83024200
	46103	46103	Suspension Hook Ø6 X 50 mm + Wall pulg Ø8 X 40 mm	100	Pc	100	1,893	83024200
	65480	65480	Special screw Ø5.5 x 50 mm + Wall pulg Ø8 X 40 mm	100	Pc	100	2,000	83024200
	19476	19476	Cabinet Suspension SAH 16 Nickel	1	Set	25	300	83024200
Rastex- 3 Part Set								
	13958	9056601	Rastex 15/18 Zinc/Nickel Cam	100	Pc	2000	600	83024200
	20157	9047865	Twister screw in Dowel DU644 - M6 x 7.8 mm	100	Pc	2000	500	73181499
	79539	1004928	Socket No.33 - 10 mm, Plastic	100	Pc	5,000	300	39269097





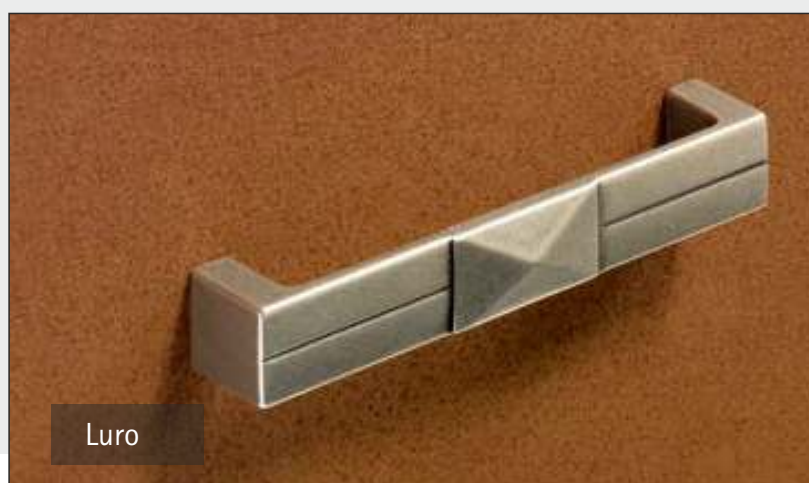

Product	Article No.	SAP	Item Description	Qty.	Unit	PU	MRP	HS Code
	Rastex- 2 Part Set							
	13958	9056601	Rastex 15/18 Zinc/Nickel Cam	100	Pc	2000	600	83024200
	20058	9047861	Twister screw in Dowel DU 232T - Ø 5 mm	100	Pc	2000	500	73181499
	Rastex Cover Cap for Rastex 15 without rim							
	71054	1008524	Cover Cap Rastex 15 White	100	Pc	5000	92	39269097
	71055	1008525	Cover Cap Rastex 15 Brown	100	Pc	5000	92	39269097
	79490	1009563	Cover Cap Rastex 15 Black	100	Pc	5000	92	39269097
	Rastex Misc.							
	40005	1004925	Socket (Plastic) no. 49 M6 - 8 mm	100	Pc	10000	200	39269097
	79529	1004927	Socket (Plastic) no. 30 M4 - 8 mm	100	Pc	5000	245	39263000
	79458	9064684	Rastex (Cam) 15/15 nickel plated.	100	Pc	2000	600	83024200
	13962	9056599	Rastex 15 without rim/18 Bright	100	Pc	2000	725	83024200
	79568	1079580	Double Dowel Du853 chrome with seeger circle ring	1	Pc	2000	27	83024200
	48578	48578	Expanding Socket M4 Brass 5 mm	100	Pc	2000	561	83024200
	Rapid Dowels							
	44759	9046186	Rapid S DU 332-10 mm stern 30 mm	100	Pc	200	623	73182900
	9046182	9046182	Rapid S DU 332-8 mm Stern 30 mm	100	Pc	2000	629	73182900
	Rostrino							
	9131207	9131207	Rostrino 12 mm	1	Pc	250	264	83024200
	9132011	9132011	Brush for Rostrino 12 mm	1	Pc	250	27	83024200
	VB Connectors							
	47454	47454	VB 21 for 19 - 20 mm shelves, without rib.	1	Pc	200	58	83024200
	65529	9143778	VB 36 / 19 for 19 mm shelves, without rib nickel plated	1	Pc	200	52	83024200
	25052	9039828	Screw in dowel DU 327 Steel Bright, Drill dia 5 mm	100	Pc	2000	600	73181499
	65515	9116929	VB 35 / 19 for 19 mm shelves, without rib. White	1	Pc	200	14	94039010
	65513	9143776	VB 35 / 19 for 19 mm shelves, without rib. nickel plated	1	Pc	200	46	83024200
	74688	74688	Screw in dowel DU 321, Drill dia 5 mm	100	Pc	2000	700	83024200
	65370	65370	Screw-in dowel DU 426, Drill dia 5 mm	100	Pc	200	875	83024200

Product	Article No.	SAP	Item Description	Qty.	Unit	PU	MRP	HS Code
Connectors Misc.								
	9039828	9039828	DU 265 Dowel Steel Bright	100	Pc	2000	600	73181499
	48586	48586	Cone-Shaped Plug Ø5 white	100	Pc	2000	100	39263000
	1996097	1996097	Socket M6 WZ.LJ205A	100	Pc	2000	500	73181500
	51265	51265	Direct Fixing Screws Shallow countersunk head	100	Pc	200	300	73181558
	79438	79438	Rear-panel connector RV 8	100	Pc	200	600	94039090
	44744	44744	Connecting Plate 200 mm	1	Pc	50	94	83024200
	48590	48590	Cover Cap 10 mm Plastic, White	100	Pc	1000	92	39263000
	9084240	9084240	Parquet floor glides for screwing on 20 mm	100	Pc	100	2,400	39263000
Direkta Screws								
	19556	1005109	Direkta 2 6.3 x50 mm chr. PI PZ (1000/ctn)	100	Pc	1000	400	73181290
	1005457	1005457	Cover Cap Ø3 White	100	Pc	5000	200	39269097
Franke Fittings								
	9060089	9060089	Franko-Flex 90°, 10 Positions (44745)	1	Pc	100	632	83024200
	9130900	9130900	Cover Cap Chrome for Round Link Vario-Flex	1	Pc	100	138	83024200
	9125137	9125137	Vario-Flex 0-90° with Round Link Chromed	1	Pc	100	756	83024200
	9125138	9125138	Vario-Flex 270-360° with Round Link Chromed	1	Pc	100	756	83024200
Cabinet Connector								
	79659	1072394	VHS 32/35 28-36 mm	100	Pc	1000	400	73181692
	79660	1072393	VHS 32/35 36-44 mm	100	Pc	1000	500	73181900
	1058986	1058986	VHS Screw SMG M4x15	100	Pc	2000	200	73181558
	9157165	9157165	VS 34 34-45 mm Wood Thickness, White	10	Pc	100	1,560	73181558
	8956	8956	VS 49 49-56 mm Wood Thickness, White	100	Pc	100	1,600	39263000
Misc Fittings								
	46080	1009684	Multi-Clip PVC Black	100	Pc	200	2,000	39263000
	79665	9113735	Universal angle 31x31 mm	100	Pc	1000	1,500	83024200
	25197	9113741	Universal Angle 41x41 mm	100	Pc	100	1,600	83024200

Product	Article No.	SAP	Item Description	Qty.	Unit	PU	MRP	HS Code
	Plastic Socket							
	48577	1004932	Expanding Socket 43 Ø5 L13 PL	100	Pc	10000	200	39269097
	48576	1004933	Expanding Socket 66 Ø5 L9 PL	100	Pc	10000	200	39269097
	45169	1001097	T43 Hinge Screws Ø10 x 11 mm	100	Pc	1000	400	39269097
	1058613	1058613	T43 Hinge Sockets Ø10 mm	100	Pc	1000	500	39269097
	Wooden Dowel							
	9290706	9290706	Wooden Dowel 8.0 X 30 mm	100	Pc	2000	100	44219999
	69241	9102465	Wooden Dowel 8.0 X 40 mm	100	Pc	2000	100	44219999
	9290707	9290707	Wooden Dowel 8.0 X 50 mm	100	Pc	2000	140	44219999
	9290708	9290708	Wooden Dowel 6.0 X 35 mm	100	Pc	4000	100	44219999
	Magnetic Catches							
	13142	13142	M72/GP2, 4 kg holding force, Brown	1	Pc	50	49	85051100
	Locks							
	43635	43635	Multi-Purpose Square Lock 22mm - 200 KC	1	Set	100	204	83013000
	9287293	9287293	Multi-Purpose Square Lock 22mm - 200 KC with Master Key	1	Set	200	204	83013000
	9110389	9110389	Multi-Purpose Square Lock 32mm - 200 KC	1	Set	100	239	83013000
	9219182	9219182	Multi-Purpose Square Lock 22mm - 400 KC	1	Set	100	213	83013000
	9246395	9246395	Multi-Purpose Square Lock 22mm - 400 KC with Foldable Et Master key	1	Set	100	241	83013000
	9259400	9259400	Multi-drawer Pedestal Lock 22 mm - 200 KC	1	Set	100	170	83013000
	9287294	9287294	Multi-drawer Pedestal Lock 22mm - 200 KC with Master Key	1	Set	200	177	83013000
	9236413	9236413	Multi-drawer Pedestal Lock 22 mm - 200 KC with Foldable key with rod	1	Set	100	373	83013000
	9219491	9219491	Multi-drawer Pedestal Lock 22 mm-400 KC with rod	1	Set	100	368	83013000
	9289652	9289652	Multi-drawer Pedestal Lock 22 mm - 400 KC with Foldable Key and Master Key	1	Set	200	173	83013000
	9246396	9246396	Multi-drawer Pedestal lock 22 mm - 400 KC with foldable and Master Key without Rod	1	Set	100	293	83013000
	9259415	9259415	MD Lock Accessories Et Rod	1	Set	100	172	83013000
30125	30125	Stop bracket Type-3011	10	Pc	100	350	83013000	
	Cylinder Cam Lock							
	9227175	9227175	Cylinder cam lock Fix Barrel 200KC - Flat cam	1	Set	200	173	83013000
	9227176	9227176	Cylinder cam lock Fix Barrel 200KC - 2 mm crank	1	Set	200	173	83013000
	9227177	9227177	Cylinder cam lock Fix Barrel 200KC -11 mm crank	1	Set	200	173	83013000
	Push Lock							
	9180613	9180613	Push-Lock 22mm 200 KC with Master Key	1	Set	200	183	83013000
	9182732	9182732	Push-Lock 32mm 200 KC with Master Key	1	Set	200	226	83013000



Product	Article No.	SAP	Item Description	Qty.	Unit	PU	MRP	HS Code
	Espagnolette Cabinet Lock For 20 mm Doors Upto 8 ft							
	9136128	9136128	Prestige 2000 Set Z23 Dia 18 mm - 20 mm	1	Set	10	1,455	83013000
	72251	72251	Espagnolette rod 1000 mm length	1	Set	10	232	83013000
	72253	72253	Espagnolette rod 1500 mm length	1	Set	10	352	83013000
	9078861	9078861	Lock Barrel+Keys Z23 18001-18050	1	Set	10	577	83013000
			Total				2,616	
	Espagnolette Cabinet Lock For 26 mm Doors Upto 8 ft							
	9154261	9154261	Prestige 2000 Set Z23 Dia 18 mm - 26 mm	1	Set	10	1,497	83013000
	72251	72251	Espagnolette rod 1000 mm length	1	Set	10	232	83013000
	72253	72253	Espagnolette rod 1500 mm length	1	Set	10	352	83013000
	9078861	9078861	Lock Barrel+Keys Z23 18001-18050	1	Set	10	577	83013000
			Total				2,658	
	Cylinder Lock Set for 3-Door Sliding-Door Cabinets (Max Door Width=1200 mm; Thickness 20-22 mm)							
	9133927	9133927	3 Door Sliding Lock Set Z23 Dia 18 mm	1	Set	10	2,151	83013000
	9078861	9078861	Lock Barrel+Keys Z23 18001-18050	1	Set	10	577	83013000
			Total				2,728	
	Cylinder Lock Set for 2-Door Sliding-Door Cabinets (Max Door Width=1500 mm; Thickness 20-28 mm)							
	9133926	9133926	2 Door Sliding Lock Set Z23 Dia 18 mm	1	Set	10	1,506	83013000
	9078861	9078861	Lock Barrel+Keys Z23 18001-18050	1	Set	10	577	83013000
			Total				2,083	
	48259	48259	Automatic Door Bolt Nickel	1	Pc	10	693	83013000
	Euro Adjustable Legs							
	40438	40438	Base Adjustable Stop 60-80 A	1	Pc	100	386	39263000
	71840	71840	Euro-Base Adjustable 100 mm	1	Pc	100	43	39263000
	71841	71841	Euro-Base Adjustable 130 mm	1	Pc	100	54	39263000
	71842	71842	Euro-Base Adjustable 150 mm	100	Pc	100	4,700	39263000
	71847	71847	Euro-PC Fixing Block Screw-On.	1	Pc	100	30	39263000
	71845	71845	Euro-PC Clips Screw-On	100	Pc	100	700	39263000
	9020484	9020484	Euro-Base Plinth Plate Screw-On Self Colour	100	Pc	100	300	39263000
	Blue Max Mini Machine							
	20264	9238684	Blue Max Mini T2/6 230V 50 HZ 1 PH	1	Pc	1	55,410	84651010
	20485	20485	Fence Extension with Scale	1	Set	1	2,550	84669200
	20486	20486	Holder For Fence Extension	1	Set	1	1,720	84669200
	20487	20487	Set Of Fixed Stop	1	Set	1	670	84669200
	20488	20488	Pendulum Stop For Fence- 61265	2	Set	2	1,160	84669200
	20490	20490	Set Of Drill Bits For Hinges	1	Set	1	3,920	82075060
	20492	20492	Set Of Drill Bits For VB 18/19/20/21	2	Set	2	6,440	82075060
	20498	20498	Drill Bit D. 5 mm Left Hand	2	Pc	2	1,200	82075060
	20499	20499	Drill Bit D. 2 mm Left Hand	2	Pc	2	1,920	82075060
	9242840		Total				74,990	



Product	Article No.	SAP	Hole Distance	Finish	Qty.	Unit	PU	MRP	HS Code
Econ Handle									
Adonia 	1180122	1180122	96	Nickel Matt	1	Pc	200	63	83024200
	1180121	1180121	128	Nickel Matt	1	Pc	150	95	83024200
Alano 	1180167	1180167	96	Nickel Matt	1	Pc	200	75	83024200
	1180166	1180166	128	Nickel Matt	1	Pc	125	111	83024200
Ancona 	9995081	1161173	96	Nickel Matt	1	Pc	200	82	83024200
	9995077	1161167	128	Nickel Matt	1	Pc	150	122	83024200
Agacia 	9220976	9220976	96	Nickel Matt	1	Pc	50	69	83024200
	9220978	9220978	128	Nickel Matt	1	Pc	50	108	83024200
Agacia 	9220975	9220975	96	Bright Chrome	1	Pc	50	62	83024200
	9220977	9220977	128	Bright Chrome	1	Pc	50	99	83024200
Andera 	9220980	9220980	96	Nickel Matt	1	Pc	50	64	83024200
	9220982	9220982	128	Nickel Matt	1	Pc	50	112	83024200
Andera 	9220979	9220979	96	Bright Chrome	1	Pc	50	58	83024200
	9220981	9220981	128	Bright Chrome	1	Pc	50	103	83024200

Product	Article No.	SAP	Hole Distance	Finish	Qty.	Unit	PU	MRP	HS Code
ProDecor Handles									
Baldone 	9995780	1161398	160	Bright Chrome	1	Pc	30	204	83024200
	9995781	1161399	160	Stainless steel	1	Pc	30	456	83024200
Evisa 	9113502	9113502	128	Stainless steel	1	Pc	30	456	83024200
	9113501	9113501	128	Bright Chrome	1	Pc	30	212	83024200
Neapolis 	115122	9160301	96	Bright Chrome	1	Pc	25	768	83024200
Salona 	1170155	1170155	160	Stainless steel	1	Pc	30	282	83024200
Tolfo 	9097900	9097900	32	Bright Chrome	1	Pc	25	1156	83024200
Tolosa 	9113514	9113514	128	Nickel Matt	1	Pc	25	252	83024200
Calisia 	9125758	9125758	128	Anodised Aluminum	1	Pc	50	688	83024200
Intra 	9113800	9113800	192	Bright Chrome	1	Pc	25	1033	83024200
clivia 	115353	9125415	160	Anodised Aluminum	1	Pc	50	1,369	83024200
	115208	9125407	288	Anodised Aluminum	1	Pc	25	1,615	83024200
clivia 	115214	9125412	544	Anodised Aluminum	1	Pc	25	2,241	83024200
	115217	9125427	2x 564	Anodised Aluminum	1	Pc	20	2,306	83024200
Parma 	9113468	9113468	128	Bright Chrome	1	Pc	50	475	83024200
Novae 	9112634	9112634	-	Bright Chrome	1	Pc	100	312	83024200
Suasa 	9112916	9112916	160	Bright Chrome	1	Pc	25	852	83024200
Messana 	115156	9211116	32	Brushed Stainless Steel	1	Pc	50	297	83024200

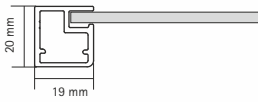
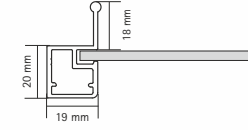
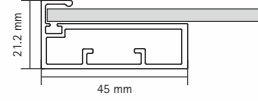
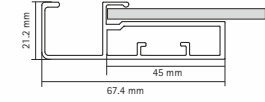
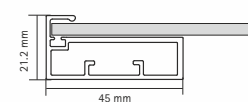
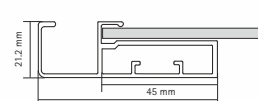
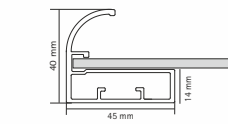
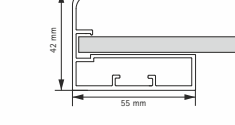
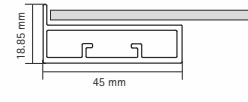
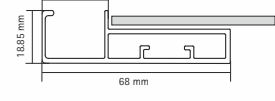
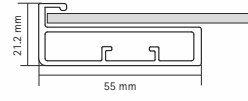
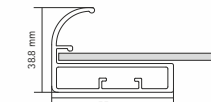
Product	Article No.	SAP	Hole Distance	Finish	Qty.	Unit	PU	MRP	HS Code
Lamezia 	9247827	9247827	145	Bright chrome	1	Pc	25	476	83024200
	9247828	9247828	195	Bright chrome	1	Pc	25	588	83024200
	9105801	9105801	295	Bright chrome	1	Pc	25	1,462	83024200
	9105802	9105802	345	Bright chrome	1	Pc	25	1,608	83024200
	9105803	9105803	395	Bright chrome	1	Pc	25	1,898	83024200
	9105805	9105805	445	Bright chrome	1	Pc	25	2,082	83024200
	9105806	9105806	495	Bright chrome	1	Pc	25	2,299	83021090
	9105807	9105807	595	Bright chrome	1	Pc	25	2,743	83024200
	9105809	9105809	795	Bright chrome	1	Pc	25	3,441	83024200
	9105810	9105810	895	Bright chrome	1	Pc	25	1,811	83024200
	9105811	9105811	995	Bright chrome	1	Pc	25	1,957	83024200
	9105813	9105813	1195	Bright chrome	1	Pc	25	2,139	83024200
Lamezia 	9248726	9248726	145	Stainless steel	1	Pc	25	344	83024200
	9248727	9248727	195	Stainless steel	1	Pc	25	428	83024200
	9105815	9105815	295	Stainless steel	1	Pc	25	1,243	83024200
	9105816	9105816	345	Stainless steel	1	Pc	25	1,302	83024200
	9105819	9105819	395	Stainless steel	1	Pc	05	1,448	83024200
	9105820	9105820	445	Stainless steel	1	Pc	05	1,536	83024200
	9105821	9105821	495	Stainless steel	1	Pc	05	1,770	83021090
	9105822	9105822	595	Stainless steel	1	Pc	05	1,974	83024200
	9105823	9105823	795	Stainless steel	1	Pc	25	2,502	83024200
	9105824	9105824	895	Stainless steel	1	Pc	05	2,910	83024200
	9105825	9105825	995	Stainless steel	1	Pc	25	1,957	83024200
	9105826	9105826	1195	Stainless steel	1	Pc	25	2,139	83024200
Lamezia 	9247829	9247829	145	Anodised aluminium	1	Pc	25	314	83024200
	9247830	9247830	195	Anodised aluminium	1	Pc	25	392	83024200
	9105827	9105827	295	Anodised aluminium	1	Pc	25	893	83024200
	9105828	9105828	345	Anodised aluminium	1	Pc	25	951	83024200
	9105829	9105829	395	Anodised aluminium	1	Pc	25	1,097	83024200
	9105830	9105830	445	Anodised aluminium	1	Pc	25	738	83024200
	9105831	9105831	495	Anodised aluminium	1	Pc	25	1,419	83021090
	9105832	9105832	595	Anodised aluminium	1	Pc	25	992	83024200
	9105833	9105833	795	Anodised aluminium	1	Pc	25	1,320	83024200
	9105834	9105834	895	Anodised aluminium	1	Pc	25	2,530	83024200
	9105835	9105835	995	Anodised aluminium	1	Pc	25	1,721	83024200
	9105836	9105836	1195	Anodised aluminium	1	Pc	25	1,866	83024200



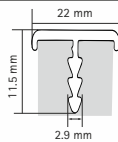
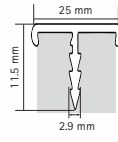
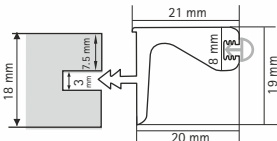

Product	Product Section	Glass Thickness	Width	Finish	Article No.	SAP	Unit	PU	MRP	HS Code
19 mm Straight Frame Profile 3000 mm		4 mm	19 mm	SA	9288843	9288843	Pc	04	1,186	76042990
19 mm Straight Frame Profile with handle 3000 mm		4 mm	19 mm	SA	9283472	9283472	Pc	04	1,390	76042990
45 mm (Econ) Straight Frame Profile for small shutters 3000 mm		4 mm	45 mm	SA	9283532	9283532	Pc	04	1,402	76042990
45 mm (Econ) Straight Frame Profile with L Handle for small shutters 3000 mm		4 mm	45 mm	SA	9283533	9283533	Pc	04	1,876	76042990
45 mm Straight Frame Profile 3000 mm		4 mm	45 mm	SA	9283473	9283473	Pc	04	1,673	76042990
				SS	9283481	9283481	Pc	04	2,969	76042990
45 mm Straight Frame Profile with L Handle 3000 mm		4 mm	45 mm	SA	9283485	9283485	Pc	04	2,193	76042990
				SS	9153794	9153794	Pc	04	3,599	76042990
45 mm Straight Frame Profile with C Handle 3000 mm		4 mm	45 mm	SA	9283474	9283474	Pc	04	2,207	76042990
45 mm Straight Frame Profile with F Handle 3000 mm		4 mm	45 mm	SA	9148134	9283494	Pc	04	2,605	76042990
45 mm Straight Stick-On Frame Profile 3000 mm		4 mm	45 mm	SA	9283488	9283488	Pc	04	1,390	76042990
45 mm Straight Stick-On Frame Profile with L handle 3000 mm		4 mm	45 mm	SA	9283487	9283487	Pc	05	2,003	76042990
55 mm Straight Frame Profile 3000 mm		4 mm	55 mm	SA	9288842	9288842	Pc	04	2,099	76042990
55 mm Straight Frame Profile with C Handle 3000 mm		4 mm	55 mm	SA	9288844	9288844	Pc	04	2,541	76042990
Angle Connector Set (For all aluminum profiles)		1 Set Consists of 4 connectors & 8 screws			13684	13684	Set	20	110	83024200

• CP - Chrome finish • SS - Stainless steel finish • SA - Silver finish • CH - Champagne Finish

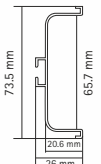
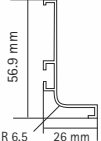
Item Description	Profile Section	Suitable for (mm)	Width (mm)	Finish	Article No.	SAP	Unit	PU	MRP	HS Code
Edge Profile										
Edge Profile (22 mm) 3000 mm		19 mm board thickness		SA	9283498	9283498	Pc	08	444	76042990
				SS	9283499	9283499	Pc	08	510	76042990
Edge Profile (25 mm) 3000 mm		22 mm board thickness		SA	9283500	9283500	Pc	08	472	76042990
				SS	9283501	9148143	Pc	08	543	76042990
Edge Profile for Wall cabinet 3000 mm		18 mm board thickness onwards		SA	9283517	9283517	Pc	12	1,001	76042990
				SS	9283518	9283518	Pc	12	1,242	76042990

• CP – Chrome finish • SS – Stainless steel finish • SA – Silver finish • CH – Champagne Finish

Product	Product Section	Length (mm)	Finish	Article No.	SAP	Unit	PU	MRP	HS Code
Gola Profile									
Gola profile C Type		3000	SA	9283515	9283515	Pc	10	1,205	76042990
			SS	9283512	9283512	Pc	10	1,576	76042990
Gola profile L Type		3000	SA	9283516	9283516	Pc	10	1,001	76042990
			SS	9283514	9283514	Pc	10	1,279	76042990

Item Description	Product	Compatible with	Side	Article No.	SAP	Unit	PU	MRP	HS Code
Gola Profile Accessories									
Gola Profile End Cap for C Type with screws		SA & CP	Left	9212563	9212563	Pc	20	277	76042990
			Right	9212564	9212564	Pc	20	277	76042990
		SS	Left	9218244	9218244	Pc	20	278	76042990
			Right	9218245	9218245	Pc	20	278	76042990
Gola Profile End Cap for L Type with screws		SA & CP	Left	9212565	9212565	Pc	20	277	76042990
			Right	9212566	9212566	Pc	20	277	76042990
		SS	Left	9218246	9218246	Pc	20	278	76042990
			Right	9218247	9218247	Pc	20	278	76042990
Gola Outer Angle Profile Connector with screws		SA & CP		9212567	9212567	Pc	20	277	76042990
		SS		9218248	9218248	Pc	20	278	76042990
Gola Inner Angle Profile Connector with screws		SA & CP		9212568	9212568	Pc	20	376	76042990
		SS		9218269	9218269	Pc	20	376	76042990
Gola L Connector set with screws		-		9220600	9220600	Pc	20	46	76042990

Product	Product Section	Details	Finish	Article No.	SAP	Unit	PU	MRP	HS Code
Handle Eslinga (G Profile)		Profile height 40 mm & Length 3000 mm	SA	9283502	9283502	Pc	04	2,240	76042990
Eslinga Econ (G Profile)		Profile height 35 mm & Length 3000 mm	SA	9283503	9283503	Pc	04	1,631	76042990
			SS	9216238	9216238	Pc	04	2,041	76042990
Lutetia		Profile height 28 mm & Length 3000 mm	SA	9133756	9133756	Pc	04	1,409	76042990
Spira		Profile Ht- 43 mm & Length 2000 mm	SA	115314	9126106	Pc	04	1,515	76042990
		End Cap	-	115298	9126165	Pc	20	277	83024200
Calisia		Length 1950 mm	SA	115105	9125763	Pc	08	2,219	76042990
Lindavia		for 19 mm board & Length 2000 mm	SA	115115	9125832	Pc	12	1,559	94039000
Ticinum		Length 2000 mm	SA	9131455	9131455	Pc	12	3,284	76042990
Seveso		Profile height 38mm for 19 mm thickness & Length 2400 mm	SA	9995123	1161200	Pc	06	1,001	76042990

• CP - Chrome finish • SS - Stainless steel finish • SA - Silver finish • CH - Champagne Finish

Product	Product Section	Length (mm)	Finish	Article No.	SAP	Unit	PU	MRP	HS Code
Gola Profile									
Gola profile (Vertical application)		3000	SA	9293474	9293474	Pc	4	1,795	76042990
Gola profile (Vertical application)		3000	SA	9293473	9293473	Pc	4	1,595	76042990

Product	Product Section	Length (mm)	Finish	Article No.	SAP	Unit	PU	MRP	HS Code
Sink Counter Profile With Connectors									
Sink counter profile		3000	SA	9293475	9293475	Pc	6	1,111	76042990
Bracket for sink counter profile left		-	-	9293678	9293678	Pc	50	26	76042990
Bracket for sink counter profile right		-	-	9293678	9293678	Pc	50	26	76042990

HETTICH – Countersunk Saw Thread

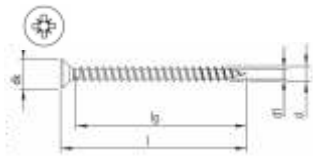

Material
Finish
Head
Drive
Thread
Packing

Steel
Zinc Coated
Countersunk
Pozi Drive
Saw
Small/Retail

Dimension	Gauge	Article no.	SAP	Unit	PU	MRP/100	HS Code
Ø3 x 12	5	9162378	9162378	Pc	1000	63	73181200
Ø3 x 12	5	9169370	9169370	Pc	1000	65	73181200
Ø3.5 x 12	6	9148092	9148092	Pc	1000	65	73181200
Ø3.5 x 16	6	9137980	9137980	Pc	1000	68	73181200
Ø3.5 x 20	6	9153820	9153820	Pc	1000	72	73181200
Ø3.5 x 25	6	9162379	9162379	Pc	1000	82	73181200
Ø3.5 x 30	6	9162380	9162380	Pc	1000	95	73181200
Ø3.5 x 35	6	9169371	9169371	Pc	1000	103	73181200
Ø3.5 x 40	6	9162381	9162381	Pc	500	115	73181200
Ø4.0 x 12	8	9169372	9169372	Pc	1000	72	73181200
Ø4.0 x 16	8	9137992	9137992	Pc	1000	82	73181200
Ø4.0 x 20	8	9137991	9137991	Pc	1000	86	73181200
Ø4.0 x 25	8	9137993	9137993	Pc	1000	97	73181200
Ø4.0 x 30	8	9140272	9140272	Pc	1000	112	73181200
Ø4.0 x 35	8	9140274	9140274	Pc	500	131	73181200
Ø4.0 x 40	8	9140275	9140275	Pc	500	142	73181200
Ø4.0 x 45	8	9140276	9140276	Pc	500	152	73181200
Ø4.0 x 50	8	9169373	9169373	Pc	500	165	73181200
Ø5.0 x 50	10	9148093	9148093	Pc	200	297	73181200
Ø5.0 x 60	10	9153821	9153821	Pc	200	342	73181200
Ø5.0 x 70	10	9153822	9153822	Pc	200	408	73181200
Ø5.0 x 80	10	9169376	9169376	Pc	100	489	73181200
Ø5.0 x 90	10	9169378	9169378	Pc	100	588	73181200
Ø5.0 x 100	10	9169380	9169380	Pc	100	685	73181200

HETTICH – Zinc Countersunk Industrial Packing

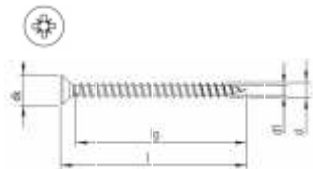

Material
Finish
Head
Drive
Thread
Packing

Steel
Zink
Countersunk
Pozi Drive
Saw
Industrial

Dimension	Gauge	Article no.	SAP	Unit	PU	MRP/100	HS Code
Ø3.5 x 12	6	9200221	9200221	Pc	28000	51	73181200
Ø3.5 x 16	6	9200222	9200222	Pc	25000	51	73181200
Ø3.5 x 20	6	9200223	9200223	Pc	20000	55	73181200
Ø4.0 x 16	8	9200224	9200224	Pc	17000	62	73181200
Ø4.0 x 20	8	9200225	9200225	Pc	15000	65	73181200
Ø4.0 x 25	8	9200226	9200226	Pc	13000	75	73181200
Ø4.0 x 30	8	9200227	9200227	Pc	10000	86	73181200
Ø4.0 x 35	8	9200228	9200228	Pc	9000	95	73181200
Ø5.0 x 50	10	9200252	9200252	Pc	4500	194	73181200

HETTICH – Pan head Saw Thread

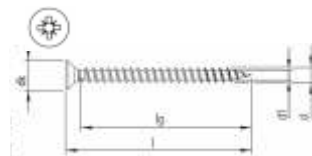

Material
Finish
Head
Drive
Thread
Packing

Steel
Zinc Coated
Pan head
Pozi Drive
Saw
Retail

Dimension	Gauge	Article no.	SAP	Unit	PU	MRP/100	HS Code
Ø4.0 x 16	8	9137999	9137999	Pc	1000	82	73181200
Ø4.0 x 30	8	9169386	9169386	Pc	500	131	73181200

HETTICH – Stainless Steel CounterSunk Saw thread

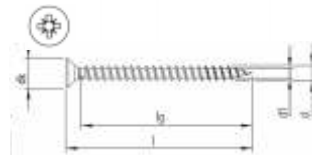

Material
Finish
Head
Drive
Thread
Packing

Magnetic
-
Countersunk
Pozi Drive
Saw
Retail

Dimension	Gauge	Article no.	SAP	Unit	PU	MRP/100	HS Code
Ø3.5 x 12	6	9162382	9162382	Pc	1000	108	73181200
Ø3.5 x 16	6	9154452	9154452	Pc	1000	122	73181200
Ø3.5 x 20	6	9162383	9162383	Pc	1000	138	73181200
Ø3.5 x 25	6	9162384	9162384	Pc	1000	169	73181200
Ø3.5 x 30	6	9162385	9162385	Pc	1000	183	73181200
Ø3.5 x 35	6	9162386	9162386	Pc	1000	214	73181200
Ø4.0 x 16	8	9162388	9162388	Pc	1000	154	73181200
Ø4.0 x 20	8	9154453	9154453	Pc	1000	176	73181200
Ø4.0 x 25	8	9154454	9154454	Pc	1000	209	73181200
Ø4.0 x 30	8	9154455	9154455	Pc	1000	242	73181200
Ø4.0 x 35	8	9154456	9154456	Pc	500	265	73181200
Ø4.0 x 40	8	9162389	9162389	Pc	500	315	73181200
Ø5.0 x 50	10	9154459	9154459	Pc	200	592	73181200
Ø5.0 x 60	10	9169394	9169394	Pc	200	726	73181200
Ø5.0 x 70	10	9154461	9154461	Pc	200	760	73181200

HETTICH – Handle Fixing Screws







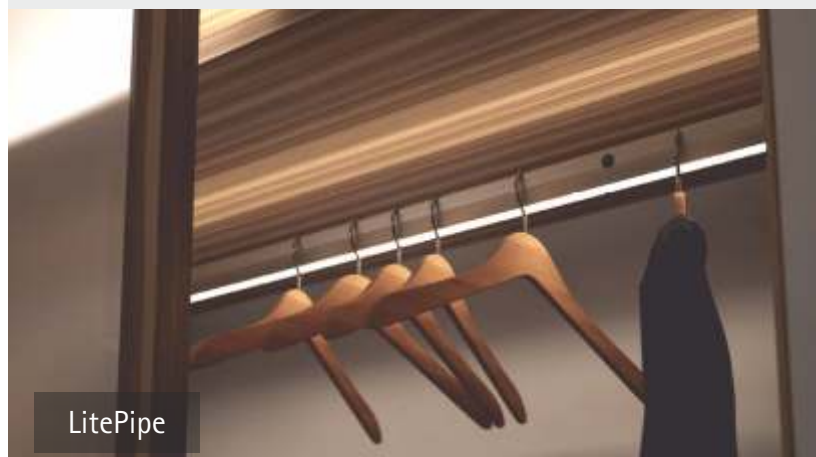
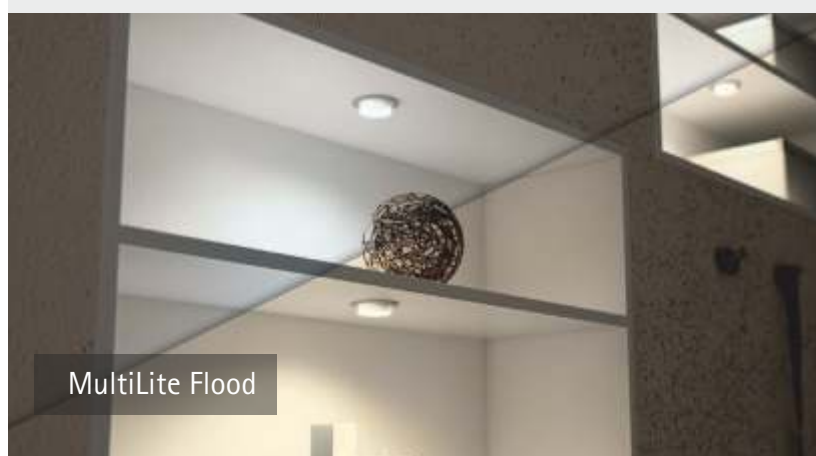

Material
Finish
Head
Drive
Thread
Packing

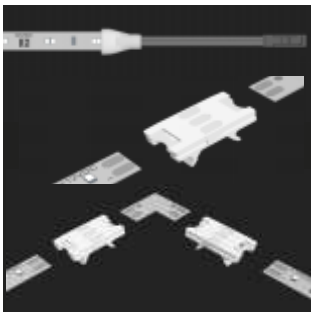











Steel
Zinc Coated
Pan head
Cross recessed
M4
Retail

S.no.	Description Et Dimension	Qty.	Article No.	SAP	Unit	PU	MRP	HS Code
1	Handle Fixing Screw M4 x 22	100	71549	71549	Pc	1000	143	73181200
2	Handle Fixing Screw M4 x 24	100	71555	71555	Pc	1000	143	73181200
3	Handle Fixing Screw M4 x 26	100	71556	71556	Pc	1000	154	73181200
4	Handle Fixing Screw M4 x 28	100	71557	71557	Pc	500	165	73181200
5	Handle Fixing Screw M4 x 30	100	71558	71558	Pc	500	165	73181200
6	Handle Fixing Screw M4 x 32	100	71559	71559	Pc	500	175	73181200
7	Handle Fixing Screw M4 x 36	100	71561	71561	Pc	500	198	73181200
8	Handle Fixing Screw M4 x 38	100	71562	71562	Pc	500	209	73181200
9	Handle Fixing Screw M4 x 40	100	71563	71563	Pc	200	220	73181200
10	Handle Fixing Screw M4 x 50	100	9184222	9184222	Pc	200	252	73181200

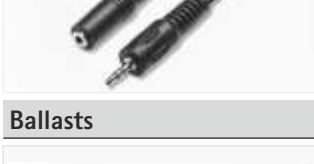

Product	Article No.	SAP	Item Description	Qty.	Unit	PU	MRP	HS Code
Lights								
	Linear Light							
	5580113	9243905	LED Versa Inside 60,12VDC, WW, L=5m, 4.8W/m LTG 1.8m, M1	1	Pc	1	5,259	94054039
	5580513	9243901	LED Versa Inside 90,12VDC, WW, L=5m, 7.2W/m LTG 1.8m, M1	1	Pc	1	6,843	94054039
	Linear Light Accessories							
	3633002	9243892	Feeder 1700 mm for sections (max. 36 W), 12 V DC	1	Pc	1	283	85444290
	3633401	9254412	Direct Connector (max. 36 W)[Strip to strip connector]	1	Pc	1	182	85366990
	3633501	9258311	Direct Connector 90° (max. 36W)	1	Pc	1	173	94059200
	3633601	9283535	Flexible connector 150 mm (max. 36 W)	1	Set	1	276	94059200
Profiles								
	ChannelLine B							
	5566002	9162612	ChannelLine B, Opal Cover, Aluminium / plastic profile 3000 mm, Depth = 13.5 mm	1	Pc	1	4,563	94054039
	2556801	9244247	End Cap	1	Set	1	143	94059900
	2553601	9244278	Spring Channel line B/C	1	Pc	2	126	94059900
	ChannelLine F							
	5566402	9162630	ChannelLine F, Opal Cover, Plastic profile 3000 mm, Depth =8mm	1	Pc	1	3,063	94054039
	ChannelLine H (Corner Profile)							
	5570602	9244566	ChannelLine H, Opal Cover, Aluminium / plastic profile 3000 mm, Depth =11mm	1	Pc	1	3,790	94054039
	2555901	9244567	End cap (Set of 2)	1	Set	1	105	94059200
	ChannelLine G2							
	5570502	9244282	ChannelLine G2, Aluminium / plastic profile 3000 mm, Opal cover, Depth = 9.6mm	1	Pc	1	4,706	94059900
	2555601	9244283	End cap (2 units per set, left + right)	1	Set	1	129	94059200
	ChannelLine C Recessed Profile							
	5566102	9162617	ChannelLine C, Aluminium / plastic profile 3000 mm, Opal cover, Depth = 7.5mm	1	Pc	1	4,524	94054039
	2556901	9242650	End cap (2 units per set)	1	Set	1	143	94059200
	ChannelLine D, Recessed and Surface Mounted Profile							
	5566202	9162620	ChannelLine Versa D - L=3000mm, opal cover, Depth = 10mm	1	Pc	1	4,657	94054039
	2557001	9244279	End cap (2 units per set)	1	Set	1	143	94059200

Product	Article No.	SAP	Item Description	Qty.	Unit	PU	MRP	HS Code
Spot Light and special Light								
	Powerlite Plus							
	3206319	9246819	PowerLite Plus round stainless steel look,12 V DC, WW, 3.5 W	1	Pc	1	2,066	94054039
	3699709	9116011	Surface mounted housing	1	Pc	1	287	94054090
	MultiLite Flood							
	3215011	9245068	MultiLite Flood, Al look, WW, 12V DC (Light without outer ring)	1	Pc	1	2,415	94054039
	2517526	9245072	Cover Ring- Aluminum look	1	Pc	1	280	94059200
	2517516	9245073	Cover Ring- Chrome, Matte	1	Pc	1	280	94059200
	2517509	9245077	Cover Ring- Stainless Steel finish	1	Pc	1	413	94059200
	2517504	9254413	Cover Ring- Gold finish	1	Pc	1	329	94059200
2517502	9254414	Cover Ring- Bronze	1	Pc	1	280	94059200	
	Eco Spot							
	3215316	9245101	Eco spot aluminium finish	1	Pc	1	916	94054099
	3624406	9245114	Surface mounted housing aluminium finish	1	Pc	1	262	94054090
	EcoPower L							
	3623606	9245119	Surface mounting housing in aluminium finish	1	Pc	1	331	94054090
	3214416	9245088	LED Eco Power L Aluminium Look warm white	1	Pc	1	1,510	94054039
	Power Square Long (Used below wall unit)							
	3461717	9162644	600 mm,12VDC, Al, WW, 3.6W	1	Pc	1	7,416	94054090
	3461817	9162646	900 mm,12VDC, Al, WW, 5.4W	1	Pc	1	10,650	94054090
	3461917	9162648	1200 mm,12VDC, Al, WW, 7.2W	1	Pc	1	13,881	94054090
Special Light								
	GlasLine (Back glass profile), Set							
	5580112	9243903	Versa Inside 60, 1.2 m strip in WW, L=1200mm,	1	Pc	1	1,566	94054039
	1872001	9162721	12VDC, 5W U-profile for flexible strip 14 x 11.2 x 3000 mm	1	Pc	1	4,252	94059900
	1849110	9258327	spacer for glass plate	1	Pc	1	601	94059200
	3414901	9162759	Ice, Warm white, 0.9W	1	Pc	1	2,331	94054090
	Battery operated Light							
	3825826	9242651	LED lucky LITE cool-white sensor aluminium finish	1	Pc	1	3,101	83021090
	3002601	9162804	Mini USB charger	1	Pc	1	888	85043180
	Drawer Light with integrated IR sensor							
	5516803	9162747	LED Innoline Plus NW 12V DC L=401-600 mm, 6W	1	Pc	1	4,507	94054090
	5516804	9162748	LED Innoline Plus NW 12V DC L=501-600 mm, 3 W	1	Pc	1	4,969	94054090
	5516807	9162751	LED Innoline Plus NW 12V DC L=801-900 mm, 4.5 W	1	Pc	1	5,916	94054090
	5516808	9162752	LED Innoline Plus NW 12V DC L=901-1000 mm, 5 W	1	Pc	1	6,273	94054090
	5516810	9162754	LED Innoline Plus NW 12V DC L=1101-1200 mm, 6W	1	Pc	1	7,063	94054090
	Wardrobe Light with inbuilt motion sensor							
	9150406	9150406	LED Lite Pipe 12V 1000 mm WW, 5W	1	Pc	1	9,955	94054090
	9150407	9150407	LED Lite Pipe 12V 1200 mm WW, 5W	1	Pc	1	10,787	94054090
	9150408	9150408	LED Lite Pipe 12V 1000 mm CW, 5.5W	1	Pc	1	9,955	94054090
	9150409	9150409	LED Lite Pipe 12V 1200 mm CW, 5.5W	1	Pc	1	10,787	94054090
	9162787	9162787	LED - Transformer 12VDC 6W HIN	1	Pc	1	1,518	85365080



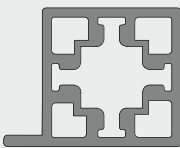

Product	Article No.	SAP	Item Description	Qty.	Unit	PU	MRP	HS Code
Sensor								
	IR Sensor (Surface mounting)							
	3076401	9152784	Master unit 12 V DC	1	Pc	1	1,769	85365007
	3064201	9152785	IR-Sensor for surface mounting	1	Pc	1	1,158	85365007
	IR Sensor (Drill Hole mounting)							
	3076401	9152784	Master unit 12 V DC	1	Pc	1	1,769	85365007
	3076751	9245711	IR Sensor for Drill hole mounting	1	Pc	1	791	85365005
	IR Sensor - Without Master Unit							
	3103301	9267112	IR Door Contact switch standalone (it doesn't required master unit)	1	Pc	1	2,208	85365005
	Motion Sensor							
	3076401	9152784	Master unit 12 V DC	1	Pc	1	1,769	85365007
	3063801	9152786	IR Sensor for Drill hole mounting	1	Pc	1	1,895	85365007
	Motion Sensor without Master Unit							
	3078401	9267111	Motion -Sensor (standalone)	1	Pc	1	2,242	85365005
	Master unit 12 V DC							
	3076401	9152784	Master unit 12 V DC	1	Pc	1	1,769	85365007
	Extension Wire For Sensor							
	1823803	9259373	Extension lead sensor cable - 2.5 mm jack - 2000 mm	1	Pc	1	490	85444290
Ballasts								
	3022602	9162787	LED-Ballast 12V DC 6W with flat euro plug	1	Pc	1	1,518	85365080
	3101601	9244918	LED-Ballast 12V DC 20 W with flat Euro plug and 6- way distributor	1	Pc	1	2,335	85044082
	3100207	9248604	LED-Ballast 12V DC 30 W with flat Euro plug and 6- way distributor	1	Pc	1	3,757	85365080
	3011501	9162792	LED ballast (wide voltage) 30 W with flat Euro plug	1	Pc	1	5,179	85365080
	3099801	9162794	LED-Ballast 12V DC 50 W with flat Euro plug and 6- way distributor	1	Pc	1	4,890	85365080
Accessories								
	3685201	9244295	LED 3 way Distributer M1, 12V DC	1	Pc	1	367	85444290
	3612501	9084272	LED 6 way Distributer=M1 2m, 12V DC	1	Pc	1	589	85444290
	3676801	9104773	LED Extension M1, 12 V DC	1	Pc	1	286	85444290
	3623801	9244294	Cable Duct, self-adhesive, 1000mm, white	1	Pc	1	528	94059200

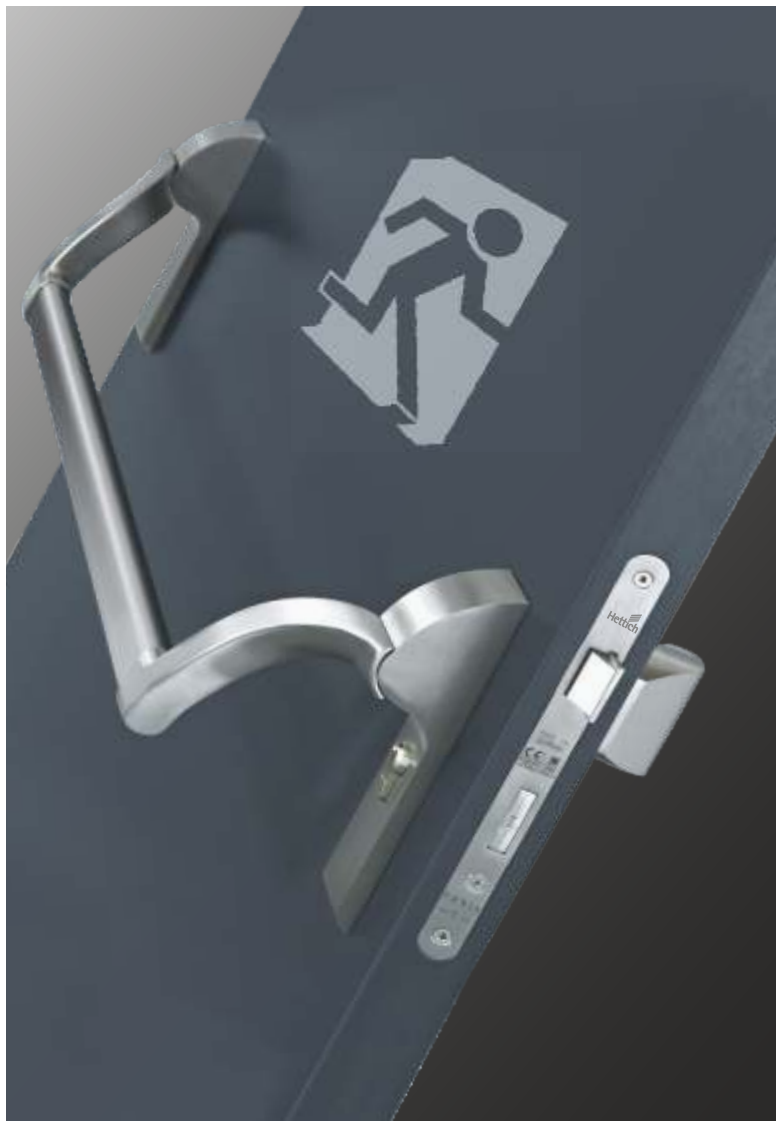

Product	Article No.	SAP	Item Description	Finish	Qty.	Unit	PU	MRP	HS Code
Basic Profiles									
	9282553	9282553	Basic profile (3000 mm length)	Matt Black	1	Pc	4	2,841	76042100
	9282555	9282555		Matt Nickel	1	Pc	4	2,841	76042100
	9282556	9282556	Profile for shelf panels for 16 mm panels (3000 mm length)	Matt Black	1	Pc	4	2,841	76042100
	9282557	9282557		Matt Nickel	1	Pc	4	2,841	76042100
	9282558	9282558	Profile for glass panels for 6 mm glass panels (3000 mm length)	Matt Black	1	Pc	4	2,841	76042100
	9282560	9282560		Matt Nickel	1	Pc	4	2,841	76042100
	9282561	9282561	Profile for side/shelf panels for 16 mm profiles, screw-connected (3000 mm length)	Matt Black	1	Pc	4	2,841	76042100
	9282562	9282562		Matt Nickel	1	Pc	4	2,841	76042100
Sliding Profile (Compatible with Slideline M)									
	9282563	9282563	Profile for sliding doors – External mounting, top (3000 mm length) Overlay door Position	Matt Black	1	Pc	4	3,127	76042100
	9282564	9282564	Profile for sliding doors – External mounting, bottom (3000 mm length) Overlay door Position	Matt Black	1	Pc	4	3,127	76042100
	9282565	9282565	Profile for sliding doors – Internal mounting, top (3000 mm length) Inset door Position	Matt Black	1	Pc	4	3,127	76042100
	9282566	9282566	Profile for sliding doors – Internal mounting, bottom (3000 mm length) Inset door Position	Matt Black	1	Pc	4	3,127	76042100

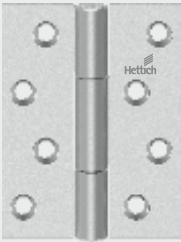





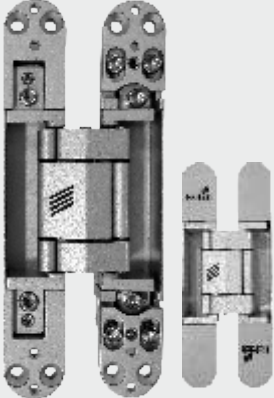

Product	Article No.	SAP	Item Description	Finish	Qty.	Unit	PU	MRP	HS Code
Profile Connector									
	9282567	9282567	Double Connector 2 Way	Matt Black	1	Pc	1	644	83024200
	9282577	9282577	Triple 2D Connector 3 Way	Matt Black	1	Pc	1	652	83024200
	9282576	9282576		Matt Nickel	1	Pc	1	652	83024200
	9282568	9282568	Triple 3D Connector 3 Way	Matt Black	1	Pc	1	652	83024200
	9282589	9282589		Matt Nickel	1	Pc	1	652	83024200
	9282590	9282590	Quadruple Connector 4 Way	Matt Black	1	Pc	1	721	83024200
	9282580	9282580		Matt Nickel	1	Pc	1	721	83024200
	9282579	9282579	Quintuple Connector 5 Way	Matt Black	1	Pc	1	819	83024200
	9282578	9282578		Matt Nickel	1	Pc	1	819	83024200
Fixing Material & Accessories									
	9282575	9282575	Fixing Screw M5 x 6mm	Matt Black	1	Pc	200	14	73181558
	9282574	9282574		Matt Nickel	1	Pc	200	14	73181558
	9282376	9282376	Cover Cap For M5 Screw	Matt Black	1	Pc	200	9	39263000
	9282573	9282573	Wall Mounting Set	-	1	Set	1	550	83024200
	9282571	9282571	Cover Cap (Black)	Matt Black	1	Set	1	26	39263000
	9282572	9282572	Fastening Sleeve (Fixing Set)	-	1	Set	1	226	73269098
	9282570	9282570	Height adjustment stand 20 mm (Height Adjustable Socket set)	-	1	Set	4	152	73269098
	9282569	9282569	Connecting Thread M8 (Socket Adapter set)	-	1	Set	4	152	39263000
	9282377	9282377	Ball Catches	-	1	Pc	4	149	73182900
	9282378	9282378	Self Adhesive Felt Pads (Set Contains 25 pads)	-	1	Set	1	1,879	56021019











Product	Article No.	SAP	Item Description	Qty.	Unit	PU	MRP	HS Code
	Mortise flush Door Hinge: HBN 20 Series							
	9228227	9228227	HBN-20 4141/160: 6.3x3.8x3.5, SS 304, Heavy duty hinge, Patented grease free ball bearing technology, Loading capacity 300kg/pair, EN1935 certified, Fire Rated; 200,000 cycles tested	01	Pair	01	7,319	83024110
	Mortise flush Door Hinge: HBN 14 Series							
	9228734	9228734	HBN-14 4x3x3 Square edge Z shape drilling pattern for timber doors, Capacity 160KG EN 1935 Grade14, Finish SS	1	Pair	1	1,485	83024110
	9228745	9228745	HBN-14 5x3x3 Square edge Z shape drilling pattern for timber doors, Capacity 160KG EN 1935 Grade14, Finish SS	1	Pair	1	1,593	83024110
	9228747	9228747	HBN-14 5x3x3 Round edge Z shape drilling pattern for timber doors, Capacity 160KG EN 1935 Grade14, Finish SS	1	Pair	1	1,593	83024110
	9250468	9250468	HBN-14 5x4x3 Square edge Z shape drilling pattern for timber doors, Capacity 160KG EN 1935 Grade14, Finish SS	1	Pair	1	1,740	83024110
	Spring Hinge							
	9228242	9228242	HBN-18-102/102-SPR: Spring Hinge, 4"x4"x3, SS 304, loading capacity 40kg/pair	01	Pair	01	1,901	83021090
	Lift off Hinge							
	9228245	9228245	HBN-13-4353C/102 SS L: Lift Off Hinge, 4"x3.5"x3, loading capacity 40kg/pair, DIN left	01	Pair	01	1,156	83021090
	Rising Hinge							
	9228720	9228720	HBN-13-102/76-RSN DIN Right: Rising Hinge, 4"x3"x3, loading capacity 26kg/pair, DIN Right	01	Pair	01	1,026	83021090
	Flush Hinge							
	9228247	9228247	HBN- 13-4325ZM/102: Flush Hinge, 4"x3"x2.5 mm loading capacity 40kg/pair	01	Pair	01	816	83021090









Product	Article No.	SAP	Item Description	Qty.	Unit	PU	MRP	HS Code
	Concealed Hinges (Hinge Material: Base: Zinc Alloy; Connector: SS 304)							
	9228248	9228248	HBC-25-1835/117: Concealed Hinge for min door thickness: 29 mm, loading capacity: 50 kg/pair	1	Pair	1	3,833	83021090
	9228249	9228249	HBC-28-2245/117: Concealed Hinge for min door thickness: 35 mm, loading capacity: 50 kg/pair	1	Pair	1	6,117	83021090
	3D Concealed Hinges (Hinge Material: Base: Zinc Alloy; Connector: Aluminum Alloy)							
	9228474	9228474	HBC-25-1440/150Z-3D: 3D-Concealed Hinge, Min Door Thickness: 35 mm, Loading Capacity: 40 kg/pair, Finish Silver	1	Pair	1	3,447	83021090
	9228475	9228475	HBC-28-1640/150Z-3D: 3D-Concealed Hinge, Min Door Thickness: 40 mm, Loading Capacity: 80 kg/pair, Finish Silver	1	Pair	1	4,589	83021090
	9228476	9228476	HBC-34-1845/246Z-3D: 3D-Concealed Hinge, Min Door Thickness: 45 mm, Loading Capacity: 120 kg/pair, Finish Silver	1	Pair	1	7,571	83021090







Product	Article No.	SAP	Item Description	Qty.	Unit	PU	MRP	HS Code
Surface Mounted Door Closer with Slide rail								
 	HSS 61							
	9227802	9227802	HSS 61 B: EN 5-6, For Door Width 1250-1400 mm and Door Weight 100-250 kg; Adjustable Back-check; EN1154 certified, Fire Rated; 500,000 cycles tested. (For hinge side mounting only)	1	Set	1	20,707	83024110
 	HSS 41							
	9227808	9227808	HSS 41: EN 1-4, With slide rail B; For Door Width 750-1100 mm and Door Weight 20-120 kg; Fixed Back-check; EN1154 certified, Fire Rated; 500,000 cycles tested.	1	Set	1	14,053	83024110
 	HSS 31							
	9227810	9227810	HSS 31: EN 1-3, With slide rail B; For Door Width 750-950 mm and Door Weight 20-100 kg; Fixed Back-check; EN1154 certified, Fire Rated; 500,000 cycles tested.	1	Set	1	11,426	83024110
 	HSS 33							
	9227812	9227812	HSS 33: EN 3, With slide rail K; For Door Width 750-950 mm and Door Weight 20-80 kg; EN1154 certified, Fire Rated; 500,000 cycles tested. (Cannot be made hold open door closer)	1	Set	1	8,284	83024110





















Product	Article No.	SAP	Item Description	Qty.	Unit	PU	MRP	HS Code
Surface Mounted Door Closer with Standard Arm								
 	HSA 20							
	9227814	9227814	HSA 20: EN 2/3/5, For Door Width 850-1250 mm and Door Weight 20-150 kg; Fixed Back-check; EN1154 certified, Fire Rated; 500,000 cycles tested.	1	Set	1	7,343	83024110
	HSA 15							
	9227815	9227815	HSA 15: EN 2/3/4/5, For Door Width 850-1250 mm and Door Weight 40-100 kg.	1	Set	1	6,498	83024110
	HSA 14							
	9228418	9228418	HSA 14: EN 1/2/3/4, For Door Width 750-1100 mm and Door Weight 40-80 kg.	1	Set	1	4,935	83024110
 	HSA 10 D EN							
	9227817	9227817	HSA 10 D EN: EN 2/3/4, For Door Width 850-1100 mm and Door Weight 40-80 kg; with standard arm; EN 1154 Certified; Fire Rated.	1	Set	1	3,024	83024110
	9228767	9228767	HSA 10 D EN HO: EN 2/3/4, For Door Width 850-1100 mm and Door Weight 40-80 kg; With Hold Open Arm, EN 1154 Certified; Fire Rated.	1	Set	1	4,012	83024110
 	HSA 10 F							
	9227816	9227816	HSA 10 F: EN 2/3/4, For Door Width 850-1100 mm and Door Weight 40-80 kg; Fire Rated; with standard arm	1	Set	1	2,688	83024110
	9228766	9228766	HSA 10 F HO: EN 2/3/4, For Door Width 850-1100 mm and Door Weight 40-80 kg, with Hold Open Arm, Fire Rated	1	Set	1	3,371	83024110
	HSA 10							
	9227818	9227818	HSA 10: EN 2/3/4, For Door Width 850-1100 mm and Door Weight 40-80 kg, with standard arm;	1	Set	1	2,592	83024110
	9228765	9228765	HSA 10 HO: EN 2/3/4, For Door Width 850-1100 mm and Door Weight 40-80 kg, with Hold Open Arm	1	Set	1	2,988	83024110







Product	Article No.	SAP	Item Description	Qty.	Unit	PU	MRP	HS Code
	HSA 10 X							
	9250587	9250587	HSA 10 X: EN 3, For Door Width 750-1000 mm and Door Weight 20-60 kg, with standard arm	1	Set	1	1,735	83014000
Concealed Door Closer with hold open Slide rail								
	HCS Multi G							
	9227820	9227820	HCS Multi G only Body: EN 2-5, For Door Width 850-1250 mm and Door Weight 40-130 kg; EN1154 Certified; Fire rated; 500,000 cycle tested (Min. Door Thickness - 40 mm)	1	Set	1	37,520	83024110
	9227825	9227825	Slide rail for HCS Multi G 21x31, With hold open	1	Set	1	9,734	83024110
 	HCS 400							
	9250843	9250843	HCS 400 with hold open Slide rail: EN 2-4, For Door Width 850-1100 mm and Door Weight 40-120 kg; EN1154 Certified; Fire rated; 500,000 cycle tested (Min. Door Thickness - 40 mm)	1	Set	1	14,410	83024110
	HCS 385							
	9227823	9227823	HCS 385: EN 2-4, With Hold Open Slide rail; For Door Width 850-1100 mm and Door Weight 40-80 kg (Min. Door Thickness - 45 mm).	1	Set	1	7,895	83024110
	HCS 380							
	9227824	9227824	HCS 380: EN 3, With Hold Open Slide rail; For Door Width 950 mm and Door Weight 60 kg (Min. Door Thickness - 40 mm).	1	Set	1	5,952	83024110
Door Closer Accessories								
	Hold Open Arm							
	9227829	9227829	Hold Open Arm (70-130°) for all standard arm model	1	Set	1	1,769	83024110
	Hold open device							
	9227831	9227831	FKL Hold Open device for slide rail B for Models: HSS 61/51/41/31 (not to be used with HSS 33)	1	Set	1	962	83024110







Product	Article No.	SAP	Item Description	Qty.	Unit	PU	MRP	HS Code
Mortise Handles-ProLock 2 (Hollow) SS 304, Satin finish, EN 1906 certified; 200,000 cycles tested; 5 years Functional Warranty								
	Prolock 2 HH 110 as per EN 1906 (Hollow)							
	9228066	9228066	ProLock 2 HH 110 Handle + Handle set SS	1	Set	1	2,397	83024110
	Prolock 2 HH 310 as per EN 1906 (Hollow)							
	9228075	9228075	ProLock 2 HH 310 Handle + Handle set SS	1	Set	1	2,397	83024110
	Prolock 2 HH 410 as per EN 1906 (Hollow)							
	9228078	9228078	ProLock 2 HH 410 Handle + Handle set SS	1	Set	1	2,967	83024110
	Prolock 2 HH 510 as per EN 1906 (Hollow)							
	9228081	9228081	ProLock 2 HH 510 Handle + Handle set SS	1	Set	1	2,967	83024110











Product	Article No.	SAP	Item Description	Qty.	Unit	PU	MRP	HS Code
Mortise Handles-ProLock 1 SS 304, ; 200,000 cycles tested in-house lab.; 5 years Functional Warranty								
Prolock 1 HH 2110 (Hollow)								
	9228099	9228099	ProLock 1 HH 2110 Handle + Handle set SS	1	Set	1	1,334	83024110
	9249908	9249908	ProLock 1 HH 2110 Handle + Handle set AB	1	Set	1	1,639	83021090
	9249960	9249960	ProLock 1 HH 2110 Handle + Handle set CR	1	Set	1	1,639	83021090
	9250012	9250012	ProLock 1 HH 2110 Handle + Handle set BL	1	Set	1	1,744	83021090
	9250064	9250064	ProLock 1 HH 2110 Handle + Handle set PB	1	Set	1	1,639	83021090
Prolock 1 HH 2210 (Hollow)								
	9250321	9250321	ProLock 1 HH 2210 Handle + Handle set SS	1	Set	1	1,193	83024110
Prolock 1 HH 2310 (Hollow)								
	9228102	9228102	ProLock 1 HH 2310 Handle + Handle set SS	1	Set	1	1,334	83024110
	9228104	9228104	ProLock 1 HH 2310 Handle + WC Bathroom set SS (Please order only Bathroom Lock along with WC version set)	1	Set	1	1,934	83024110
	9249910	9249910	ProLock 1 HH 2310 Handle + Handle set AB	1	Set	1	1,639	83021090
SS: Stainless Steel		AB: Antique Brass		CR: Chrome		BL: Black		SB: Satin Brass





Product	Article No.	SAP	Item Description	Qty.	Unit	PU	MRP	HS Code
Prolock 1 HH 2340 (Hollow)								
	9228108	9228108	ProLock 1 HH 2340 Handle + Handle set SS	1	Set	1	1,307	83024110
	9249914	9249914	ProLock 1 HH 2340 Handle + Handle set AB	1	Set	1	1,639	83021090
Prolock 1 HH 2410 (Hollow)								
	9228111	9228111	ProLock 1 HH 2410 Handle + Handle set SS	1	Set	1	1,767	83024110
	9249916	9249916	ProLock 1 HH 2410 Handle + Handle set AB	1	Set	1	2,101	83021090
Prolock 1 HH 2510 (Hollow)								
	9251130	9251130	ProLock 1 HH 2510 Handle + Handle set SS	1	Set	1	1,284	83024110
Prolock 1 HH 2730 (Hollow)								
	9228114	9228114	ProLock 1 HH 2730 Handle + Handle set SS	1	Set	1	1,702	83024110
Prolock 1 HH 2610 (SS 304 Solid Die cast) (Suitable for door thickness of 40-66 mm)								
	9228768	9228768	ProLock 1 HH 2610 Handle + Handle set SS	1	Set	1	2,556	83024110
	9249923	9249923	ProLock 1 HH 2610 Handle + Handle set AB	1	Set	1	3,151	83021090
	9250079	9250079	ProLock 1 HH 2610 Handle + Handle set PB	1	Set	1	3,151	83021090
SS: Stainless Steel AB: Antique Brass CR: Chrome BL: Black SB: Satin Brass								

Product	Article No.	SAP	Item Description	Qty.	Unit	PU	MRP	HS Code	
	ProLock 1 HH 2620 (SS 304 Solid Die cast) (Suitable for door thickness of 40–66 mm)								
	9228770	9228770	ProLock 1 HH 2620 Handle + Handle set SS	1	Set	1	2,556	83024110	
	ProLock 1 HH 2630 (SS 304 Solid Die cast) (Suitable for door thickness of 40–66 mm)								
	9228772	9228772	ProLock 1 HH 2630 Handle + Handle set SS	1	Set	1	2,556	83024110	
	ProLock 1 HH 2640 (SS 304 Solid Die cast) (Suitable for door thickness of 40–66 mm)								
	9228774	9228774	ProLock 1 HH 2640 Handle + Handle set SS	1	Set	1	2,556	83024110	
	ProLock 1 HH 2650 (SS 304 Solid Die cast) (Suitable for door thickness of 40–66 mm)								
	9228776	9228776	ProLock 1 HH 2650 Handle + Handle set SS	1	Set	1	2,670	83024110	
	ProLock 1 HH 2660 (SS 304 Solid Die cast) (Suitable for door thickness of 40–66 mm)								
	9228778	9228778	ProLock 1 HH 2660 Handle + Handle set SS	1	Set	1	2,670	83024110	
 	ProLock 1 HH 2670 (SS 304 Solid Die cast) (Suitable for door thickness of 40–66 mm)								
	9228780	9228780	ProLock 1 HH 2670 Handle + Handle set SS	1	Set	1	2,670	83024110	
	9249987	9249987	ProLock 1 HH 2670 Handle + Handle set CR	1	Set	1	3,260	83021090	
SS: Stainless Steel		AB: Antique Brass		CR: Chrome		BL: Black		SB: Satin Brass	





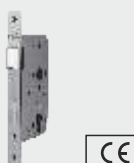

Product	Article No.	SAP	Item Description	Qty.	Unit	PU	MRP	HS Code
	ProLock 1 HH 2680 (SS 304 Solid Die cast) (Suitable for door thickness of 40-66 mm)							
	9228782	9228782	ProLock 1 HH 2680 Handle + Handle set SS	1	Set	1	2,556	83024110
	ProLock 1 HH 2690 (SS 304 Solid Die cast) (Suitable for door thickness of 40-66 mm)							
	9228784	9228784	ProLock 1 HH 2690 Handle + Handle set SS	1	Set	1	3,001	83024110
	ProLock 1 HH 2710 (SS 304 Solid Die cast) (Suitable for door thickness of 40-66 mm)							
	9228786	9228786	ProLock 1 HH 2710 Handle + Handle set SS	1	Set	1	2,556	83024110
	ProLock 1 HH 2720 (SS 304 Solid Die cast) (Suitable for door thickness of 40-66 mm)							
	9228788	9228788	ProLock 1 HH 2720 Handle + Handle set SS	1	Set	1	2,556	83024110
	ProLock 1 HH 2740 (Hollow) (Suitable for door thickness of 40-66 mm)							
	9228790	9228790	ProLock 1 HH 2740 Handle + Handle set SS	1	Set	1	1,658	83024110
	ProLock 1 HH 2750 (Hollow) (Suitable for door thickness of 40-66 mm)							
	9228792	9228792	ProLock 1 HH 2750 Handle + Handle set SS	1	Set	1	1,578	83024110
SS: Stainless Steel AB: Antique Brass CR: Chrome BL: Black SB: Satin Brass								





Product	Article No.	SAP	Item Description	Qty.	Unit	PU	MRP	HS Code
	ProLock 1 HH 2760 (Hollow) (Suitable for door thickness of 40-66 mm)							
	9228794	9228794	ProLock 1 HH 2760 Handle + Handle set SS	1	Set	1	1,644	83024110
	ProLock 1 HH 2770 (Hollow) (Suitable for door thickness of 40-66 mm)							
	9228796	9228796	ProLock 1 HH 2770 Handle + Handle set SS	1	Set	1	1,658	83024110
Mortise handle Prolock 1 SS 304; 200,000 cycles tested in-house lab.; 5 years Functional Warranty								
	ProLock 1 HH 2110 (Oval Rose Hollow Handles) (Suitable for door thickness of 40-66 mm)							
	9228117	9228117	ProLock 1 HH 2110/O Handle + Handle set SS	1	Set	1	1,431	83024110
	ProLock 1 HH 2310 (Oval Rose Hollow Handles) (Suitable for door thickness of 40-66 mm)							
	9228121	9228121	ProLock 1 HH 2310/O Handle + Handle set SS	1	Set	1	1,407	83024110
Spare Escutcheons								
	Round PZ Escutcheon (For Dead bolt / Roller Latch / Single Dead Bolt Lock Only)							
	9228459	9228459	Round PZ Escutcheon 1	1	Set	1	268	83014090
	Oval PZ Escutcheon							
	9250390	9250390	Oval PZ Escutcheon	1	Set	1	256	83014090
	Round WC Escutcheon (For single bathroom lock only)							
	9228706	9228706	Round WC Escutcheon 1	1	Set	1	813	83014090
	Round WC Escutcheon 2							
	9227805	9227805	Round WC Escutcheon 2	1	Set	1	779	83014090
SS: Stainless Steel AB: Antique Brass CR: Chrome BL: Black SB: Satin Brass								



Product	Article No.	SAP	Item Description	Qty.	Unit	PU	MRP	HS Code
Lock Body (72 mm Centre to Centre Distance)								
	Sash Locks (For Main and Internal doors)							
	9228136	9228136	HBS 31 FSL: Sash Lock DIN Left/Right CTC 72 & Backset 55 SS Finish	1	Set	1	1,482	83014090
	9228137	9228137	HBS 31 FSL: Sash Lock DIN Left/Right CTC 72 & Backset 60 SS Finish	1	Set	1	1,482	83014090
	9250117	9250117	HBS 31 FSL: Sash Lock DIN Left/Right CTC 72 & Backset 55 AB Finish	1	Set	1	1,664	83014090
	Dead Bolt Lock (Without Mortise handle)							
	9228140	9228140	HBS 31 FDL: Dead Lock DIN Left/Right CTC 72 & Backset 55 SS Finish	1	Set	1	1,336	83014090
	9228459	9228459	Round PZ Escutcheon 1 SS Finish	1	Set	1	268	83014090
	9250144	9250144	HBS 31 FDL: Dead Lock DIN Left/Right CTC 85 & Backset 60 - AB Finish (Please Order Escutcheon separately)	1	Set	1	1,428	83014090
	Bathroom Lock (For use in bathroom doors with WC version handles)							
	9228142	9228142	HBS 31 FBL: Bathroom Lock DIN Left/Right CTC 78 & Backset 55 SS Finish	1	Set	1	1,598	83014090
	9228143	9228143	HBS 31 FBL: Bathroom Lock DIN Left/Right CTC 78 & Backset 60 SS Finish (Only to be used with WC version handles)	1	Set	1	1,598	83014090
	Roller latch (For two way opening doors)							
	9228147	9228147	HBS 31 FRL: Roller Latch Lock DIN Left/Right CTC 72 & Backset 60	1	Set	1	1,893	83014090
	9228459	9228459	Round PZ Escutcheon 1 (Please order Escutcheon Separately)	1	Set	1	268	83014090
SS: Stainless Steel AB: Antique Brass PSS: Polished Stainless Steel BL: Black SB: Satin Brass								

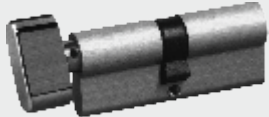

Product	Article No.	SAP	Item Description	Qty.	Unit	PU	MRP	HS Code
Lock Body (85/92 mm Centre to Centre Distance)								
	Sash Lock (For Main and Internal doors)							
	9228576	9228576	HBS 31 FSL: Sash Lock DIN Left/Right CTC 85 Et Backset 45 SS Finish	1	Set	1	1,365	83014090
	9228577	9228577	HBS 31 FSL: Sash Lock DIN Left/Right CTC 85 Et Backset 50 SS Finish	1	Set	1	1,386	83014090
	9228578	9228578	HBS 31 FSL: Sash Lock DIN Left/Right CTC 85 Et Backset 55 SS Finish	1	Set	1	1,386	83014090
	9228579	9228579	HBS 31 FSL: Sash Lock DIN Left/Right CTC 85 Et Backset 60 SS Finish	1	Set	1	1,436	83014090
	9250129	9250129	HBS 31 FSL: Sash Lock DIN Left/Right CTC 85 Et Backset 45 - AB Finish	1	Set	1	1,507	83021090
	9250130	9250130	HBS 31 FSL: Sash Lock DIN Left/Right CTC 85 Et Backset 50 - AB Finish	1	Set	1	1,460	83021090
	9250131	9250131	HBS 31 FSL: Sash Lock DIN Left/Right CTC 85 Et Backset 55 - AB Finish	1	Set	1	1,460	83021090
	9250132	9250132	HBS 31 FSL: Sash Lock DIN Left/Right CTC 85 Et Backset 60 - AB Finish	1	Set	1	1,616	83021090
	9250175	9250175	HBS 31 FSL: Sash Lock DIN Left/Right CTC 85 Et Backset 45 - PSS Finish	1	Set	1	1,569	83021090
	9250178	9250178	HBS 31 FSL: Sash Lock DIN Left/Right CTC 85 Et Backset 60 - PSS Finish	1	Set	1	1,681	83021090
	9250220	9250220	HBS 31 FSL: Sash Lock DIN Left/Right CTC 85 Et Backset 35 - BL Finish	1	Set	1	1,633	83021090
	9250267	9250267	HBS 31 FSL: Sash Lock DIN Left/Right CTC 85 Et Backset 45 - SG Finish	1	Set	1	1,507	83021090
	9250270	9250270	HBS 31 FSL: Sash Lock DIN Left/Right CTC 85 Et Backset 60 - SG Finish	1	Set	1	1,616	83021090
Lock Body EN 12209 Series (72 mm CTC locks) SS 304: Latch and Dead Bolt; 200,000 cycles tested ; 5 years Functional Warranty								
	Sash Lock (For Fire Rated Main and Internal doors)							
	9251082	9251082	HBS 31 FESL: Sash Lock DIN Left/Right CTC 72 Et Backset 60 EN 12209, Fire Rated	1	Set	1	1,400	83014090
SS: Stainless Steel		AB: Antique Brass		PSS: Polished Stainless Steel		BL: Black		SB: Satin Brass

Product	Article No.	SAP	Item Description	Qty.	Unit	PU	MRP	HS Code
Special locks								
	Security Lock							
	9250585	9250585	HBS 31 SL: Security Lock DIN Left/Right CTC 85 Et Backset 60	1	Set	1	1,508	83014090
	Single Dead Bolt Lock							
	9228148	9228148	HBS 31 FSDL: Single Dead Lock DIN Left/Right Backset 55	1	Set	1	1,137	83014090
	9228459	9228459	Round PZ Escutcheon 1 (Please Order Escutcheon separately)	1	Set	1	268	83014090
	Single Latch Lock							
	9228149	9228149	HBS 31 FSSL: Single Latch Lock DIN Left/Right Backset 55	1	Set	1	1,172	83014090
	Roller Catch Lock							
	9228716	9228716	Roller ball Catch	1	Set	1	1,087	83014090
	Allen key Tubewell Lock							
	9250584	9250584	Allen key Tubewell Lock SS	1	Set	1	732	83014090

Product	Article No.	SAP	Item Description	Qty.	Unit	PU	MRP	HS Code
Wooden Sliding Locks and Handles / Escutcheons								
	Sliding PZ Lock							
	9228481	9228481	Hettich Sliding Lock PZ DIN Left/Right backset 50 mm (Please order Sliding Handle or Escutcheon Et also order Euro Profile cylinder as per door thickness)	1	Set	1	987	83014090
	Sliding Handles with PZ hole							
	9228483	9228483	Hettich Sliding Handles For Timber Doors of Thickness 40-50 mm SS 304 Satin Finish (Please order Euro Profile cylinder as per door thickness)	1	Set	1	1,231	83014090
	Sliding door Escutcheons with PZ hole							
	9228484	9228484	Sliding Door Escutcheons For Timber Doors SS304 Satin Finish (Please order Euro Profile cylinder as per door thickness)	1	Set	1	1,231	83014090
	Sliding WC Lock							
	9228482	9228482	Hettich Sliding Lock WC DIN Left/Right backset 50 mm (Please order WC Sliding Handle or Escutcheon)	1	Set	1	987	83014090
	Sliding Door WC handle with knob							
	9228712	9228712	WC Sliding Door Handle For Timber Doors SS 304 Satin Finish	1	Set	1	1,264	83014090
	Sliding WC Escutcheon with knob							
	9228713	9228713	WC Sliding Door Escutcheons For Timber Doors SS304 Satin Finish	1	Set	1	1,207	83014090

Product	Article No.	SAP	Item Description	Qty.	Unit	PU	MRP	HS Code
Euro profile cylinder								
	HSCL - Standard Double Cylinder							
	9228171	9228171	HSCL 60: Both side key 60 mm, for max door thickness - 40 mm - SS Finish	1	Set	1	1,204	83014090
	9228172	9228172	HSCL 70: Both side key 70 mm, for max door thickness - 50 mm - SS Finish	1	Set	1	1,267	83014090
	9228174	9228174	HSCL 80: Both side key 80 mm, for max door thickness - 60 mm - SS Finish	1	Set	1	1,368	83014090
	9250146	9250146	HSCL 60: Both side key 60 mm, for max door thickness - 40 mm - AB Finish	1	Set	1	1,267	83021090
	9250147	9250147	HSCL 70: Both side key 70 mm, for max door thickness - 50 mm - AB Finish	1	Set	1	1,331	83021090
9250149	9250149	HSCL 80: Both side key 80 mm, for max door thickness - 60 mm - AB Finish	1	Set	1	1,426	83021090	
	HTCL - Thumb Turn Cylinder							
	9228176	9228176	HTCL 60: One side key and one side knob 60 mm, for max door thickness - 40 mm - SS Finish	1	Set	1	1,333	83014090
	9228177	9228177	HTCL 70: One side key and one side knob 70 mm, for max door thickness - 50 mm - SS Finish	1	Set	1	1,402	83014090
	9228178	9228178	HTCL 75: One side key and one side knob 75 mm, for max door thickness - 55 mm - SS Finish	1	Set	1	1,453	83014090
	9228179	9228179	HTCL 80: One side key and one side knob 80 mm, for max door thickness - 60 mm - SS Finish	1	Set	1	1,500	83014090
	9228180	9228180	HTCL 90: One side key and one side knob 90 mm, for max door thickness - 70 mm - SS Finish	1	Set	1	1,598	83014090
9250324	9250324	HTCL 100: One side key and one side knob 100 mm, for max door thickness - 80 mm SS	1	Set	1	1,773	83014090	
	9250151	9250151	HTCL 60: One side key and one side knob 60 mm, for max door thickness - 40 mm - AB Finish	1	Set	1	1,394	83021090
	9250152	9250152	HTCL 70: One side key and one side knob 70 mm, for max door thickness - 50 mm - AB Finish	1	Set	1	1,461	83021090
	9250153	9250153	HTCL 75: One side key and one side knob 75 mm, for max door thickness - 55 mm - AB Finish	1	Set	1	1,508	83021090
	9250154	9250154	HTCL 80: One side key and one side knob 80 mm, for max door thickness - 60 mm - AB Finish	1	Set	1	1,604	83021090
	9250197	9250197	HTCL 60: One side key and one side knob 60 mm, for max door thickness - 40 mm - PSS Finish	1	Set	1	1,461	83021090
	9250198	9250198	HTCL 70: One side key and one side knob 70 mm, for max door thickness - 50 mm - PSS Finish	1	Set	1	1,524	83021090
	9250199	9250199	HTCL 75: One side key and one side knob 75 mm, for max door thickness - 55 mm - PSS Finish	1	Set	1	1,572	83021090
	9250200	9250200	HTCL 80: One side key and one side knob 80 mm, for max door thickness - 60 mm - PSS Finish	1	Set	1	1,667	83021090
	9250243	9250243	HTCL 60: One side key and one side knob 60 mm, for max door thickness - 40 mm - BL Finish	1	Set	1	1,975	83021090
	9250244	9250244	HTCL 70: One side key and one side knob 70 mm, for max door thickness - 50 mm - BL Finish	1	Set	1	2,041	83021090
	9250245	9250245	HTCL 75: One side key and one side knob 75 mm, for max door thickness - 55 mm - BL Finish	1	Set	1	2,094	83021090
	9250246	9250246	HTCL 80: One side key and one side knob 80 mm, for max door thickness - 60 mm - BL Finish	1	Set	1	2,139	83021090
SS: Stainless Steel		AB: Antique Brass		PSS: Polished Stainless Steel		BL: Black		SB: Satin Brass

Product	Article No.	SAP	Item Description	Qty.	Unit	PU	MRP	HS Code
	9250289	9250289	HTCL 60: One side key and one side knob 60 mm, for max door thickness - 40 mm - SG Finish	1	Set	1	1,270	83021090
	9250290	9250290	HTCL 70: One side key and one side knob 70 mm, for max door thickness - 50 mm - SG Finish	1	Set	1	1,339	83021090
	9250291	9250291	HTCL 75: One side key and one side knob 75 mm, for max door thickness - 55 mm - SG Finish	1	Set	1	1,389	83021090
	9250292	9250292	HTCL 80: One side key and one side knob 80 mm, for max door thickness - 60 mm - SG Finish	1	Set	1	1,434	83021090
HBCL - Bathroom Cylinder								
	9228181	9228181	HBCL 60: One side knob and one side coin slot 60 mm, for max door thickness-40 mm - SS Finish	1	Set	1	968	83014090
	9228182	9228182	HBCL 70: One side knob and one side coin slot 70 mm, for max door thickness-50 mm- SS Finish	1	Set	1	1,051	83014090
	9228183	9228183	HBCL 75: One side knob and one side coin slot 75 mm, for max door thickness-55 mm- SS Finish	1	Set	1	1,110	83014090
	9250156	9250156	HBCL 60: One side knob and one side coin slot 60 mm, for max door thickness-40 mm - AB Finish	1	Set	1	1,004	83021090
	9250157	9250157	HBCL 70: One side knob and one side coin slot 70 mm, for max door thickness-50 mm - AB Finish	1	Set	1	1,091	83021090
	9250158	9250158	HBCL 75: One side knob and one side coin slot 75 mm, for max door thickness-55 mm - AB Finish	1	Set	1	1,164	83021090
	9250202	9250202	HBCL 60: One side knob and one side coin slot 60 mm, for max door thickness-40 mm - PSS Finish	1	Set	1	1,071	83021090
	9250203	9250203	HBCL 70: One side knob and one side coin slot 70 mm, for max door thickness-50 mm - PSS Finish	1	Set	1	1,159	83021090
	9250204	9250204	HBCL 75: One side knob and one side coin slot 75 mm, for max door thickness-55 mm - PSS Finish	1	Set	1	1,233	83021090
	9250248	9250248	HBCL 60: One side knob and one side coin slot 60 mm, for max door thickness-40 mm - BL Finish	1	Set	1	1,614	83021090
	9250249	9250249	HBCL 70: One side knob and one side coin slot 70 mm, for max door thickness-50 mm - BL Finish	1	Set	1	1,714	83021090
	9250250	9250250	HBCL 75: One side knob and one side coin slot 75 mm, for max door thickness-55 mm - BL Finish	1	Set	1	1,799	83021090
	9250294	9250294	HBCL 60: One side knob and one side coin slot 60 mm, for max door thickness-40 mm - SG Finish	1	Set	1	877	83021090
	9250295	9250295	HBCL 70: One side knob and one side coin slot 70 mm, for max door thickness-50 mm - SG Finish	1	Set	1	964	83021090
	9250296	9250296	HBCL 75: One side knob and one side coin slot 75 mm, for max door thickness-55 mm - SG Finish	1	Set	1	1,035	83021090
HHCL - Half Cylinder								
	9228184	9228184	HHCL 40: One side key only 40 mm, for max door thickness-40 mm - SS Finish	1	Set	1	1,137	83014090
	9228185	9228185	HHCL 45: One side key only 45 mm, for max door thickness-45 mm - SS Finish	1	Set	1	1,166	83014090
HHTL- Half Thumb Turn Cylinder								
	9228729	9228729	HHTL 40: One side thumb turn only 40 mm, for max door thickness-40 mm	1	Set	1	1,002	83014090
	9228730	9228730	HHTL 45: One side thumb turn only 45 mm, for max door thickness-45 mm	1	Set	1	1,036	83014090
SS: Stainless Steel		AB: Antique Brass		PSS: Polished Stainless Steel		BL: Black		SB: Satin Brass

Product	Article No.	SAP	Item Description	Qty.	Unit	PU	MRP	HS Code
Panic Bar Solution								
 	HPN 3000 RIM (Touch Bar Panic Device)							
	9228616	9228616	HPN 3000 RIM: 1 Point Locking, Touch bar, Steel Silver Painted, Fire Rated	1	Set	1	7,928	83014090
 	HPN 500 IN RIM (Push Bar Panic Device)							
	9228622	9228622	HPN 500 IN RIM: 1 Point Locking, Push bar, Steel Silver Painted, Fire Rated	1	Set	1	8,130	83014090
Panic Accessories for HPN 3000 and 500 IN								
	Counter Handle On Short Plate							
	9228704	9228704	Counter handle for HPN on Short Plate Silver	1	Set	1	7,012	83014090
	Counter Handle On Rose							
	9228705	9228705	Counter handle for HPN on Rose Silver	1	Set	1	4,395	83014090



ProLock Infinity : The Complete Main Door Solution



ProLock Infinity Lock System: Main Door locking solution having a combination of mortise and night latch lock system.

Technical detail in brief:

Handle:

- ▶ Movable handle both side
- ▶ Manual locking
- ▶ Cylinder Protection (anti drill protection for 10 pin cylinder)
- ▶ Returning Spring
- ▶ DIN Left/Right different model
- ▶ Door Thickness 35-50 mm
- ▶ Material: Stainless Steel 304

Lock Body:

- ▶ Centre to centre distance 68 mm
- ▶ Backset 60 mm
- ▶ Life time cycle: 200,000 cycles tested
- ▶ Material: Stainless Steel 304 (faceplate)

Euro Profile Cylinder:

- ▶ ProLock Infinity High security thumb turn 70 mm cylinder with computerized snake key way and anti drill pins
- ▶ Supplied with Five Main Keys & Two Construction Keys

Available finishes :

- ▶ Stainless Steel, Antique Brass, Champagne & Black

ProLock Infinity Lock System handles



Handle design 1



Handle design 2



Handle design 3



Handle design 4

Other Available finishes

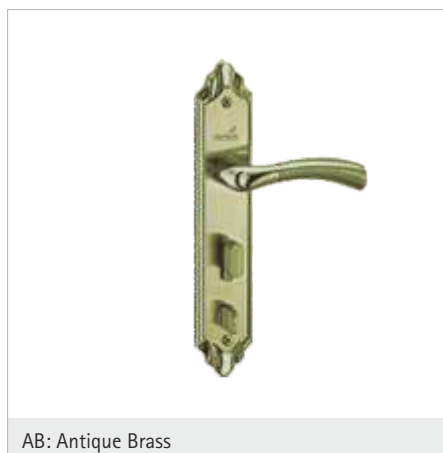

AB: Antique Brass

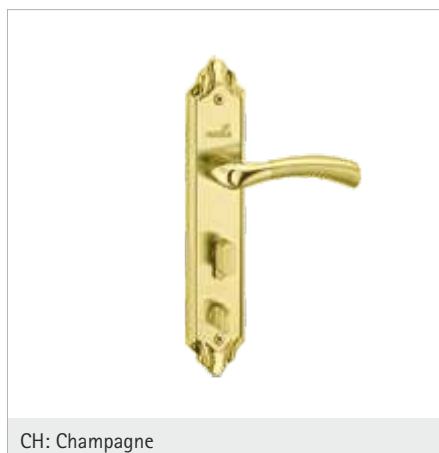



CH: Champagne



BL: Black



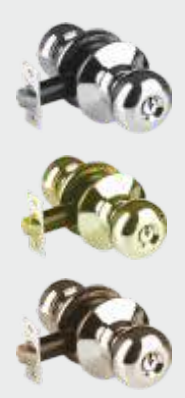

* Against Special Order





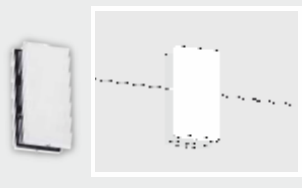

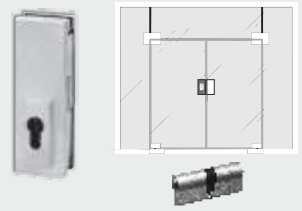
Product	Article No.	SAP	Item Description	Qty.	Unit	PU	MRP	HS Code
Prolock Infinity : The Complete Main Door Solution								
	Prolock Infinity Handles Design 1							
	9250858	9250858	ProLock Infinity 1 SS DIN Left- Movable	1	Set	1	4,606	83024110
	9250886	9250886	ProLock Infinity 1 SS DIN Right- Movable	1	Set	1	4,606	83024110
	9250859	9250859	ProLock Infinity 1 AB DIN Left- Movable	1	Set	1	6,837	83021090
	9250887	9250887	ProLock Infinity 1 AB DIN Right- Movable	1	Set	1	6,837	83021090
	Prolock Infinity Handles Design 2							
	9250890	9250890	ProLock Infinity 2 SS DIN Left- Movable	1	Set	1	4,606	83024110
	9250891	9250891	ProLock Infinity 2 SS DIN Right- Movable	1	Set	1	4,606	83024110
	9250860	9250860	ProLock Infinity 2 AB DIN Left- Movable	1	Set	1	6,837	83021090
	9250892	9250892	ProLock Infinity 2 AB DIN Right- Movable	1	Set	1	6,837	83021090
	Prolock Infinity Handles Design 3							
	9250863	9250863	ProLock Infinity 3 SS DIN Left- Movable	1	Set	1	4,606	83024110
	9250902	9250902	ProLock Infinity 3 SS DIN Right- Movable	1	Set	1	4,606	83024110
	9250864	9250864	ProLock Infinity 3 AB DIN Left- Movable	1	Set	1	6,837	83021090
	9250903	9250903	ProLock Infinity 3 AB DIN Right- Movable	1	Set	1	6,837	83021090
	Prolock Infinity Handles Design 4							
	9250867	9250867	ProLock Infinity 4 SS DIN Left- Movable	1	Set	1	4,606	83024110
	9250906	9250906	ProLock Infinity 4 SS DIN Right- Movable	1	Set	1	4,606	83024110
	9250868	9250868	ProLock Infinity 4 AB DIN Left- Movable	1	Set	1	6,837	83021090
	9250907	9250907	ProLock Infinity 4 AB DIN Right- Movable	1	Set	1	6,837	83021090
	Prolock Infinity Lock body with 5 point locking system							
	9228517	9228517	HBS 21 FSL: Sash Lock DIN Left/Right CTC 68 & Backset 60 with 3 Bolt, Latch And 1 Manual Bolt SS Finish	1	Set	1	2,195	83014090
	9228629	9228629	HBS 21 FSL: Sash Lock DIN Left/Right CTC 68 & Backset 60 with 3 Bolt, Latch And 1 Manual Bolt AB Finish	1	Set	1	2,545	83021090
	Prolock Infinity Cylinder with 5 Main keys & 2 construction keys							
	9228518	9228518	Prolock Infinity Euro Profile Cylinder with 2 Row Pin, Anti-Drill Pin & Reversible AB Key SS Finish	1	Set	1	2,420	83014090
	9228630	9228630	Prolock Infinity Euro Profile Cylinder with 2 Row Pin, Anti-Drill Pin & Reversible AB Key AB Finish	1	Set	1	3,311	83021090
SS: Stainless Steel AB: Antique Brass								









Product	Article No.	SAP	Item Description	Qty.	Unit	PU	MRP	HS Code
HCK 01 (Backset 60 mm & Door thickness 30 to 45 mm)								
	9228335	9228335	HCK 01 SS: One side Key and one side knob (For Room Doors), with 3 keys, dia. 65 mm	1	Set	1	901	83024110
	9228336	9228336	HCK 01 SS WC: One side Knob and other side emergency release slot, without key (for Washroom Doors), dia. 65 mm	1	Set	1	819	83024110
	9250827	9250827	HCK 01 SS BD: One side Knob and other side Dead Knob (for Balcony Doors), dia. 65 mm	1	Set	1	854	83024110
	9228337	9228337	HCK 01 PB: One side Key and one side Knob (For Room Doors) with 3 keys, dia. 65 mm	1	Set	1	1,214	83024110
	9228338	9228338	HCK 01 PB WC: One side Knob and other side emergency release slot, without key (for Washroom Doors), dia. 65 mm	1	Set	1	1,132	83024110
	9228339	9228339	HCK 01 AB: One side Key and one side Knob (For Room Doors), with 3 keys, dia. 65 mm	1	Set	1	1,214	83024110
	9228340	9228340	HCK 01 AB WC: One side Knob and other side emergency release slot, without key (for Washroom Doors), dia. 65 mm	1	Set	1	1,132	83024110
HCK 02 (Backset 60 mm & Door thickness 30 to 45 mm)								
	9228341	9228341	HCK 02 SS: One side Key and one side knob (For Room Doors), with 3 keys, dia. 75 mm	1	Set	1	1,036	83024110
	9228342	9228342	HCK 02 SS WC: One side Knob and other side emergency release slot, without key (for Bathroom Doors), dia. 75 mm	1	Set	1	952	83024110
	9228343	9228343	HCK 02 PB: One side Key and one side knob (For Room Doors), with 3 keys, dia. 75 mm	1	Set	1	1,588	83024110
	9228345	9228345	HCK 02 AB: One side Key and one side knob (For Room Doors), with 3 keys, dia. 75 mm	1	Set	1	1,620	83024110
	9228346	9228346	HCK 02 AB WC: One side Knob and other side emergency release slot, without key (for Bathroom Doors), dia. 75 mm	1	Set	1	1,538	83024110
HCH 01 (Adjustable Backset 60/70 mm & Door thickness 35 to 45 mm) : Internal / Residential use only								
	9228347	9228347	HCH 01 SS: One side Key and one side Knob (For Room Doors), with 3 keys, dia. 75 mm	1	Set	1	1,837	83024110
	9228348	9228348	HCH 01 SS WC: One side Knob and other side emergency release slot, without key (for Bathroom Doors), dia. 75 mm	1	Set	1	1,755	83024110
	9228350	9228350	HCH 01 PB WC: One side Knob and other side emergency release slot, without key (for Bathroom Doors), dia. 75 mm	1	Set	1	2,089	83024110
	9228351	9228351	HCH 01 AB: One side Key and one side Knob (For Room Doors), with 3 keys, dia. 75 mm	1	Set	1	2,171	83024110
	9228352	9228352	HCH 01 AB WC: One side Knob and other side emergency release slot, without key (for Bathroom Doors), dia. 75 mm	1	Set	1	2,089	83024110
HCH 02 (Adjustable Backset 60/70 mm & Door thickness 35 to 45 mm) : Internal / Residential use only								
	9228353	9228353	HCH 02 SS: One side Key and one side Knob (For Room Doors), with 3 keys, dia. 65 mm	1	Set	1	2,137	83024110
	9228354	9228354	HCH 02 SS WC: One side Knob and other side emergency release slot, without key (for Bathroom Doors), dia. 65 mm	1	Set	1	2,054	83024110
	9228357	9228357	HCH 02 AB: One side Key and one side Knob (For Room Doors), with 3 keys, dia. 65 mm	1	Set	1	2,471	83024110
	9228358	9228358	HCH 02 AB WC: One side Knob and other side emergency release slot, without key (for Bathroom Doors), dia. 65 mm	1	Set	1	2,388	83024110
SS: Stainless Steel			PB: Polished Brass			AB: Antique Brass		





Product	Article No.	SAP	Item Description	Qty.	Unit	PU	MRP	HS Code
Floor Spring								
	960 Series (Door Weight 300 kg)							
	9227859	9227859	HTS FS 960: For Door Width 950-1400 mm, Hold open at 90°, without accessories; EN1154 Certified; 500,000 cycle tested; Fire rated.	1	Set	1	36,717	83024110
	840 Series (Door Weight 150 Kg)							
	9227843	9227843	HTS FS 843: For Door Width 950 mm, No Hold open, without accessories; EN1154 Certified; 500,000 cycle tested; Fire rated.	1	Set	1	7,845	83024110
	9227844	9227844	HTS FS 843: For Door Width 950 mm, Hold open at 90°, without accessories; EN1154 Certified; 500,000 cycle tested; Fire rated.	1	Set	1	7,845	83024110
	9227847	9227847	HTS FS 844 (Body): For Door Width 1100 mm, Hold open at 90° without accessories; EN1154 Certified; 500,000 cycle tested; Fire rated.	1	Set	1	7,845	83024110
	650 Series (Door Weight 100 Kg)							
	9227850	9227850	HTS FS 652: For Door Width 850 mm, Hold open at 90°, without accessories; 200,000 cycle in-house lab tested.	1	Set	1	6,433	83024110
	9227853	9227853	HTS FS 653: For Door Width 950 mm, Hold open at 90°, without accessories; 200,000 cycle in-house lab tested.	1	Set	1	6,433	83024110
	9227856	9227856	HTS FS 654: For Door Width 1100 mm, Hold open at 90°, without accessories; 200,000 cycle in-house lab tested.	1	Set	1	6,433	83024110
	463 Series (Door Weight 80 Kg)							
	9228444	9228444	HTS FS 463: For Door Width 950 mm, Hold open at 90°, without accessories; 200,000 cycle in-house lab tested.	1	Set	1	4,637	83024110
	Floor Spring Accessories for Wooden and Steel Profile doors							
	9227863	9227863	Top Et Bottom Pivot for Wooden and Profile doors (For door weight up to 150 kg)	1	Set	1	1,339	83024110
	9228715	9228715	Heavy duty Top Et bottom pivot for floor pivot (For door weight up to 350 kg)	1	Set	1	4,060	83024110
	Floor pivot/ Hinge							
	9250826	9250826	Floor pivot/hinge with loading capacity of 150 Kg doors	1	Set	1	1,460	83024110

Product	Article No.	SAP	Item Description	Qty.	Unit	PU	MRP	HS Code
Hydraulic Glass Patch Fittings Sets (SS 304 satin finish cover; For 8–13 mm Glass thickness)								
	HBL- 30: Hydraulic Patch Set							
	9250568	9250568	HBL- 30: Hydraulic Bottom Patch for Max. door width 1000mm Et Max door weight 100 kg, Glass Thickness 8-13 mm	1	Set	1	11,540	83021090
	9250569	9250569	Top Patch for HBL-30	1	Set	1	2,455	83021090
Glass Patch Fittings (SS 304 satin finish cover; For 8–12 mm Glass thickness)								
	Bottom Patch							
	9228265	9228265	HGF 100 : Bottom Patch	1	Set	1	1,083	83024110
	Top Patch							
	9228266	9228266	HGF 200 : Top Patch	1	Set	1	1,083	83024110
	Overpanel Patch							
	9228267	9228267	HGF 300: Overpanel Patch	1	Set	1	1,066	83024110
	Overpanel side Patch							
	9228268	9228268	HGF 400 : Overpanel side Patch	1	Set	1	1,778	83024110
	Overpanel Patch with Fixing Plate							
	9228275	9228275	HGF 930 : Overpanel Patch with Fixing Plate	1	Set	1	1,112	83024110
	Wall to glass one panel							
	9228272	9228272	HGF 900: Wall to glass one panel	1	Set	1	1,033	83024110
	Wall to glass two panels							
	9228273	9228273	HGF 910: Wall to glass two panels	1	Set	1	1,299	83024110



Product	Article No.	SAP	Item Description	Qty.	Unit	PU	MRP	HS Code
Glass to Glass two panels Connector								
	9228274	9228274	HGF 920: Glass to glass two panels	1	Set	1	1,131	83024110
Connector for over panel								
	9228276	9228276	HGF 940: Connector for over panel	1	Set	1	1,516	83024110
Corner Patch lock								
	9228269	9228269	HGF 500 : Corner Patch lock	1	Set	1	1,754	83024110
	9228171	9228171	HSCL 60: Both side key 60 mm, for max door thickness - 40 mm	1	Set	1	1,204	83024110
Centre Patch lock								
	9228270	9228270	HGF 600 : Centre patch Lock	1	Set	1	2,215	83024110
	9228171	9228171	HSCL 60: Both side key 60 mm, for max door thickness - 40 mm (Please order Euro Profile cylinder 60 mm separately)	1	Set	1	1,204	83024110
Counter Lock for Centre Patch Lock								
	9228271	9228271	HGF 700 : Counter Lock for Centre Patch Lock	1	Set	1	988	83024110
Top pivot for Top patch								
	9228458	9228458	HGF 800: Fixed top pivot for top patch	1	Set	1	362	83024110
Glass Sliding (Partition)								
Glass Sliding Kit and Track for 8-12 mm Glass thickness								
	9228477	9228477	HR SL80-G: Glass Sliding for loading capacity 80 kg	1	Set	1	4,170	83024110
	9228478	9228478	HR SL80-G: Glass Sliding track length 3000 mm	1	Set	1	4,176	83024110

Product	Article No.	SAP	Item Description	Qty.	Unit	PU	MRP	HS Code
	HPH 2110 Back to Back Handles Dia: 19 mm							
	9228527	9228527	HPH 2110 : Back to Back Pull Handles Dia. 19mm, CTC Length 200mm, SS Finish	1	Set	1	1,336	83024110
	HPH 2110 Back to Back Handles Dia: 25 mm							
	9228529	9228529	HPH 2110 : Back to Back Pull Handles Dia. 25mm, CTC Length 300mm, SS Finish	1	Set	1	1,761	83024110
	9228531	9228531	HPH 2110 : Back to Back Pull Handles Dia. 25mm, CTC Length 400mm, SS Finish	1	Set	1	2,003	83024110
	HPH 2330 Back To Back Pull Handles Dia: 25 mm							
	9228547	9228547	HPH 2330: Back to Back Pull Handles Dia. 25 mm, CTC Length 200, SS Finish O/A 300	1	Set	1	1,700	83024110
	9228549	9228549	HPH 2330: Back to Back Pull Handles Dia. 25mm, CTC Length 300, SS Finish O/A 400	1	Set	1	1,884	83024110
	9228551	9228551	HPH 2330: Back to Back Pull Handles Dia. 25mm, CTC Length 400, SS Finish O/A 550	1	Set	1	2,307	83024110
	9228553	9228553	HPH 2330: Back to Back Pull Handles Dia. 25mm, CTC Length 900, SS Finish O/A 1200	1	Set	1	3,766	83024110
Connectors (Material: Brass with Chrome plating; For 8-10 mm Glass thickness) (96 hours salt spray tested)								
	HGC 01							
	9228297	9228297	HGC 01: 90° Wall to Glass / Floor to Glass Connector	1	Pc	1	612	83024110
	HGC 02							
	9228298	9228298	HGC 02: 90° Wall to Glass / Floor to Glass Connector	1	Pc	1	873	83024110
	HGC 03							
	9228299	9228299	HGC 03: 90° Glass to Glass Connector	1	Pc	1	1,242	83024110
	HGC 04							
	9228300	9228300	HGC 04: 180° Glass to Glass Connector	1	Pc	1	1,242	83024110
SS: Stainless Steel AB: Antique Brass PSS: Polished Stainless Steel BL: Black SB: Satin Brass								

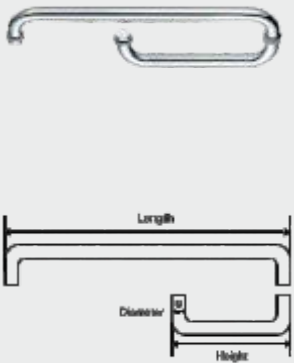
Product	Article No.	SAP	Item Description	Qty.	Unit	PU	MRP	HS Code
Connectors (Material: Stainless Steel 304 with Chrome plating; For 8–10 mm Glass thickness) (96 hours salt spray tested)								
	HGC 01							
	9250733	9250733	HGC 01: 90° Wall to Glass / Floor to Glass PSS Finish	1	Pc	1	600	83024110
	9250809	9250809	HGC 01: 90° Wall to Glass / Floor to Glass SS Finish	1	Pc	1	555	83024110
	HGC 02							
	9250734	9250734	HGC 02: 90° Wall to Glass / Floor to Glass PSS Finish	1	Pc	1	715	83024110
	9250810	9250810	HGC 02: 90° Wall to Glass / Floor to Glass SS Finish	1	Pc	1	650	83024110
	HGC 03							
	9250735	9250735	HGC 03: 90° Glass to Glass Connector PSS Finish	1	Pc	1	930	83024110
	9250811	9250811	HGC 03: 90° Glass to Glass Connector SS Finish	1	Pc	1	875	83024110
	HGC 04							
	9250736	9250736	HGC 04: 180° Glass to Glass Connector PSS Finish	1	Pc	1	930	83024110
	9250812	9250812	HGC 04: 180° Glass to Glass Connector SS Finish	1	Pc	1	875	83024110
Pro-Series Hinges (Material: Brass with Chrome plating; For 8–12 mm Glass thickness) (96 hours salt spray tested)								
	HSH-OWNO							
	9228309	9228309	HSH-OWNO: 90° Glass to Wall Hinge Brass (standard base plate) Loading Capacity 40 kg/pair, Max door width: 750 mm	1	Pc	1	2,549	83024110
	HSH-OWFO							
	9228311	9228311	HSH-OWFO: 90° Glass to Wall Hinge Brass (Eccentric base plate) Loading Capacity 40 kg/pair, Max door width: 750 mm	1	Set	1	2,549	83024110
	HSH-OGAO							
	9228312	9228312	HSH-OGAO: 90° Glass to Glass Hinge Brass Loading Capacity 40 kg/pair, Max door width: 750 mm	1	Set	1	4,081	83024110
	HSH-OGCO							
	9228313	9228313	HSH-OGCO: 135° Glass to Glass Hinge Brass Loading Capacity 40 kg/pair, Max door width: 750 mm	1	Pc	1	4,081	83024110
	HSH-OGDO							
	9228314	9228314	HSH-OGDO: 180° Glass to Glass Hinge Brass Loading Capacity 40 kg/pair, Max door width: 750 mm	1	Pc	1	4,081	83024110
SS: Stainless Steel AB: Antique Brass PSS: Polished Stainless Steel BL: Black SB: Satin Brass								

Product	Article No.	SAP	Item Description	Qty.	Unit	PU	MRP	HS Code
Pro-Series Hinges (Material: Stainless Steel 304 with Chrome plating; For 8–12 mm Glass thickness) (96 hours salt spray tested)								
	HSH-OWNO							
	9250737	9250737	HSH-OWNO: 90° Glass to Wall Hinge SS (standard base plate) Loading Capacity 40 kg/pair, Max door width: 750 mm PSS Finish	1	Pc	1	2,040	83024110
	9250813	9250813	HSH-OWNO: 90° Glass to Wall Hinge SS (standard base plate) Loading Capacity 40 kg/pair, Max door width: 750 mm SS Finish	1	Pc	1	1,815	83024110
	HSH-OWFO							
	9250738	9250738	HSW-OWFO: 90° Glass to Wall Hinge SS (Essentric base plate) Loading Capacity 40 kg/pair, Max door width: 750 mm PSS Finish	1	Pc	1	2,040	83024110
	9250814	9250814	HSW-OWFO: 90° Glass to Wall Hinge (Essentric base plate) Loading Capacity 40 kg/pair, Max door width: 750 mm SS Finish	1	Pc	1	1,815	83024110
	HSH-OGAO							
	9250739	9250739	HSH-OGAO: 90° Glass to Glass Hinge brass SS Loading Capacity 40 kg/pair, Max door width: 750 mm PSS Finish	1	Pc	1	3,245	83024110
	9250815	9250815	HSH-OGAO: 90° Glass to Glass Hinge brass SS Loading Capacity 40 kg/pair, Max door width: 750 mm SS Finish	1	Pc	1	3,015	83024110
	HSH-OGCO							
	9250740	9250740	HSH-OGCO: 135° Glass to Glass Hinge SS Loading Capacity 40 kg/pair, Max door width: 750 mm PSS Finish	1	Pc	1	2,920	83024110
	9250816	9250816	HSH-OGCO: 135° Glass to Glass Hinge SS Loading Capacity 40 kg/pair, Max door width: 750 mm SS Finish	1	Pc	1	2,595	83024110
	HSH-OGDO							
	9250741	9250741	HSH-OGDO: 180° Glass to Glass Hinge SS Loading Capacity 40 kg/pair, Max door width: 750 mm PSS Finish	1	Pc	1	2,920	83024110
	9250817	9250817	HSH-OGDO: 180° Glass to Glass Hinge SS Loading Capacity 40 kg/pair, Max door width: 750 mm SS Finish	1	Pc	1	2,595	83024110
Shower Handles								
	Stainless Steel Shower handles, Finish: Stainless Steel Satin							
	9228316	9228316	HSH 1545/20: Height 150mm, Length 450mm, diameter 20mm Satin SS	1	Set	1	3,060	83024110
	Stainless Steel Shower handles, Finish: Stainless Steel Polished							
	9250416	9250416	HSH 1540/20: Height 150mm, length 400mm, diameter 20mm Polished SS	1	Set	1	3,662	83024110
	9250417	9250417	HSH 1545/20: Height 150mm, length 450mm, diameter 20mm Polished SS	1	Set	1	3,740	83024110
	9250418	9250418	HSH 2040/20: Height 200mm, length 400mm, diameter 20mm Polished SS	1	Set	1	3,740	83024110
	9250419	9250419	HSH 2045/20: Height 200mm, length 450mm, diameter 20mm Polished SS	1	Set	1	3,822	83024110
	9250422	9250422	HSH 2040/25: Height 200mm, length 400mm, diameter 25mm Polished SS	1	Set	1	4,475	83024110
	9250423	9250423	HSH 2045/25: Height 200mm, length 450mm, diameter 25mm Polished SS	1	Set	1	4,594	83024110
	SS: Stainless Steel AB: Antique Brass PSS: Polished Stainless Steel BL: Black SB: Satin Brass							

Product	Article No.	SAP	Item Description	Qty.	Unit	PU	MRP	HS Code
Shower cubicle header Bar and accessories								
	Header Bar							
	9228609	9228609	HSHAC-Tube: Header Bar Length 1200 mm Dia Φ 19 mm Polished Stainless Steel	1	Pc	1	2,907	83024110
	9228611	9228611	HSHAC-Tube: Header Bar Length 2000 mm Dia Φ 19 mm Polished Stainless Steel	1	Pc	1	4,894	83024110
	9228613	9228613	HSHAC-Tube: Header Bar Length 3000 mm Dia Φ 19 mm Polished Stainless Steel	1	Pc	1	7,341	83024110
	Wall Support To Header Bar (Base Material: Brass)							
	9228593	9228593	HSHAC-827: Wall Support To Header Bar Brass, For Φ 19 mm Polished Stainless Steel	1	Pc	1	750	83024110
	9228594	9228594	HSHAC-827: Wall Support To Header Bar Brass, For Φ 19 mm Satin Stainless Steel	1	Pc	1	796	83024110
	Glass End Connector For Header Bar (Base Material: Brass)							
	9228595	9228595	HSHAC-826: Glass End Connector For Header Bar Brass, For Φ 19 mm Polished Stainless Steel	1	Pc	1	794	83024110
	Glass Middle Support For Header Bar (Base Material: Brass)							
	9228597	9228597	HSHAC-825: Glass Middle Support For Header Bar Brass, For Φ 19 mm Polished Stainless Steel	1	Pc	1	858	83024110
	9228598	9228598	HSHAC-825: Glass Middle Support For Header Bar Brass, For Φ 19 mm Satin Stainless Steel	1	Pc	1	918	83024110
	90° Connector For Header Bar (Base Material: Brass)							
	9228599	9228599	HSHAC-327: 90° Connector For Header Bar Brass, For Φ 19 mm Polished Stainless Steel	1	Pc	1	1,286	83024110
	Universal connector for Header Bar (With Adjustable Angle) (Base Material: Brass)							
	9228601	9228601	HSHAC-828: Universal Rail Connector Brass, For Φ 19 mm Polished Stainless Steel	1	Pc	1	1,530	83024110
	T-Connector For Header Bar (Base Material: Brass)							
	9228603	9228603	HSHAC-831: T-Connector For Header Bar Brass, For Φ 19 mm Polished Stainless Steel	1	Pc	1	1,223	83024110

Product	Article No.	SAP	Item Description	Qty.	Unit	PU	MRP	HS Code
	Straight Connector For Header Bar (Base Material: Brass)							
	9228605	9228605	HSHAC-832: Straight Connector For Header Bar Brass, For Φ 19 mm Polished Stainless Steel	1	Pc	1	551	83024110
	135° Connector For Header Bar (Base Material: Brass)							
	9228607	9228607	HSHAC-326: 135° Connector For Header Bar Brass, For Φ 19 mm Polished Stainless Steel	1	Pc	1	1,316	83024110



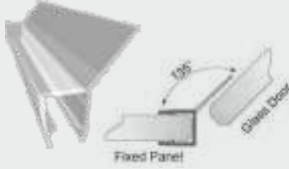
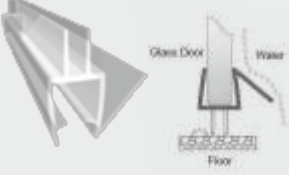
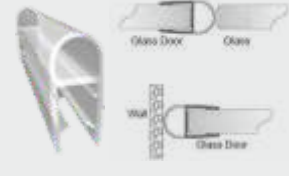
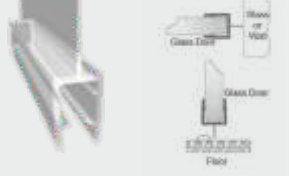
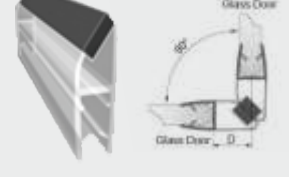
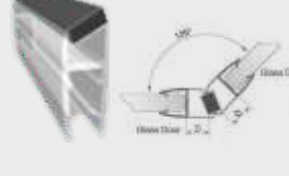
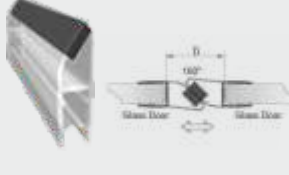
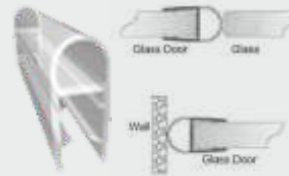





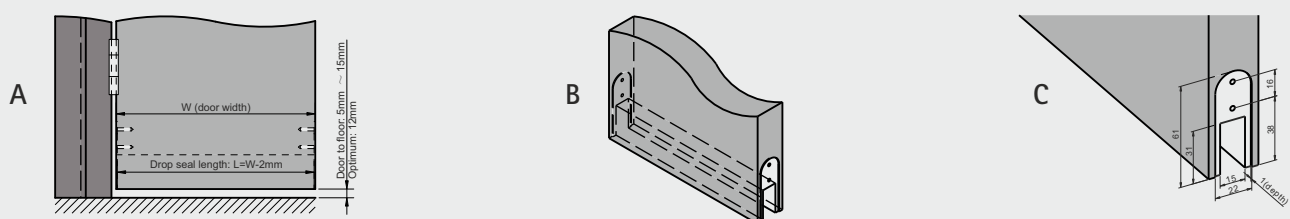





Product	Article No.	SAP	Item Description	Qty.	Unit	PU	MRP	HS Code
Shower Seals (Material: PVC; For 8 & 10 mm Glass thickness)								
	Wall seal for Soft Lip for Glass							
	9228445	9228445	HSDS10-005: For 10 mm glass, 2400 mm length, soft whisker	1	Pc	1	328	83024110
	Wall and Bottom seal for Glass Extruded with water run-off plate							
	9228447	9228447	HSDS10-009: For 10 mm glass, 2400 mm length, soft whisker	1	Pc	1	347	83024110
	Weather Seal used between Door & Side panel opposite to hinge							
	9228449	9228449	HDS10-007: For 10 mm glass, 2400 mm length, soft whisker	1	Pc	1	347	83024110
	Central Glass seal for sealing double action Door & Wall							
	9228451	9228451	HSDS10-001: For 10 mm glass, 2400 mm length, soft whisker	1	Pc	1	347	83024110
	90° Magnetic Seal							
	9228455	9228455	HSDS10-90M: For 10 mm glass, 2400 mm length, soft whisker, Magnet 90°	1	Set	1	1,530	83024110
	135° Magnetic Seal							
	9228453	9228453	HSDS10-135M: For 10 mm glass, 2400 mm length, soft whisker, Magnet 135°	1	Set	1	1,530	83024110
	180° Magnetic Seal							
	9228457	9228457	HSDS10-180M: For 10 mm glass, 2400 mm length, soft whisker, Magnet 180°	1	Set	1	1,530	83024110
	Wall/Glass to Glass Seal 90°							
	9228448	9228448	HSDS 8-007: For 8 mm glass, Wall/Glass to Glass Seal 90°, Weather Seal	1	Set	1	338	39269090







Product	Article No.	SAP	Item Description	Qty.	Unit	PU	MRP	HS Code
	Perimeter seal: Self Adhesive(3M backing tape), Made of Silicone ; Mitigates smoke and sound transmission							
	9228378	9228378	HSQ1-26: D-Shape Self Adhesive, Smoke & Acoustic Seal, Size(H*W-4.5 mm*9 mm),, 50 m, Silicon, Dark Brown	1	Pc	1	4,196	39269090
	Perimeter seal: Groove in type, Made of PVC; Mitigates smoke and sound transmission							
	9250848	9250848	HSili 2: Smoke & Acoustic Seal, Size(H*W-12 mm*6.5 mm), 50 m, PVC, Transparent	1	Pc	1	6,540	39269090
	Perimeter Seal : HPS 1212 P Self Adhesive on 2 sides ; Made of Flexible & Rigid PVC; Mitigates smoke and sound transmission; Anti Bacterial (Suitable for Hospital)							
	9251263	9251263	HPS 1212 P, Smoke&t Aco. Seal, Size: 2400 mm PVC, Brown, Working Temperature : 60 to 250 °C, AntiBacterial (Suitable for Hospital)	1	Pc	1	1,330	40169990
	Intumescent Fire Seal : Self Adhesive (For Wooden and Metal Door)							
	9251296	9251296	HFP 1504: Intumescent Fire Seal, Size: 2400 mm, Moisture resistant Graphite, Brown	1	Pc	1	1,455	40169390
	9251299	9251299	HFP 1004: Intumescent Fire Seal, Size: 2400 mm, Moisture resistant Graphite, Brown	1	Pc	Pc	674	40169390
	Drop Seal : HDS D1 (For Wooden Door)							
	9250605	9250605	HSDS1-1000: For timber doors, 850-1000 mm door width	1	Set	1	1,238	83021090
	9250606	9250606	HSDS1-1200: For timber doors, 1000-1200 mm door width	1	Set	1	1,376	83021090
	Drop Seal : HM1BH EN Certified (For Wooden Door)							
	9251158	9251158	HM1BH: Single Actuation, Self Extinguishing Drop Seal, Length-1083 mm	1	Set	1	4,234	83024190
	9251159	9251159	HM1BH: Single Actuation, Self Extinguishing Drop Seal, Length-1208 mm	1	Set	1	4,793	83024190
	Drop Seal : HM3BH EN Certified (For Metal Door)							
	9251235	9251235	HM3BH: Drop seal, Single Actuation, L1083	1	Set	1	8,529	83024190
	9251236	9251236	HM3BH: Drop seal, Single Actuation, L1208	1	Set	1	8,996	83024190

Automatic drop seal cutouts



Product	Article No.	SAP	Item Description	Qty.	Unit	PU	MRP	HS Code
	Flush Bolt for timber doors							
	9228397	9228397	HFB 1: Flush bolt for Timber Door (200 mm)	1	Pc	1	506	83024110
	9228424	9228424	HFB 1: Flush bolt for Timber Door (300 mm)	1	Pc	1	624	83024110
	Flush Bolt for Metal doors							
	9228398	9228398	HFB 2: Flush bolt for Metal Doors	1	Set	1	610	83024110
	Automatic Flush Bolt							
	9228400	9228400	HFB 4: Automatic Flush Bolt	1	Pc	1	848	83024110
	Dust Proof Socket							
	9228401	9228401	HFBA1: Dust Proof Socket for flush bolt	1	Pc	1	254	83024110
Magnetic Wall Stop								
	HWS75							
	9228402	9228402	HWS 75: Magnetic Wall Stop	1	Set	1	1,121	83024110
	HWS 45							
	9228707	9228707	HWS 45: Magnetic Wall Stop	1	Set	1	762	83024110

Product	Article No.	SAP	Item Description	Qty.	Unit	PU	MRP	HS Code
Pull/Push								
	Pull Plate							
	9228403	9228403	HPP 1: Pull Plate	1	Pc	1	706	83024110
	Push Plate							
	9228404	9228404	HPP2: Push Plate for Door	1	Pc	1	417	83024110
Door Chain/Guard								
	Door Chain							
	9228405	9228405	HDC 1: Door Chain	1	Pc	1	817	83024110
	Door Guard							
	9228708	9228708	HDC 2: Door Guard	1	Pc	1	947	83024110
Pull on Rose								
	Flush Pull on Rose							
	9228406	9228406	HFP 1: Flush Pull-on Rose for Door	1	Pc	1	439	83024110
Door Stopper								
	Door Stopper Floor Mounted							
	9228407	9228407	HDS 44: Door Stopper	1	Pc	1	264	83024110
	Door Stopper Floor Mounted							
	9228408	9228408	HDS 45: Door Stopper	1	Pc	1	352	83024110

Product	Article No.	SAP	Item Description	Qty.	Unit	PU	MRP	HS Code
	Door Drop Stop							
	9228709	9228709	HDS 46: Door Drop Stop	1	Pc	1	632	83024110
	Door Drop Stop							
	9228710	9228710	HDS 47: Door Drop Stop	1	Pc	1	1,040	83024110
	Door Stopper Wall Mounted							
	9250600	9250600	HWS 76: Wall Stop	1	Pc	1	287	83024110
Door Viewer								
	Door Viewer							
	9228410	9228410	HDV 1: Door viewer 180° view (for door thick-35- 55mm)	1	Pc	1	783	83024110
	Door Viewer							
	9228439	9228439	HDV 2: Door viewer 140° view (for door thickness 35-55mm)	1	Pc	1	431	83024110
	9250664	9250664	HDV 2: Door viewer 140° view (for door thickness 35-60mm)	1	Pc	1	499	83024110
	Catalogue							
	9254294	9254294	Architectural Hardware Et Applications Catalogue	1	Pc	1	On Request Only	



* Refer Website

Warranty Clause

For Warranty Regarding Architectural Hardware please refer to below site.
www.hettich.com/in

	Conformité Européenne, meaning "European Conformity"
	European Norm for Fire Protection Certification for Hardware
	European Norm for Door Closing Devices
	European Norm for Door Coordinator Devices
	European Norm for Lever Handles & Knob Furniture
	European Norm for Emergency Exit Locks with Door Handles
	European Norm for Panic Exit Devices
	European Norm for Mechanically Operated Locks, Latches & Locking Plates
	European Norm for Euro Profile Cylinders for Mortise Locks
	European Norm for Hinges

EN STANDARDS		
EN Value	Recommended Door Width (MM)	Recommended Door Weight (KG)
EN 1	750	20
EN 2	850	40
EN 3	950	60
EN 4	1100	80
EN 5	1250	100
EN 6	1400	120
EN 7	1600	160

Approx weight of Door types

Door Type	Mass kg	Duty
Cupboard, wardrobe, cabinet, louvered doors and shutters	3.0–10.0	Light
Light internal large wardrobe and large louvered doors	10.0–17.5	Light
Medium internal doors	17.5–25.0	Medium
Heavy internal doors	25.0–37.5	Medium
Heavy internal doors	40.0–60.0	Heavy
Oversize or special external doors	55.0–110.0	Heavy

The Definition of low, medium and high frequency doors

Building/Door Type	Daily Usage	Frequency
Department store entrance	5000	High
Hospital corridor doors	5000	High
Office Building Entrance	4000	High
School Entrance	1500	High
School Toilet	1500	High
Apartment Entrance (Main Door)	500	High
Office Stairwell	500	High
Office Building Toilet	500	High
School Corridor	100	Medium
Hospital Consultation Room	100	Medium
Office Building Corridor	100	Medium
Storage Room	50	Medium
Residential Entrance	30	Low
Interior Residential	20	Low

Door Weight Calculation

Factors to consider when specifying hinges

- ▶ Is it a fire, smoke or emergency escape door?
- ▶ How heavy is the door and what are the door dimensions (height, width and thickness)?
- ▶ What is the door's construction and are there any unusual features that could affect the hinges?
- ▶ Where is the door situated e.g. internal or external; is it near the coast or in a swimming pool?
- ▶ What level of use/abuse will the door be subject to e.g. office, hospital or school corridor?
- ▶ What other items of hardware are to be fitted, that may affect the hinge performance, typically door closers or door stops?

Forces operating on a door

Two main forces are influencing the performance of the hinge (vertical and the horizontal load).

The vertical load is a result of the gross door weight.

The horizontal load is created by:

- ▶ The door weight
- ▶ The door height to width ratio
- ▶ Where the hinges are positioned.

The wider the door is in relation to its height, the greater the side load that the hinges and their fixings have to support.

Hinges for use with doors of excess width

Wider doors increase the stresses exerted on the hinge. This must be allowed for by a reduction in the maximum mass of the door leaf supported by each class of hinge. The factors by which the door mass has to be adjusted for wider widths are calculated by dividing the door height by its width. For a factor of 2 or greater, no allowance has to be made. The percentage leaf mass increases are shown in the Side Loading calculations in the table:

Side Loading Calculations			
Door Size		Factor	Normal increase of mass of door leaf %
Door Height (mm)	Door Width (mm)		
2000	1000	2.0	0
2000	1050	1.9	10
2000	1100	1.82	18
2000	1150	1.74	26
2000	1200	1.66	33
2000	1250	1.6	40

Example

Door Height = 2100mm

Door Width = 1100mm

Door Weight = 65kg

Factor (Door Height/Door Width) $2100/1100 = 1.9$ this implies increase of door leaf mass by 10%

Adjusted Door Weight

Different factors like a door closer or extra heavy usage are influencing the door weight. Some details for the calculation of the adjusted door weight can be found here:

Adjusted Door Weight Calculation			
Actual Door Weight	Doors of excess width, please refer to Side Loading Calculation table	= Adjusted Door Weight	
	Door closer		+20%
	Door closer (Backcheck)		+75%
	Extra Heavy Use		+10%
	Light Use	- 10%	

Example

height = 2100mm

width = 1100mm

weight = 65kg

+ increase of door leaf mass of 10%

+ installed door closer with back-check = increase of door leaf mass of +75%

= $65\text{kg} + 10\% + 75\% = 125\text{ kg}$ (adjusted door leaf weight)

Horizon HBN - 14 Hinge Application Guidelines

Simply selecting the hinge by door weight alone is very common and not 100% correct. There are many factors influencing determination of the correct number or model of hinges. Most important influencing factors are taken into consideration for the right number of hinges

1. The right number of hinges and maximum door weight

The correct number of hinges is influenced by multiple factors such as

- the door type
- the door weight
- the door height/width ratio (excess width side load)
- the frequency of use
- other door hardware used on the door

In order to make the choice for the right number of hinges easier, the following overview summarizes the maximum door weight with reference to the door width at a height between 2.100 to 2.300 mm.

In many cases two hinges per door will be sufficient to guarantee a smooth performance of the door system. In some cases three hinges per door are used to minimize warping in extremes of temperature or humidity. Hettich also recommends three hinges per door if the actual door weight is very close to the indicated maximum door weight for 2 hinges per door.

Width (in mm)	Max. door weight w/o door closer		Max. door weight w/ door closer		Max. door weight w/ door closer (incorporating back-check and/or hold open device)	
	2 hinges per door	3 hinges per door	2 hinges per door	3 hinges per door	2 hinges per door	3 hinges per door
Max. 750	144 kg	187 kg	120 kg	142 kg	82 kg	97 kg
Max. 850	144 kg	187 kg	120 kg	142 kg	82 kg	97 kg
Max. 950	144 kg	187 kg	120 kg	142 kg	82 kg	97 kg
Max. 1100	131 kg	170 kg	109 kg	129 kg	75 kg	88 kg
Max. 1250	108 kg	141 kg	90 kg	107 kg	62 kg	73 kg
Max. 1400	96 kg	125 kg	80 kg	95 kg	55 kg	65 kg
Max. 1600	85 kg	111 kg	71 kg	84 kg	49 kg	58 kg

Please note: Above maximum door weight indications are based on a perfectly installed and adjusted door system as per EN 1935 test parameters and requirements. Actual values may vary in individual cases. The door system and number of hinges (incl. maximum door weight) may also be influenced by additional hardware installed with the door, the general usage, the correct installation and maintenance. In general, Hettich recommends a trial testing of the door to guarantee an adequate performance.

2 The installation position

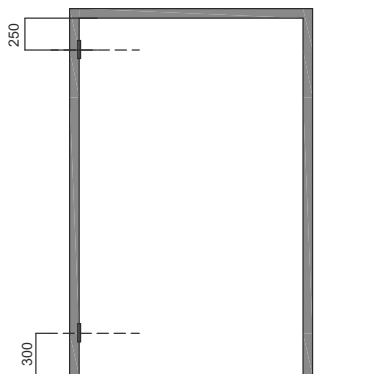

Fig. 1
2 hinges per door

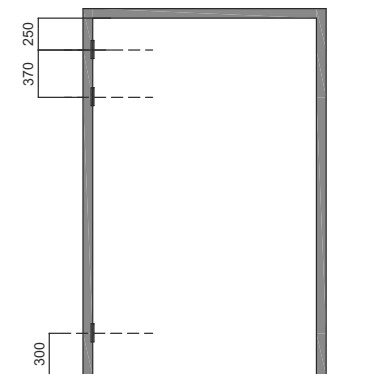

Fig. 2
3 hinges per door

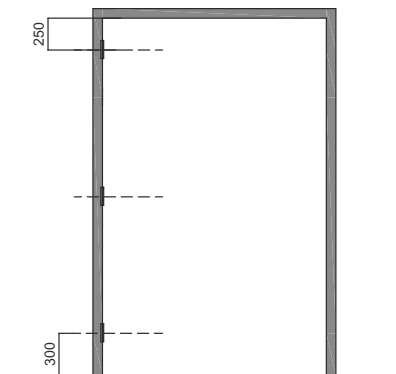

Fig. 3
3 hinges per door

Fig. 1	2 Hinges per door: The new Hettich practice where only two hinges are installed on the door. Hettich recommends to space the hinges as shown. A proper testing is recommended for an adequate door performance as explained Page No 26.
Fig. 2	3 Hinges per door: Where overhead door closers are used, additional lateral forces are applied to the top hinge. Whilst this is taken into consideration within the design calculation, to reduce the lateral force on the top hinge, it is recommended that the hinges are spaced as shown above.
Fig. 3	3 Hinges per door: The standard practice for providing maximum resistance to 'warping' of doors, hinges are spaced as shown above.

3 The definition of low, medium and high frequency doors

Building/Door Type	Daily Usage	Frequency
Department store entrance	5000	High
Hospital corridor doors	5000	High
Office Building Entrance	4000	High
School Entrance	1500	High
School Toilet	1500	High
Apartment Entrance (Main Door)	500	High
Office Stairwell	500	High
Office Building Toilet	500	High
School Corridor	100	Medium
Hospital Consultation Room	100	Medium
Office Building Corridor	100	Medium
Storage Room	50	Medium
Residential Entrance	30	Low
Interior Residential	20	Low

3D Adjustment Hinges: Guidelines & Precautions

3D Adjustment Hinges Installation: Precautions

Things to be remember while Installing 3D Concealed Hinge

- Alignment of the door should be perfectly at 90 degree from floor
- The adjusted door weight to be calculated according to door weight calculation sheet.
- Door dimensions: Door Width: Max 1000 mm Door Height: Max 2400 mm Door Thickness: Max 60 mm
- 3 Nos of hinges are more than enough for doors of adjusted door weight* up to 135 kg

Note:- No more than 3 hinges to be suggested per door *Please calculate adjusted door weight explained on page no.

Weight to Width Ratio Graph

Graph shows weight to width ratio for door without door closer with max 3 Nos of hinges

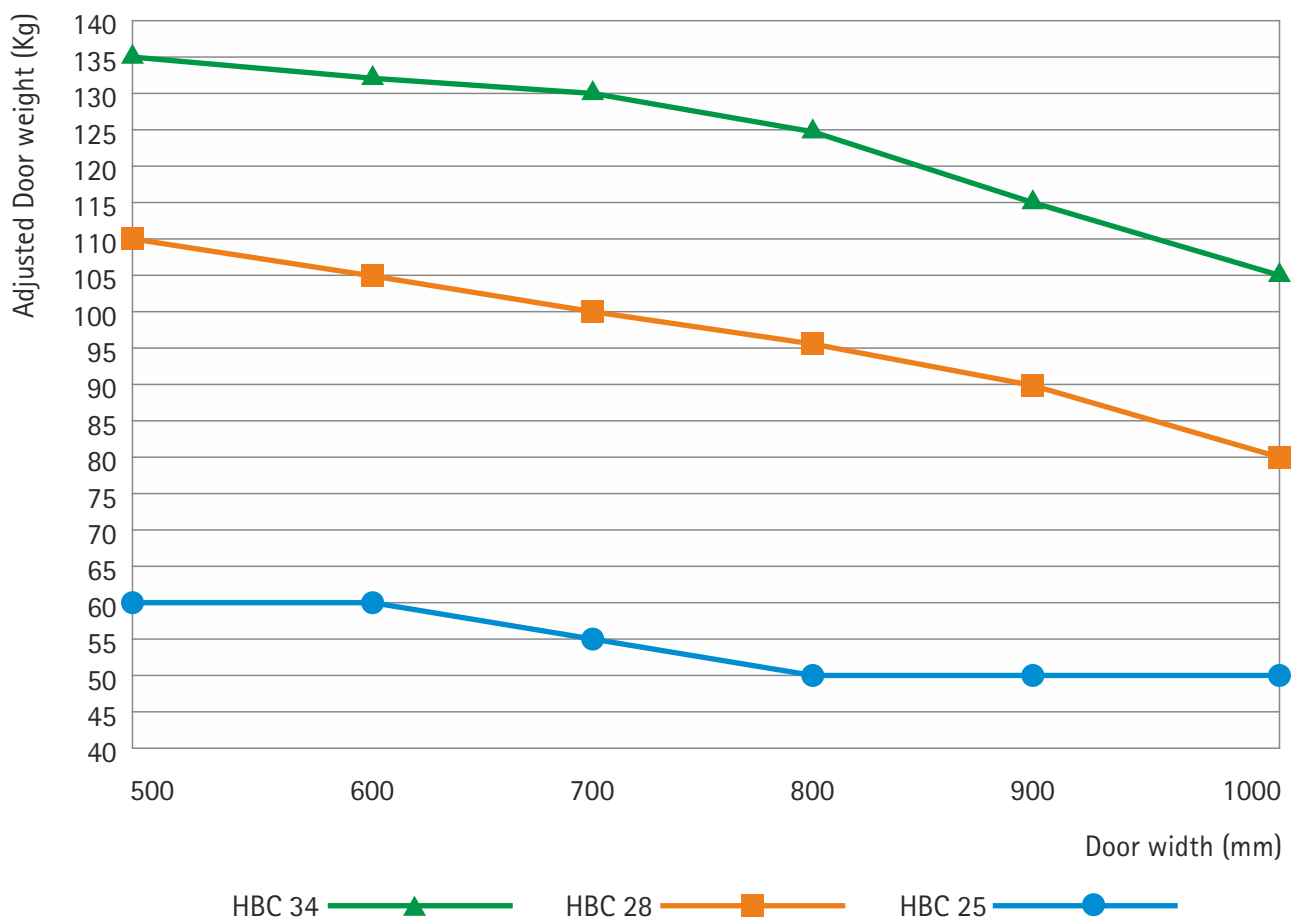

Graph

3D Adjustment Hinges: Guidelines & Precautions

Hinge Position: Diagram

Below are two options for hinges installation:

Installation of the top & bottom hinges first followed by the third hinge according to drawing.

Note: The two hinges at the top carries the major portion of door weight while the bottom hinge completes the door axis

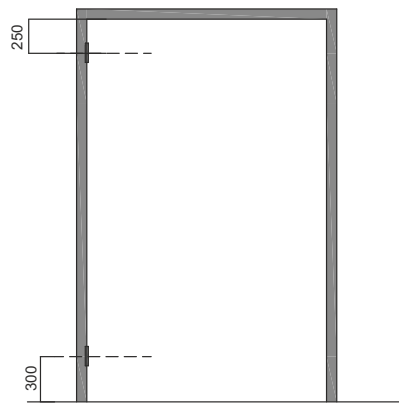

Fig. 1
2 hinges per door

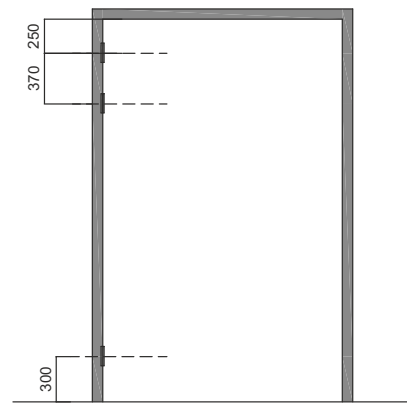
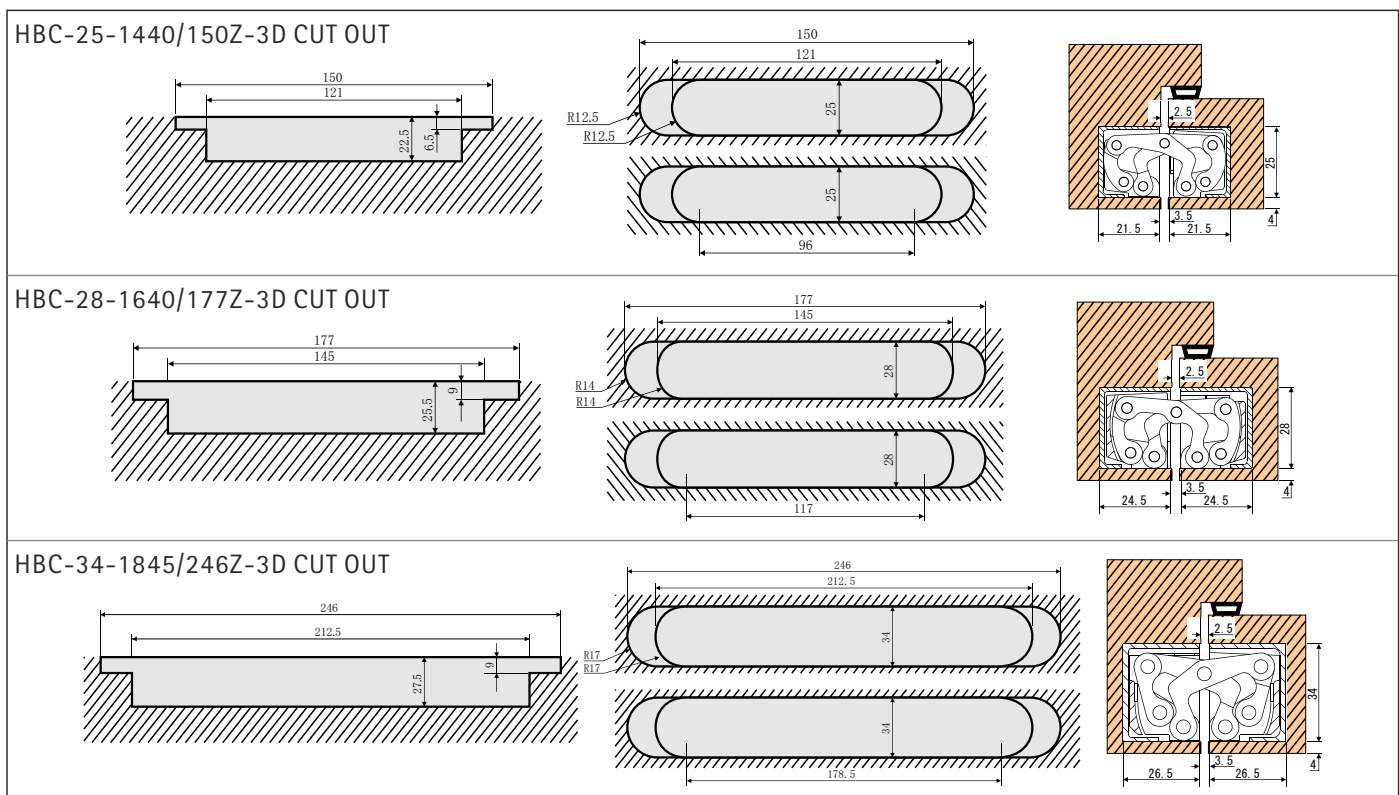

Fig. 2
3 hinges per door

Door Milling Drawings

Please make sure the door cutouts to be made are as per door milling diagrams

Note: Manual cutting may sometimes lead to misalignment and misalignments may hamper the performance of the hinge



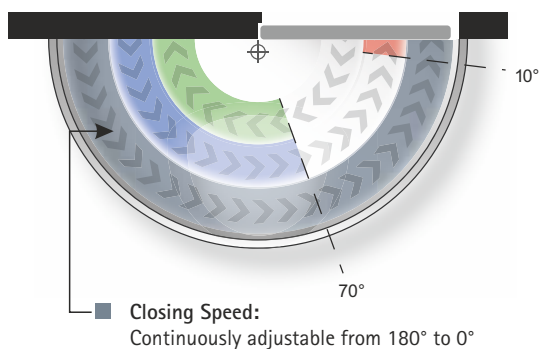

- ▶ **Closing Moment and Closing Speed:** The force generated by a door closing device which acts upon during the closing operation. It helps to adjust closing force according to width & weight of the door
- ▶ **Adjustable Closing Power:** By turning the Hex Notch clockwise or anticlockwise spring strength changes.
- ▶ **Adjustable Closing Speed:** By turning Valve Screw the flow of Liquid can be altered for adjustment of Closing speed.

Valve Adjustment

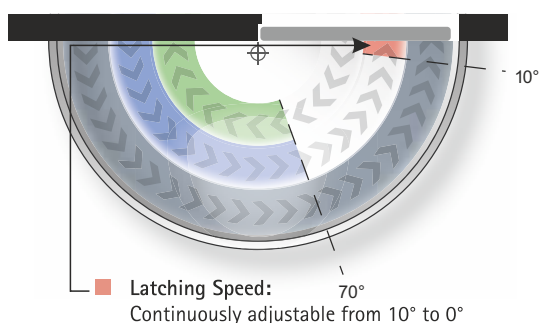

- ▶ **Latching Speed:** A speed control operable to increase the closing speed and thus the safe closing of the door, for example to overcome door seals, door locks and high air pressure. Continuously Adjustable Latching speed ensures perfect latching of all kind of locks.
- ▶ **Latching speed valve:** By turning Valve Screw the flow of Liquid can be further altered for adjustment of Latching speed.

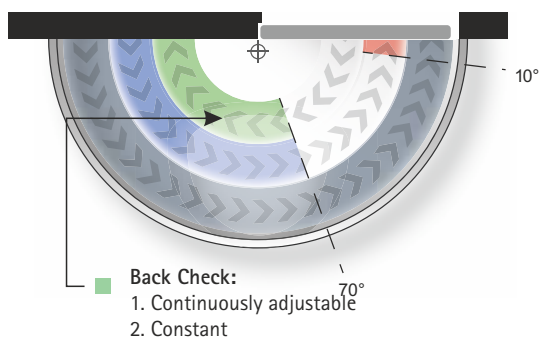

- ▶ **Back Check:** An inbuilt buffer which helps to prevent a door leaf being flung wide open by providing cushioning effect when the door is thrown open. Reduces the opening speed starting at 70° and avoids the slamming of the door.
- Two variants in back check
1. Continuously Adjustable
 2. Constant

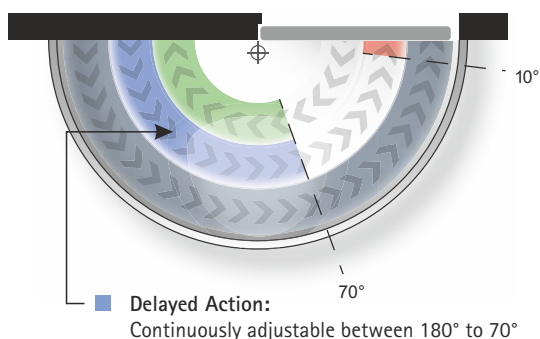

- ▶ **Delayed Action:** An inbuilt function that allows delay in closing door for an adjustable period of time allowing the disabled, elderly people or long trolleys, stretchers to pass through the door unhindered.
- Reduces the closing speed and allows a safer passing for people and transports. Especially suitable for the use in nursing homes and hospitals

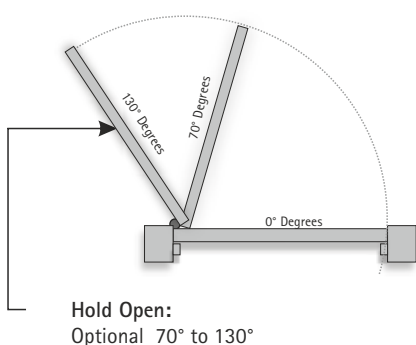

- ▶ **Hold Open:** Additional Feature which ensure self stopping of doors at a certain angle i.e. 70° to 130°. To achieve this additional Component to be added in Slide rail or Standard Arm to be replaced by Hold Open Arm

1. Hold Open Device for Slide Rail



2. Hold Open Arm



Appendix

Hettich Door Closers for every Door width & Usage



SL No	Door Closer Type	Door Closer Description	Image	Article Nos.	Warranty	MRP (Rs.)	Exclusive Features
950 mm (3 ft 2 inches) EN 3							
1	Slide Rail Door Closer	HSS 33 with Slide Rail K (Short Slide Rail)		9227812	5 Years	8,284	Corrosion Resistant Stainless Steel cover, Suitable for outdoor use, 500,000 cycle tested, EN1154 Certified and Fire rated
		HSS 31 with Slide rail B (Long slide rail)		9227810	5 Years	11,426	Corrosion Resistant Stainless Steel cover, Suitable for outdoor use, With Fixed back check, 500,000 cycle tested, EN1154 Certified and Fire rated
	Concealed Door Closer	HCS 380		9227824	5 Years	5,952	Suitable for indoor use, Integrated Hold open function, 500,000 cycle tested, For 40 mm thick door
	Standard Arm Door Closer	Standard Arm Door Closer have Power size in range of 2-4 so we can suggest any EN4 (1100 mm) Door Closer					
1100 mm (3 ft 8 inches) EN 4							
2	Slide Rail Door Closer	HSS 41 with slide rail B (Long Slide rail)		9227808	5 Years	14,053	Corrosion Resistant Stainless Steel cover, Suitable for outdoor use, With Fixed back check, 500,000 cycle tested, EN1154 Certified and Fire rated
	Concealed Door Closer	HCS 385		9227823	5 Years	7,895	Suitable for indoor use, Integrated Hold open function, 500,000 cycle tested, For 40 mm thick door
		HCS 400 with hold open Slide rail		9250843	5 Years	14,410	HCS 400 with hold open Slide rail: EN 2-4, For Door Width 850-1100 mm and Door Weight 40-120 kg; EN1154 Certified; Fire rated; 500,000 cycle tested (Min. Door Thickness - 40 mm)
	Standard Arm Door Closer	HSA 10 F		9227816	5 Years	2,688	Suitable for outdoor use, Fixing Position of Door closer to be changed according to Door size (EN2/3/4), 200,000 cycle tested, Fire rated
		HSA 10 D EN		9227817	5 Years	3,024	Suitable for outdoor use, Fixing Position of Door closer to be changed according to Door size (EN2/3/4), 500,000 cycle tested, EN1154 Certified and Fire rated
		HSA 10		9227818	5 Years	2,592	Suitable for outdoor use, Fixing Position of Door closer to be changed according to Door size (EN2/3/4), 200,000 cycle tested
		HSA 14		9228418	5 Years	4,935	Sliding Removable Ribbed Protective Aluminum cover, Fixing Position of Door closer to be changed according to Door size (EN1/2/3/4) 200,000 cycle tested
	1250 mm (4 ft 2 inches) EN 5						
3	Slide Rail Door Closer	HSS 61 with Slide Rail B (Long Slide rail)		9227802	5 Years	20,707	Corrosion Resistant Stainless Steel Cover, Suitable for outdoor use, Adjustable back check, 500,000 cycle tested EN1154 Certified and Fire rated
	Concealed Door Closer	HCS Multi G		9227820 + 9227825	5 Years	47,254	Suitable for indoor use, Oil free door closer with integrated Hold open function, 500,000 cycle tested, For 40 mm thick door
	Standard Arm Door Closer	HSA 15		9227815	5 Years	6,498	Sliding Removable Ribbed Protective Aluminum Cover, Fixing Position of Door closer to be changed according to Door size (EN 1/2/3/4), 200,000 cycle tested
		HSA 20		9227814	5 Years	7,343	Corrosion Resistant Stainless Steel Cover, Suitable for outdoor use, Fixed back check, 500,000 cycle tested, EN1154 Certified and Fire rated
1400 mm (4 ft 8 inches) EN 6							
4	Slide Rail Door Closer	HSS 61 with Slide Rail B (Long Slide rail)		9227802	5 years	20,707	Corrosion Resistant Stainless Steel Cover, Suitable for outdoor use, Adjustable back check, 500,000 cycle tested, EN1154 Certified and Fire rated

Appendix Maximum Door Mass for Standard Arm Door Closer



Standard Arm Door closer for single leaf doors (Hinge and hinge opposite side)

Maximum Door Width 950 mm

Door closer	Fire rated	Size acc.to EN 1154 A	Adjustable Latching Speed	Adjustable Closing Speed	Back-Check	Delay Action	Max. Door Weight
HSA50	Yes	1-5	✓	✓	✓	-	150 kg
HSA20	Yes	2/3/5	✓	✓	✓	-	150 kg
HSA15	No	2/3/4/5	✓	✓	-	-	100 kg
HSA14	No	1/2/3/4	✓	✓	-	-	80 kg
HSA10 D EN	Yes	2/3/4	✓	✓	-	-	80 kg
HSA10 F	Yes	2/3/4	✓	✓	-	-	80 kg
HSA10	No	2/3/4	✓	✓	-	-	80 kg
HSA10 X	No	3	✓	✓	-	-	60 kg

Maximum Door Width 1100 mm

Door closer	Fire rated	Size acc.to EN 1154 A	Adjustable Latching Speed	Adjustable Closing Speed	Back-Check	Delay Action	Max. Door Weight
HSA50	Yes	1-5	✓	✓	✓	-	140 kg
HSA20	Yes	2/3/5	✓	✓	✓	-	140 kg
HSA15	No	2/3/4/5	✓	✓	-	-	100 kg
HSA14	No	1/2/3/4	✓	✓	-	-	80 kg
HSA10 D EN	Yes	2/3/4	✓	✓	-	-	80 kg
HSA10 F	Yes	2/3/4	✓	✓	-	-	80 kg
HSA10	No	2/3/4	✓	✓	-	-	80 kg

Maximum Door Width 1250 mm

Door closer	Fire rated	Size acc.to EN 1154 A	Adjustable Latching Speed	Adjustable Closing Speed	Back-Check	Delay Action	Max. Door Weight
HSA50	Yes	1-5	✓	✓	✓	-	110 kg
HSA20	Yes	2/3/5	✓	✓	✓	-	110 kg
HSA15	No	2/3/4/5	✓	✓	-	-	100 kg

Note: The door closer power size has to be adjusted to the highest level for any door weight that exceeds the test door weight of EN1154 standard

Appendix Maximum Door Mass for Slide Rail Door Closer



Slide Rail Door closer for single leaf doors (Hinge and hinge opposite side)

Maximum Door Width 950 mm

Door closer	Fire rated	Size acc.to EN 1154 A	Adjustable Latching Speed	Adjustable Closing Speed	Back-Check	Delay Action	Max. Door Weight
HSS-61	Yes	5-6	✓	✓	✓	opt.	250 kg
HSS-61	Yes	2-5	✓	✓	✓	opt.	200 kg
HSS-51	Yes	1-4	✓	✓	✓	-	140 kg
HSS-41	Yes	1-4	✓	✓	✓	-	120 kg
HSS-31	Yes	1-3	✓	✓	✓	-	100 kg
HSS-33	Yes	3	✓	✓	-	-	80 kg

Maximum Door Width 1100 mm

Door closer	Fire rated	Size acc.to EN 1154 A	Adjustable Latching Speed	Adjustable Closing Speed	Back-Check	Delay Action	Max. Door Weight
HSS-61	Yes	5-6	✓	✓	✓	opt.	220 kg
HSS-61	Yes	2-5	✓	✓	✓	opt.	170 kg
HSS-51	Yes	1-4	✓	✓	✓	-	140 kg
HSS-41	Yes	1-4	✓	✓	✓	-	120 kg

Maximum Door Width 1250 mm

Door closer	Fire rated	Size acc.to EN 1154 A	Adjustable Latching Speed	Adjustable Closing Speed	Back-Check	Delay Action	Max. Door Weight
HSS-61	Yes	5-6	✓	✓	✓	opt.	190 kg
HSS-61	Yes	2-5	✓	✓	✓	opt.	140 kg

Maximum Door Width 1400 mm

Door closer	Fire rated	Size acc.to EN 1154 A	Adjustable Latching Speed	Adjustable Closing Speed	Back-Check	Delay Action	Max. Door Weight
HSS-61	Yes	5-6	✓	✓	✓	opt.	160 kg

Note: The door closer power size has to be adjusted to the highest level for any door weight that exceeds the test door weight of EN1154 standard

Appendix Maximum Door Mass for Concealed Door Closer



Concealed Door closer for single leaf doors (Hinge and hinge opposite side)

Maximum Door Width 950 mm

Door closer	Fire rated	Size acc.to EN 1154 A	Adjustable Latching Speed	Adjustable Closing Speed	Back-Check	Delay Action	Max. Door Weight
Multi G	Yes	2-5	✓	✓	-	-	130 kg
Multi G	Yes	1-4	✓	✓	-	-	120 kg
HCS 400	Yes	2-4	✓	✓	-	-	120 kg
HCS 385	No	2-4	✓	✓	-	-	80 kg
HCS 380	No	3	✓	✓	-	-	60 kg

Maximum Door Width 1100 mm

Door closer	Fire rated	Size acc.to EN 1154 A	Adjustable Latching Speed	Adjustable Closing Speed	Back-Check	Delay Action	Max. Door Weight
Multi G	Yes	2-5	✓	✓	✓	-	120 kg
Multi G	Yes	1-4	✓	✓	✓	-	100 kg
HCS 400	Yes	2-4	✓	✓	✓	-	100 kg
HCS 385	No	2-4	✓	✓	✓	-	80 kg

Maximum Door Width 1250 mm

Door closer	Fire rated	Size acc.to EN 1154 A	Adjustable Latching Speed	Adjustable Closing Speed	Back-Check	Delay Action	Max. Door Weight
Multi G	Yes	2-5	✓	✓	-	-	100 kg

Note: The door closer power size has to be adjusted to the highest level for any door weight that exceeds the test door weight of EN1154 standard

Utilization Categories of Door Locks & Handle



Class 1: HOME

Moderate utilization by persons motivated to exercise great care and from whom there is a low risk of improper use. Typical areas of application: interior doors of residential buildings.



Class 2: OFFICE

Moderate utilization by persons motivated to exercise care but from whom there is a certain risk of improper use. Typical areas of application: interior doors of office buildings.



Class 3: PUBLIC PLACES

High utilization by the general public or other persons with low motivation to exercise care and from whom there is a high risk of improper use. Typical areas of application: interior doors of office buildings open to the general public.



Class 4: STADIUM / PUBLIC TOILETS

For use in doors that are frequently subjected to violence or damage. Typical areas of application are Cricket & Football stadium, barracks or public toilets.

Technology Behind Handles

ProLock 4 - Premium handles with ball-bearing technology

ProLock 4

ProLock 4 -bearing

These high-end project handles are characterized by an industrial ball bearing. The precise and maintenance free ball bearing technology ensures a well-balanced system. Additionally the flex-bearing, lying inside the ball bearing unit, balances uneven door surfaces for up to 3 degree. This premium and innovative solution will meet all standards for private or public doors.

- ▶ EN 1906, class 4
- ▶ With spring and 90 degree carrier
- ▶ Patented flex-bearing unit
- ▶ 1 million cycle tested

ProLock 3 - Handles with friction bearing technology

ProLock 3

ProLock 3-bearing

The main characteristic of this handle is a maintenance free nylon bearing that is floating on the steel base rose and balancing radial and axial free-play. This class 4 handle bearing can be used on doors with high frequency and a potential for violent usage such as in schools or Cricket & Football stadium.

- ▶ EN 1906, class 4
- ▶ Unsprung
- ▶ 200,000 cycle tested

ProLock 2 - Handles with standard friction bearing technology

ProLock 2

ProLock 2 -bearing

The bearing made of glass fiber reinforced nylon is guiding the handle axial as well as radial. A wave spring is compensating angular tolerances. A perfect and certified price/performance ratio for frequently used handles in all kind of buildings.

- ▶ EN 1906, class 3
- ▶ With spring
- ▶ 200,000 test cycles

ProLock 1 - Handles with standard friction bearing technology

ProLock 1

ProLock 1 -bearing

The steel base rose and return spring ensure a proper and stable fixing on the door. The economic bearing is perfect for interior doors in public buildings or private houses.

- ▶ With spring
- ▶ 200,000 internal test cycles

Prolock handles: PZ and WC Sets

As mentioned in the Price List, each handle is having two versions with two Article codes as per below :

		Prolock 1 HH 2110 (Hollow)						
		Article Code 1	Article Code 2	Description	Quantity	Set	Price	Article Code
		9228099	9228099	ProLock 1 HH 2110 Handle + Handle set SS	1	Set	1,334	83024110
		9228101	9228101	ProLock 1 HH 2110 Handle + WC Bathroom set SS (Please order only Bathroom Lock along with WC version set)	1	Set	1,934	83024110

What is Handle + handle set and Handle + WC bathroom Set?

The PZ version handles are used for all the locking solutions in which Euro profile cylinders are used for key Locking

PZ version Mortise handle

- For use with Sash Lock, Latch Lock, Night Latch Lock and Panic Lock bodies
- Set comprises of set of Handles, Set f PZ escutcheon and fixing material
- Widely used version of handle
- Available in all handle shapes



The WC version handles are used for bathroom or privacy doors with bathroom handles

WC version Mortise handle

- For use with **only** Bathroom Lockbody
- Set comprises of set of Handles, Set of WC escutcheon with indicator and fixing material
- Less used version of handle mostly where WC escutcheon with indicator is required
- Available in all handle shapes

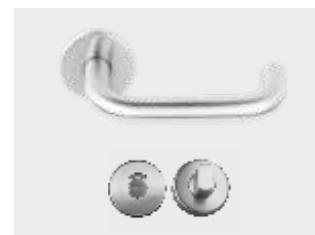

Handing of doors for Lift Off Hinge

Lift Off Hinge illustration for DIN Right & DIN Left hinge and for ordering

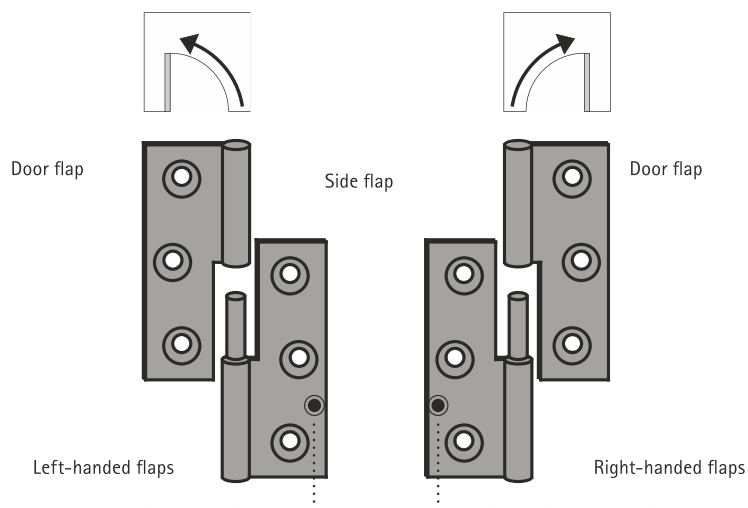

How to determine if the door is DIN Left or DIN Right

What is DIN Left And Right: DIN Right/Left denotes the direction of the opening of the door

DIN Left: When the hinges are placed to the left of the door leaf, then the door is opened DIN left.

DIN Right: When the hinges are placed to the right of the door leaf, then the door is opened DIN right.

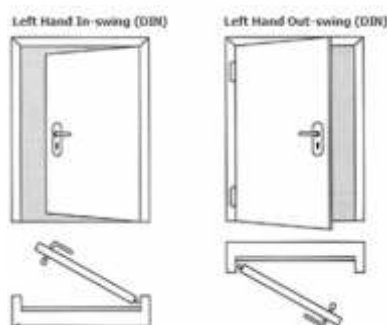
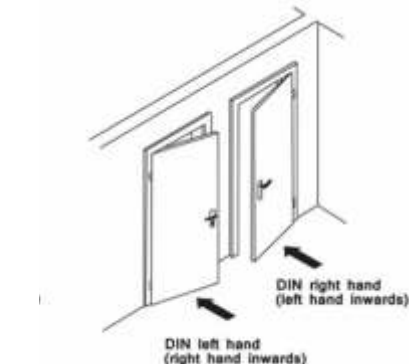

DIN left means Hinge barrel is visible on Left side that means a person will use left hand to operate the door

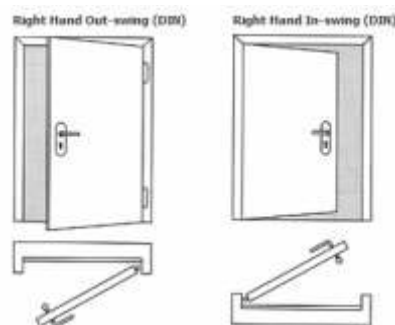
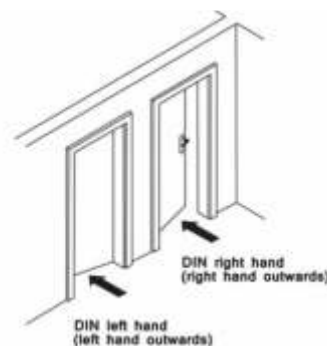

DIN Right means Hinge barrel is visible on right side that means a person will use Right hand to operate the door.

Why we need DIN Left/Right versions?

It is required as the outer handle is fixed and only operable with key that means only inside handle will be moving and hence we need to have different handles motion for DIN Left/Right opening Doors from inside.



DIN Left set

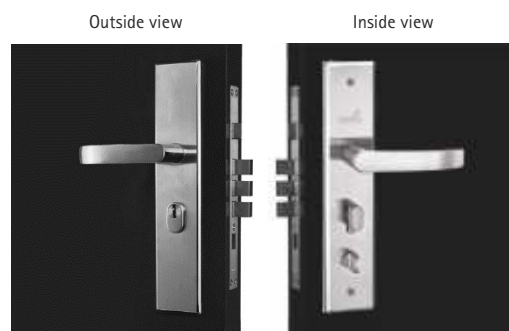

DIN Right set

NOTE: There is no need to order both DIN left and DIN right for a single door.

How to decide article no. while placing Order?

If a person will be using leftward opening door then DIN left will be used. Article no: 9228485 (For SS Finish only)

If a person will be using rightward opening door then DIN right will be used. Article no : 9228501 (For SS Finish only)

Prolock Infinity : The Complete Main Door Solution

	Prolock Infinity Handles Design 1 (HSN Code - 83024110)		Qty.	Unit	PU	MRP
	9250858	Prolock Infinity 1 SS DIN Left - movable	01	Set	01	4,606
	9250886	Prolock Infinity 1 SS DIN Right - movable	01	Set	01	4,606









Same concept applies to all ProLock Infinity Handles Design.

NOTE: There is no need to order both DIN left and DIN right for a single door.

Appendix

Hettich Floor Springs for every door width and weight



Loading Capacity	Floor Spring Description	Image	Article Nos.	Warranty	MRP (Rs.)	Exclusive Features	Ready Reckoner: Glass Door Weight (kg)				
							Thickness (mm)	Height 2100 mm	Height 2400 mm	Height 2700 mm	Height 3000 mm
Door Width: 850 mm (34 inches) EN 2											
150 kg	HTS FS842 (Body):EN2, adjustable closing/ latching speed, HO 90 , without acc., EN1154		9227841	5 years	7,845	Protective Rust proof Stainless Steel cover; Specially made for commercial glass, wooden & profile 850 mm Doors; Door Weight 150 kg; EN 1154 certified; 500,000 cycle tested; For small sized, high traffic doors	10	46	53	60	67
100 kg	HTS FS652 (Body):EN2, adjustable closing/ latching speed, HO 90, without acc.		9227850	5 years	6,433	Protective Rust proof Stainless Steel cover; Specially made for commercial glass, wooden & profile 850 mm Doors; Door Weight 100 kg; 200,000 cycle tested; For small sized, medium traffic doors	12	56	64	72	80
Door Width: 950 mm (38 inches) EN 3											
150 kg	HTS FS843 (Body):EN3, adjustable closing/ latching speed, HO 90, without acc., EN1154		9227844	5 years	7,845	Protective Rust proof Stainless Steel cover; Specially made for commercial and residential glass, wooden & profile 950 mm Doors; Door Weight 150 kg; EN 1154 certified; 500,000 cycle tested; For medium sized, high traffic doors	10	52	60	70	75
100 kg	HTS FS653 (Body):EN3, adjustable closing/ latching speed, HO 90, without acc.		9227853	5 years	6,433	Protective Rust proof Stainless Steel cover; Specially made for commercial and residential glass, wooden & profile 950 mm Doors; Door Weight 100 kg; 200,000 cycle tested; For medium sized, moderate traffic doors					
80 kg	HTS FS463 (Body):EN3, adjustable closing/ latching speed, HO 90 , without acc.		9228444	5 years	4,637	Protective Rust proof Stainless Steel cover; Specially made for commercial and residential glass, wooden & profile 950 mm Doors; Door Weight 80 kg; 200,000 cycle tested; For medium sized, moderate traffic doors	12	63	72	80	88
Door Width: 1100 mm (44 inches) EN 4											
150 kg	HTS FS844 (Body):EN4, adjustable closing/ latching speed, HO 90, without acc., EN1154		9227847	5 years	7,845	Protective Rust proof Stainless Steel cover; Specially made for commercial and residential glass, wooden & profile 1100 mm Doors; Door Weight 150 kg; EN 1154 certified; 500,000 cycle tested; For large high traffic doors	10	60	69	73	86
100 kg	HTS FS654 (Body):EN4, adjustable closing/ latching speed, HO 90, without acc.		9227856	5 years	6,433	Protective Rust proof Stainless Steel cover; Specially made for commercial and residential glass, wooden & profile 1100 mm Doors; Door Weight 100 kg; 200,000 cycle tested; For Large sized, high traffic doors	12	72	83	93	102
Door Width: 1250- 1400 mm (50- 56 inches) EN 5-6											
300 kg	HTS FS 960 (Body): EN 3-6, Adjustable power & closing/ latching, HO 90°, without acc.		9227859	5 years	36,717	Protective Rust proof Stainless Steel cover; Specially made for commercial and residential glass, wooden & profile for up to 1400 mm Doors; DoorWeight 300 kg; EN 1154 certified; 500,000 cycletested; For large high traffic doors	12	92	105	118	132
For Fitting with Glass doors, please order patch fittings (extra)											
For Fitting with wooden and steel/aluminum profile doors, please order "top and bottom pivot (922786300)" extra..											
No hold open version is generally used for ATM and Restaurant doors where closing is must (mostly to conserve AC, ensure privacy and protection from outside dust)											



Registered & Head Office:
Hettich India Private Limited
302, Durolite House,
Opp. SAB TV, New Link Road,
Andheri (West), Mumbai - 400 053
Phone: +91 22 2674 3289/3356/4089
Fax: +91 22 2674 3267

Delhi Office:
Hettich India Private Limited
A-26/4, 1st floor,
Moham Co-operative Industrial Estate,
New Delhi - 110 044
Phone: +91 11 4889 4000, 4889 4005
Fax: +91 11 4889 4044

Production Site - Vadodara:
Hettich India Private Limited
Plot No. 304, Dhanora,
Nandesari Road,
Near ECPL,
Village - Dhanora - 391 346
Dist. - Vadodara, Gujarat

Production Site - Indore:
Hettich India Private Limited
Plot No 1, Sector 5,
Mhow - Neemuch Road,
Opp Lupin Ltd, Pithampur Industrial,
Pithampur - 454 774
Madhya Pradesh

11_2020

Application Centres:

Bangalore:
Adventz Center, Ground Floor 28,
Cubbon Road, Shivaji Nagar,
Bangalore - 560 001
Ph. No. : +91 80 4530 0400,
+91 80 4530 0401

Mumbai:
202/302, Durolite House, Opp. SAB TV,
New Link Road, Andheri (West),
Mumbai - 400 053
Ph.No. : +91 22 2639 9707

New Delhi:
61, Panchkuian Road,
New Delhi - 110 001
Ph. No. : +91 11 2358 0713,
+91 11 2358 4603

Chennai:
"Heavitree", Ground Floor,
47, Spur Tank Road,
Chetpet, Chennai - 600 031
Ph. No. : +91 44 4263 7227

Ahmedabad:
1st Floor, Unit No. 102,
Safal Pegasus,
Anand Nagar,
Ahmedabad - 380 015,
Ph. No. : +91 79 4032 2824

Chandigarh:
2nd Floor, Aspire Tower,
Plot no. 55, Industrial
& Business park, Phase 1,
Chandigarh - 160 002
Ph. No. : +91 172 5012 347

Hyderabad:
" Sai Krishna "
797 - A, 2nd Floor,
Road No. 36, Jubilee Hills,
Hyderabad - 500 034
Ph. No. : +91 40 2355 8994

Indore:
Office No.106 and 107-A,
"Brilliant Titanium",
Plot No.9, Scheme No.78, Part-II,
Indore - 452 010
Ph. No. : +91 96 9168 4480

Kolkata:
2nd Floor, Unit Number 2A,
Tirumala 22,
East Topsia Road,
Kolkata - 700 046
Ph. No. : +91 98310 12054

Kochi:
41/2062D, 2nd Floor
Palarivattom signal
junction, NH 47 By-pass,
Kochi - 682 028
Ph. No. : +91 48 4402 8242

Training Centre Address:
Hettich Poddar Wood Work Institute
Plot No.2, 1st Floor, DLF Industrial Estate-1
Near NHPC Metro Station,
Faridabad- Haryana
Ph: +91 129 4203888
Email: info@hpwwi.com

Enquiry & Customer Services
Toll Free : 1800 209 2096 (office hours)
Email: sales_enquiry@in.hettich.com
customer_services@in.hettich.com
www.hettich.com

Technik für Möbel

Hettich